

flu-con[®]

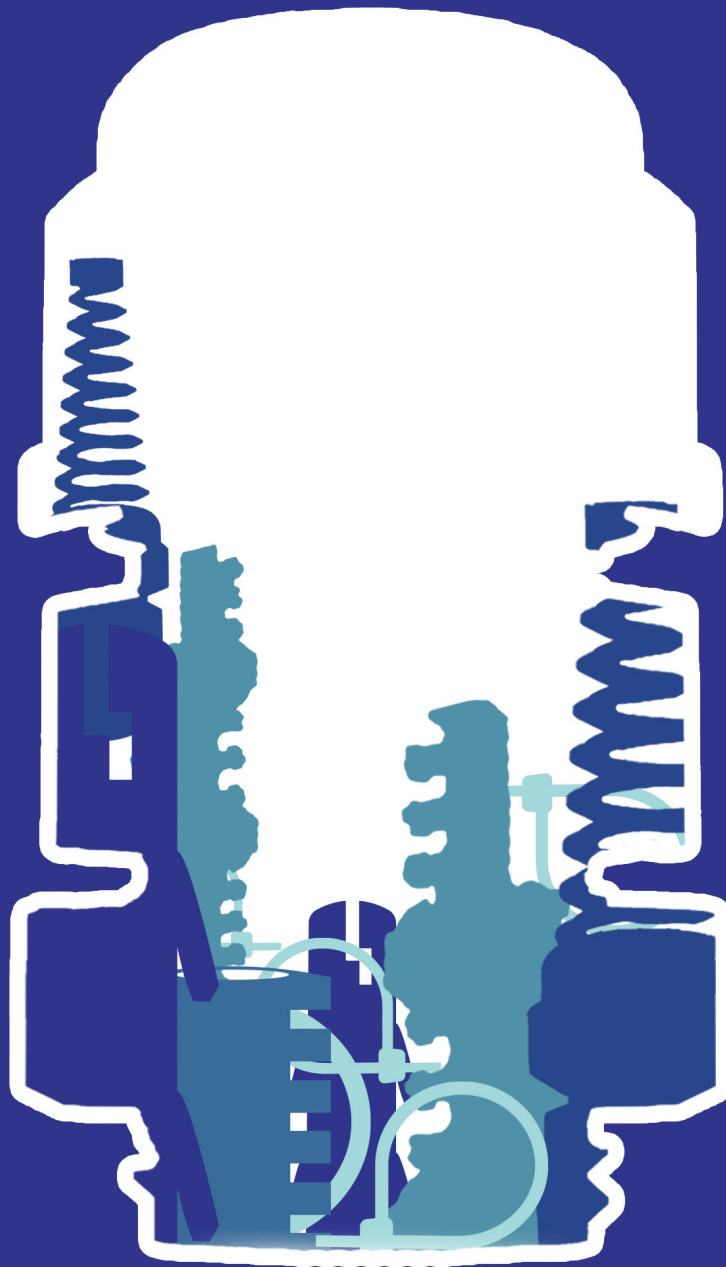

Cable Glands & Blanking Plug

Cable glands are crucial components in electrical and electronic installations. They secure cables to equipment, provide strain relief, and ensure that connections remain safe and protected from environmental factors.

“Flu-Con Provides wide range of cable glands in Metric and PG threads, manufactured and tested as per “BS EN 62444-2013 cable glands for electrical installations.”

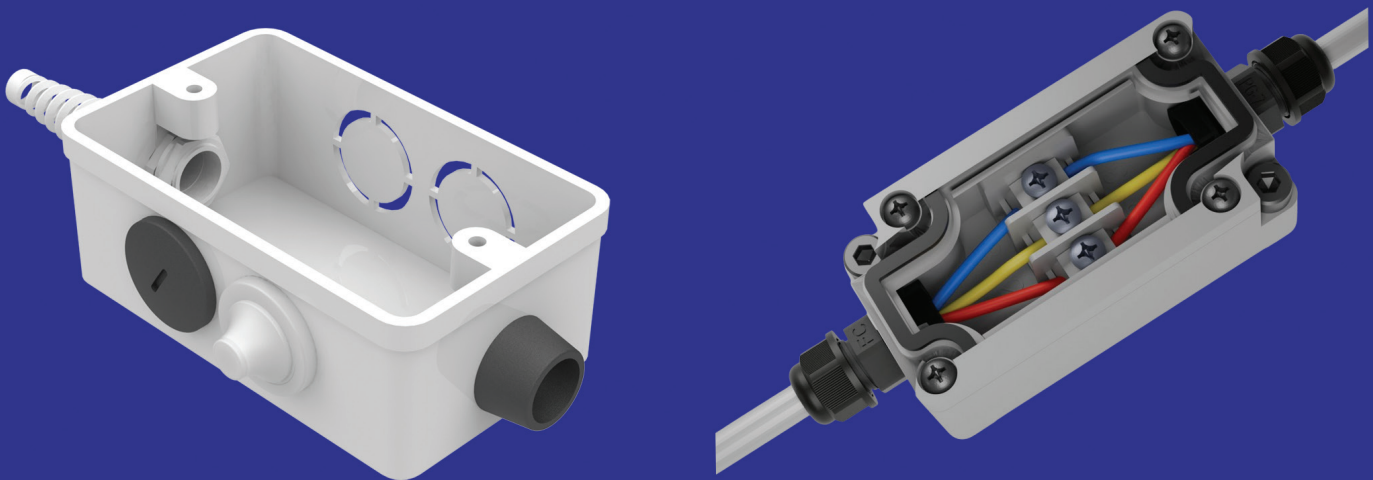

Uses of Cable Glands:

Strain relief: Prevent cables from pulling out or becoming damaged at the connection point.

Environmental protection: Seal cables to block dust, dirt, moisture, or chemicals from entering sensitive equipment.



Nylon Flexible Cable Glands In PG Threads

- **Sealing** : Thermoplastic anti slip rubber (TPR)
- **Temperature range** : Static -10°C to +80°C, Dynamic -30°C to +120°C
- **Ingress protection** : IP 67 without oring & IP 68 with oring
- **Colors** : Silver grey RAL 7001, Light grey RAL 7035 & black RAL 9005
- **Certification/Standards** : RoHS/REACH compliant / CE / DIN 46230
- **Abbreviation** : L = Long thread TC = Twin cable BC= Big cap

Flucon also provides fire resistance cable glands FR UL 94 V0 (960 Glowire) made to order MOQ applicable.

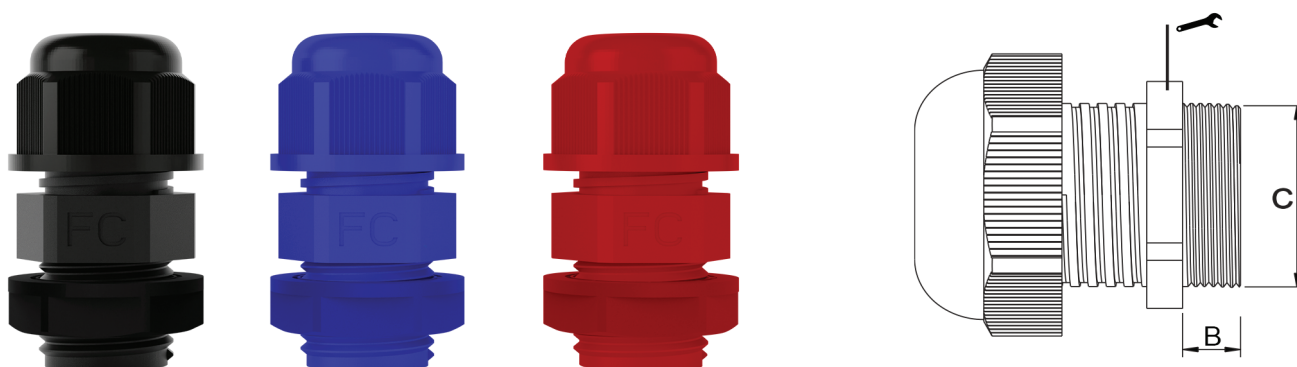

Part Code	Part Description	Cable Range		Dimensions			Packing (Pcs)		MRP Per PC Regular	MRP Per PC FR V2
		Min	Max	mm	B mm	Ø C mm	Inner Carton	Master Carton	Rs.	Rs.
FCFGFCG0003	FCPG-7	3.5	6.5	15	9.00	12.00	100	2000	13.00	17.00
FCFGFCG0010	FCPG-9	5.5	8.0	18	10.00	15.20	100	2000	17.00	23.00
FCFGFCG0017	FCPG-11	7.0	10.0	22	10.00	18.30	100	1000	20.00	27.00
FCFGFCG0023	FCPG-13.5	8.0	12.0	24	10.00	20.00	25	500	21.00	28.00
FCFGFCG0033	FCPG-16	10.0	14.0	27	10.00	22.50	25	500	29.00	39.00
FCFGFCG0138	FCPG-19	12.0	15.0	27	10.00	23.60	25	500	31.00	42.00
FCFGFCG0040	FCPG-21	14.0	18.0	33	11.00	28.50	25	500	39.00	52.00
FCFGFCG0046	FCPG-29	19.0	25.0	42	12.00	36.70	25	250	60.00	81.00
FCFGFCG0051	FCPG-36	25.0	32.0	54	13.00	47.00	10	100	105.00	142.00
FCFGFCG0056	FCPG-42	32.0	38.0	59	21.00	53.00	5	50	140.00	189.00
FCFGFCG0061	FCPG-48	38.0	42.0	65	21.00	59.00	5	50	160.00	216.00
FCFGFCG0067	FCPG-63	40.0	50.0	74	29.00	70.00	4	40	220.00	279.00



CE Certified Nylon Flexible Cable Glands In MM Threads

- Manufactured as per EN62444-2013 cable glands for electrical installations
- **Body:** Nylon 6
- **Sealing:** Thermoplastic
- **Temperature range:** Dynamic -10 °C to +80 °C Static -30 °C to +120 °C
- **Ingress protection** : IP 67 without oring & IP 68 with oring
- **Colors** : Silver grey RAL 7001, light grey RAL 7035 & black RAL 9005
- **Certification/Standards** : RoHS/REACH compliant / CE / EN62444-2013
- **Type tested from NABL accredited body**

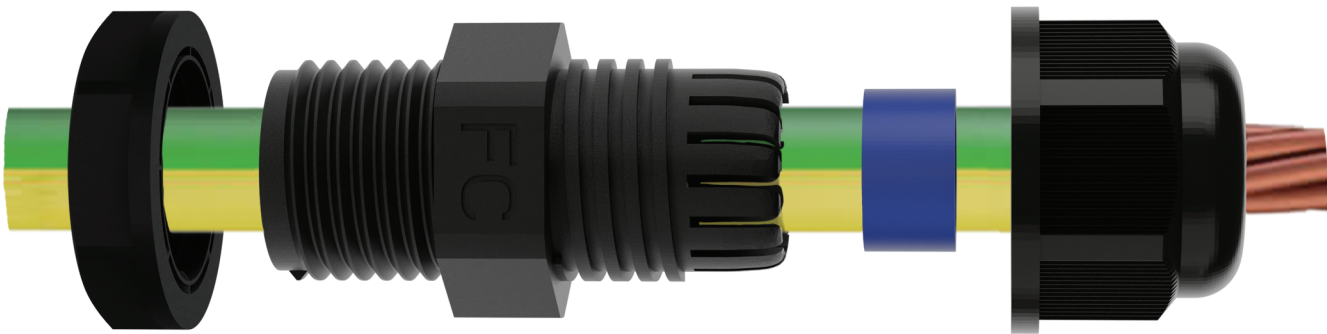

Part Code	Part Description	Cable Range		Dimensions			Packing (Pcs)		MRP Per Pcs Regular	MRP Per Pcs FR V2
		Min	Max		B	Ø C	Inner Carton	Master Carton	Rs.	Rs.
FCFGFCG0072	FCM12X1.5	3.5	6.5	15	9.00	12.00	100	2000	13.00	18.00
FCFGFCG0079	FCM16X1.5	7	10	22	10	16.00	100	2000	17.00	23.00
FCFGFCG0088	FCM20X1.5	8.0	12.0	24	9.00	20.00	25	500	21.00	28.00
FCFGFCG0107	FCM25X1.5	10.0	14.0	27	10.00	25.00	25	500	28.00	37.00
FCFGFCG0115	FCM32X1.5	14.0	18.0	37	10.00	32.00	25	500	44.00	60.00
FCFGFCG0124	FCM40X1.5	14.0	25.0	45	10.00	40.00	10	250	82.00	111.00
FCFGFCG0129	FCM50X1.5	19.0	32.0	54	12.50	50.00	5	50	105.00	142.00



Nylon Flexible Cable Glands In Long Threads.

- Flucon long thread cable glands are designed to be compatible to ABS enclosures, limit switches and enclosures where the thickness of wall is more than 3mm.

Part Code	Part Description	Cable Range		⚙️	Dimensions		Packing (Pcs)		MRP Per PC Regular	MRP Per Pcs FR V2
		Min	Max		B	Ø C	Inner Carton	Master Carton	Rs.	Rs.
FCFGFCG0222	FCPG-7 L	3.5	6.5	15	13.00	12.00	100	2000	16.00	22.00
FCFGFCG0223	FCPG-9 L	5.5	8.0	18	13.00	15.20	100	2000	20.00	27.00
FCFGFCG0224	FCPG-11 L	7.0	10.0	22	13.00	18.30	100	1000	24.00	33.00
FCFGFCG0024	FCPG-13.5 L	8.0	12.0	24	13.00	20.00	25	500	24.00	33.00
FCFGFCG0034	FCPG-16 L	10.0	14.0	27	15.00	22.50	25	500	33.00	45.00
FCFGFCG0225	FCM12X1.5 L	3.5	6.5	15	13.00	12.00	100	2000	16.00	22.00
FCFGFCG0079	FCM16X1.5 L	5.5	8.0	18	13.00	16.00	100	2000	20.00	27.00
FCFGFCG0088	FCM20X1.5 L	8.0	12.0	24	13.00	20.00	25	500	24.00	33.00
FCFGFCG0107	FCM25X1.5 L	10.0	14.0	27	15.00	25.00	25	500	33.00	45.00

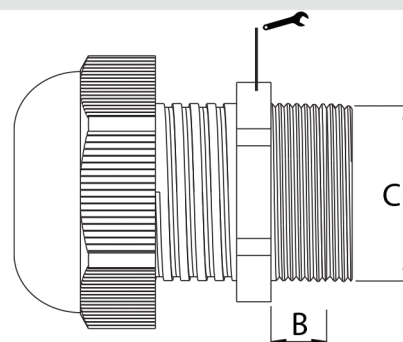

- Flucon NPT threaded and special requirement glands

Part Code	Part Description	Cable Range		⚙️	Dimensions		Packing (Pcs)		MRP Per PC Regular	MRP Per Pcs FR V2
		Min	Max		B	Ø C	Inner Carton	Master Carton	Rs.	Rs.
FCFGFCG0130	FCNPT-1/2"	7.0	12.0	24	14.00	21.00	25	500	24.00	32.00
FCFGFCG0136	FCNPT- 3/4"	13.0	18.0	35	14.00	26.70	25	500	36.00	48.00
FCFGFCG0097	FCM20X1.5 TC	8.0	12.0	27	14.00	20.00	25	500	52.00	70.00
FCFGFCG0105	FCM25X1.5 BC	14.0	18.0	34	14.50	25.00	25	500	41.00	55.00
FCFGFCG0229	FCM16X1.5/PG-11	7.0	10.0	22	10.00	18.30	100	500	24.00	32.00



Spiral Cable Glands

- **Raw material** : Body - polyamide 6
- **Sealing** : Anti slip thermo plastic rubber (TPR)
- **Temperature** : Static -10°C to +80°C, Dynamic -30°C to +120°C,
- **Ingress protection** : IP 67 without oring & IP 68 with oring
- **Colors** : Silver grey RAL 7001, light grey RAL 7035 & black RAL 9005
- **Certification/ Standards** : RoHS/REACH Compliant / CE / DIN 46230 / EN62444-2013

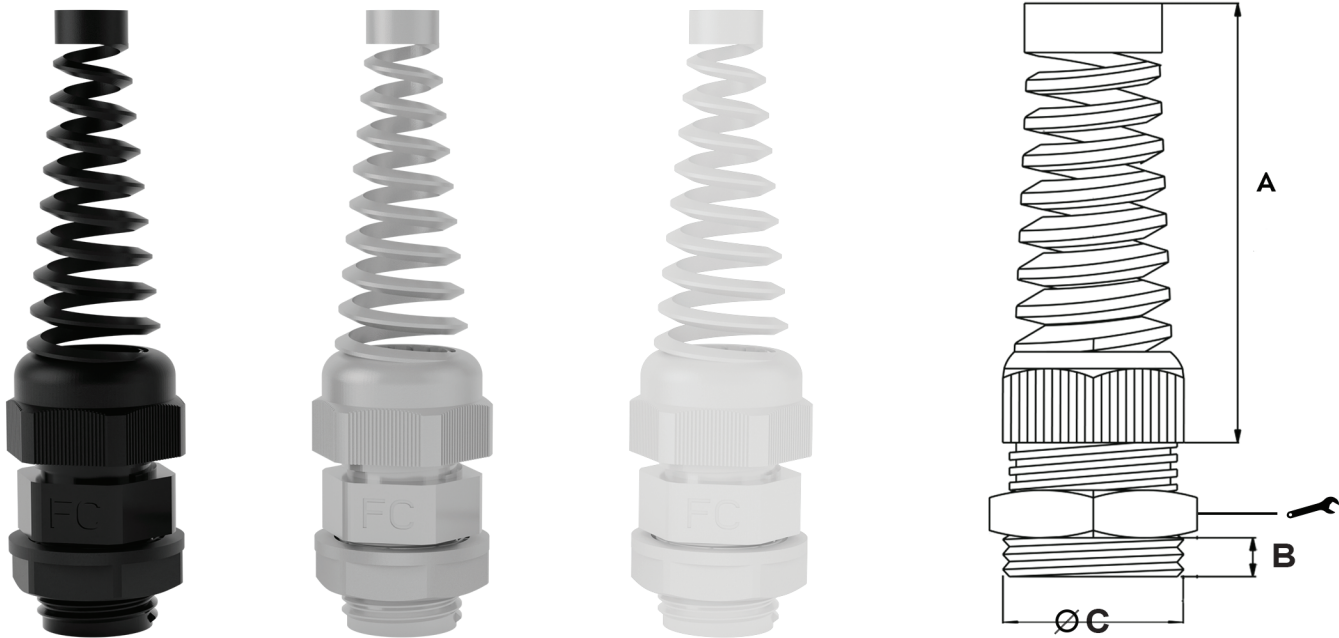

Part Code	Part Description	Cable Range		Wrench	Dimensions			Packing		MRP Per Pcs
		Min	Max		A	B	ØC	Inner Carton	Master Carton	
		mm		mm	mm	mm	mm			Rs.
FCFGNLN0029	FCSCG-7	3.5	6.5	15	47.00	9.00	12.00	100	500	50.00
FCFGNLN0032	FCSCG-9	5.5	8.0	18	56.00	10.00	15.20	100	500	57.00
FCFGNLN0002	FCSCG-11	7.0	10.0	22	67.00	10.00	18.30	100	500	63.00
FCFGNLN0005	FCSCG-13.5	8.0	12.0	24	74.00	10.00	20.00	25	500	75.00
FCFGNLN0008	FCSCG-16	10.0	14.0	27	87.00	10.00	22.50	25	500	88.00
FCFGNLN0011	FCSCG-21	14.0	18.0	33	105.00	12.00	28.50	25	500	125.00
FCFGNLN0014	FCSCG-M12X1.5	3.5	6.5	15	47.00	9.00	12.00	100	500	51.00
FCFGNLN0017	FCSCG-M16X1.5	5.5	8.0	18	56.00	10.00	16.00	100	500	55.00
FCFGNLN0020	FCSCG-M20X1.5	8.0	12.0	24	74.00	10.00	20.00	25	500	77.00
FCFGNLN0023	FCSCG-M-25X1.5	10.0	14.0	27	87.00	10.00	25.00	25	500	92.00
FCFGNLN0026	FCSCG-M32x1.5	14.0	18.0	37	105.00	10.00	32.00	25	500	130.00





Hex Locknut in Metric & PG Threads

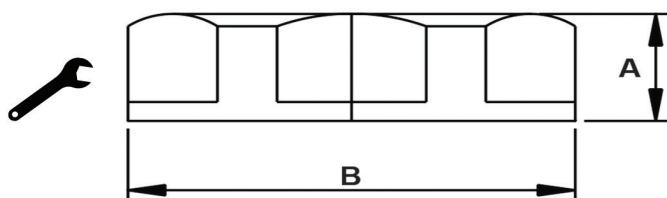

- Raw material : Polyamide 6
- Colors Available : Silver grey RAL 7001, light grey RAL 7035, black RAL 9005
- Ingress protection : IP - 54
- Compatible with : FLUCON cable glands & blanking plugs

Also available in UL approved fire resistance , UV and polyamide 6.6 materials made to order.



Part Code	Part Description	A	B		Packing Per Pac	MRP Per Pkt
		mm	mm	mm	Pcs	Rs.
FCFGNLN0029	FCLN-PG7	5.98	18.30	17	100	345.00
FCFGNLN0032	FCLN-PG9	5.50	21.44	20	100	425.00
FCFGNLN0002	FCLN-PG11	5.50	24.31	22	100	430.00
FCFGNLN0005	FCLN-PG13.5	6.00	30.00	27	100	550.00
FCFGNLN0008	FCLN-PG16	6.00	33.50	31	100	600.00
FCFGNLN0011	FCLN-PG21	7.00	39.00	36	100	800.00
FCFGNLN0014	FCLN-PG29	6.60	49.82	47	100	1160.00
FCFGNLN0017	FCLN-PG36	7.75	66.50	60	100	1800.00
FCFGNLN0020	FCLN-PG42	8.20	66.00	61	100	2000.00
FCFGNLN0023	FCLN-PG48	9.00	78.66	71	100	2700.00
FCFGNLN0026	FCLN-PG63	9.13	81.12	82	100	3000.00
FCFGNLN0035	FCLN-M12X1.5	5.98	18.30	16	100	350.00
FCFGNLN0038	FCLN-M16X1.5	5.50	21.40	20	100	415.00
FCFGNLN0041	FCLN-M20X1.5	6.00	30.00	27	100	550.00
FCFGNLN0044	FCLN-M25X1.5	6.00	33.50	32	100	590.00
FCFGNLN0047	FCLN-M32X1.5	7.00	39.00	37	100	800.00
FCFGNLN0050	FCLN-M40X1.5	6.80	53.40	50	100	1350.00
FCFGNLN0053	FCLN-M50X1.5	8.00	58.00	60	100	2200.00
FCFGNLN0055	FCLN-M63X1.5	9.50	78.00	71	100	3000.00



Blanking Plugs in PG Threads

- **Raw materials :** Polyamide 6
- **Colors available:** Grey Ral 7001, light grey 7035, black 9001



Ingress protection: IP - 65

(IP 67 with rubber 'O' ring available at additional cost)

Blanking Plugs are used to plug holes where existing threading is provided or for plain holes like in panels. They are used to prevent ingress protection during transportation or use of the apparatus.

Part Code	Part Description	Threading Type	Dimensions			Packing Per Pkt	MRP Per Pkt.
			A	B	Ø C		
			mm	mm	mm	Pcs	Rs.
FCFGPBP0028	FCBP-7	PG-7	6.11	10.11	12.48	100	600.00
FCFGPBP0031	FCBP-9	PG-9	9.00	12.63	14.85	100	750.00
FCFGPBP0001	FCBP-11	PG-11	6.00	10.00	18.30	100	710.00
FCFGPBP0004	FCBP-13.5	PG-13.5	9.80	14.20	20.00	100	792.00
FCFGPBP0007	FCBP-16	PG-16	9.11	12.90	22.50	100	810.00
FCFGPBP0010	FCBP-21	PG-21	12.40	16.38	28.00	100	1050.00
FCFGPBP0013	FCBP-29	PG-29	17.50	12.00	36.70	100	1900.00
FCFGPBP0016	FCBP-36	PG-36	9.81	14.97	46.80	100	2400.00
FCFGPBP0019	FCBP-42	PG-42	11.90	18.04	50.00	100	3275.00
FCFGPBP0022	FCBP-48	PG-48	11.80	15.50	60.00	100	4050.00

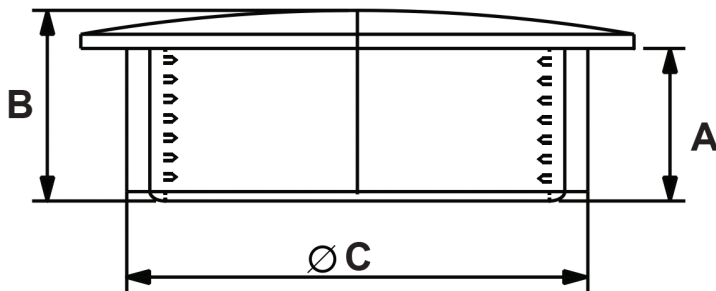



Blanking Plugs in Metric Threads

- **Raw materials :** Polyamide 6
- **Colors available:** Grey Ral 7001, light grey Ral 7035, black Ral 9005
- **Ingress protection:** IP - 65 (IP 67 with rubber 'O' ring available at additional cost)

Part Code	Part Description	Threading Type	Dimensions			Packing Per Pkt	MRP Per Pkt.
			A	B	Ø C		
			mm	mm	mm	Pcs	Rs.
FCFGPBP0028	FCBP-M12X1.5	M-12x1.5	8.94	11.93	11.55	100	600.00
FCFGPBP0031	FCBP-M16X1.5	M-16x1.5	8.57	12.56	15.58	100	750.00
FCFGPBP0001	FCBP-M20X1.5	M-20x1.5	9.80	14.23	19.74	100	810.00
FCFGPBP0004	FCBP-M25X1.5	M-25x1.5	11.00	15.00	24.62	100	950.00
FCFGPBP0007	FCBP-M32X1.5	M-32x1.5	11.00	15.00	31.48	100	2100.00
FCFGPBP0010	FCBP-M40X1.5	M-40x1.5	12.18	17.50	39.67	100	2500.00
FCFGPBP0013	FCBP-M50X1.5	M-50x1.5	12.16	18.40	49.53	100	3000.00
FCFGPBP0016	FCBP-M63X1.5	M-63x1.5	13.41	18.53	62.20	100	4100.00

Push Type Hole Blanking Plugs for Large Diameters

- **Raw material :** LD plastic
- **Temperature range :** -10°C to +60°C
- **Colour :** Black RAL 9005
- **Hardness :** 60 to 65 SHORE 'D'

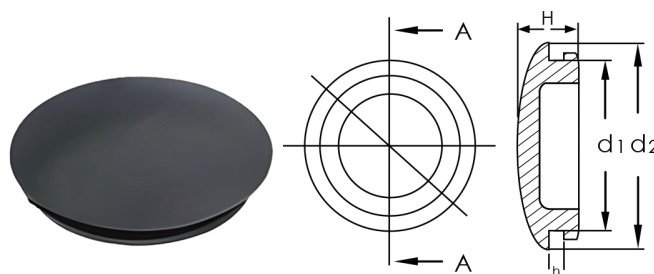

Part Code	Part Description	D1	D2	h	H	Packing Per Carton	MRP Per Pkt.
						Pcs	Rs.
FCFGQA0001	PVC FCBP - 64 X 2.2 MM	66	64	2.2	12	100	2720.00
FCFGQA0002	PVC FCBP - 78 X 3.2 MM	80	78	3.2	12	100	2960.00
FCFGQA0003	PVC FCBP - 78 X 6.7 MM	80	78	6.7	12	100	2960.00
FCFGQA0004	PVC FCBP - 87 X 2.8 MM	88	86	2.8	12	100	3133.00



Brass Flexible Cable Glands in Metric & PG Threads

- **Body** : Brass tin plated, inner body nylon
- **Sealing** : Anti slip TPR
- **Colors available** : Silver
- **Ingress protection** : IP - 68 with rubber 'O' ring



Brass flexible cable glands in metric & PG Threads are used to fasten and secure the entry of cable in control panels and equipments to prevent the cable from moving freely and also provide's adequate ingress protection to the equipments.

Brass cable glands are also used where earthing and EMC protection is necessary.

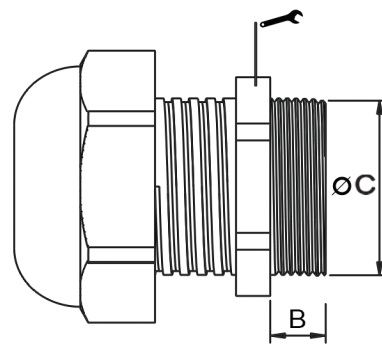

Part Code	Part Description	Threading Type	Cable Range		Key	B	ØC	Packing Per Pkt	MRP Per Pcs
			Min	Max					
			mm	mm					
FCFGBCG001	FCBCG-PG7 BRASS GLAND	PG-7	3.5	6.5	14.02	6.5	12.48	50	125.00
FCFGBCG002	FCBCG-PG9 BRASS GLAND	PG-9	5.5	8.0	17.00	8.0	14.85	50	162.00
FCFGBCG003	FCBCG-PG11 BRASS GLAND	PG-11	7.0	10.0	20.00	10.0	18.30	50	225.00
FCFGBCG004	FCBCG-PG13.5 BRASS GLAND	PG-13.5	8.0	12.0	22.00	12.0	20.00	50	257.50
FCFGBCG005	FCBCG-PG16 BRASS GLAND	PG-16	10.0	14.0	24.00	14.0	22.50	25	285.00
FCFGBCG006	FCBCG-PG21 BRASS GLAND	PG-21	15.0	19.0	30.00	19.0	28.00	25	440.00
FCFGBCG007	FCBCG-PG29 BRASS GLAND	PG-29	19.0	25.0	40.00	25.0	36.70	25	832.50
FCFGBCG008	FCBCG-PG36 BRASS GLAND	PG-36	25.0	32.0	50.00	32.0	46.80	25	1210.00
FCFGBCG019	FCBCG-PG42 BRASS GLAND	PG-42	32.0	38.0	57.00	38.0	50.00	5	1705.00
FCFGBCG009	FCBCG-PG48 BRASS GLAND	PG-48	38.0	42.0	64.00	42.0	60.00	5	2352.00
FCFGBCG012	FCBCG-M12X1.5 BRASS GLAND	M-12x1.5	3.5	6.5	14.0	6.5	11.55	100	132.50
FCFGBCG013	FCBCG-M16X1.5 BRASS GLAND	M-16x1.5	5.5	8.0	18.00	8.0	15.58	100	220.00
FCFGBCG014	FCBCG-M20X1.5 BRASS GLAND	M-20x1.5	8.0	12.0	22.00	12.0	19.74	100	290.00
FCFGBCG015	FCBCG-M25X1.5 BRASS GLAND	M-25x1.5	10.0	14.0	27.00	14.0	24.62	100	435.00
FCFGBCG016	FCBCG-M32X1.5 BRASS GLAND	M-32x1.5	14.0	18.0	34.50	18.0	31.48	100	655.00
FCFGBCG017	FCBCG-M40X1.5 BRASS GLAND	M-40x1.5	14.0	25.0	43.00	25.0	39.67	100	1170.00
FCFGBCG018	FCBCG-M50X1.5 BRASS GLAND	M-50x1.5	19.0	32.0	55.00	32.0	49.53	100	2007.50



Brass Hex Locknut in Metric & PG Threads



- **Raw material** : Brass nickle plated
- **Colors available** : Silver
- **Ingress protection** : IP - 67 with suitable glands or blanking plugs
- **Compatibility** : Flucon conduit glands, blanking plugs, brass flexible glands

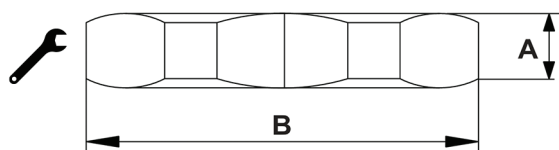

PG Threads

Part Code	Part Description	Dimensions			Packing Per Pkt	MRP Per Pcs
		A	B			
		mm	mm	mm	Pcs	Rs.
FCFGBLN001	FCPG-7 BRASS NUT NICKLE PLATED	2.8	16.6	15	100	16.00
FCFGBLN002	FCPG-9 BRASS NUT NICKLE PLATED	2.8	20.0	18	100	18.00
FCFGBLN018	FCPG-11 BRASS NUT NICKLE PLATED	3.0	23.5	21	100	21.42
FCFGBLN003	FCPG-13.5 BRASS NUT NICKLE PLATED	3.0	25.5	23	100	24.76
FCFGBLN017	FCPG-16 BRASS NUT NICKLE PLATED	3.0	29.0	26	100	32.76
FCFGBLN004	FCPG-21 BRASS NUT NICKLE PLATED	3.5	35.0	32	100	49.33
FCFGBLN005	FCPG-29 BRASS NUT NICKLE PLATED	4.0	45.0	41	100	79.77
FCFGBLN006	FCPG-36 BRASS NUT NICKLE PLATED	5.0	56.0	51	100	123.91
FCFGBLN007	FCPG-42 BRASS NUT NICKLE PLATED	5.0	65.0	60	100	249.75
FCFGBLN008	FCPG-48 BRASS NUT NICKLE PLATED	5.5	69.0	64	100	338.88
FCFGBLN009	FCPG-63 BRASS NUT NICKLE PLATED	5.5	78.0	70	100	446.70

Metric Threads

Part Code	Part Description	Dimensions			Packing Per Carton	MRP Per Pcs
		A	B			
		mm	mm	mm	Pcs	Rs.
FCFGBLN010	FCM12X1.5 BRASS NUT NICKLE PLATED	3.0	16.5	15	100	16.00
FCFGBLN011	FCM16X1.5 BRASS NUT NICKLE PLATED	3.0	20.8	19	100	23.31
FCFGBLN012	FCM20X1.5 BRASS NUT NICKLE PLATED	3.5	26.0	24	100	29.57
FCFGBLN013	FCM25X1.5 BRASS NUT NICKLE PLATED	3.5	33.0	30	100	53.27
FCFGBLN014	FCM32X1.5 BRASS NUT NICKLE PLATED	4.5	40.0	36	100	63.55
FCFGBLN015	FCM40X1.5 BRASS NUT NICKLE PLATED	4.5	51.0	46	100	137.45
FCFGBLN016	FCM50X1.5 BRASS NUT NICKLE PLATED	5.5	60.0	55	100	183.88
FCFGBLN019	FCM63X1.5 BRASS NUT NICKLE PLATED	5.5	60.0	55	100	444.93



Brass Blanking Plugs in Metric & PG Threads

- Raw material : Brass nickle plated
- Colors available : Silver
- Ingress protection : IP - 66 (IP 68 with rubber 'O' ring available at additional cost)

Blanking plugs are used to plug holes where existing threading is provided or for plain holes like in panels. They are used to prevent ingress protection during transportation or use of the apparatus. The blanking plugs are produced to go/ nogo gauges and are hence suitable with any compatible threaded diameters as provided in the table.

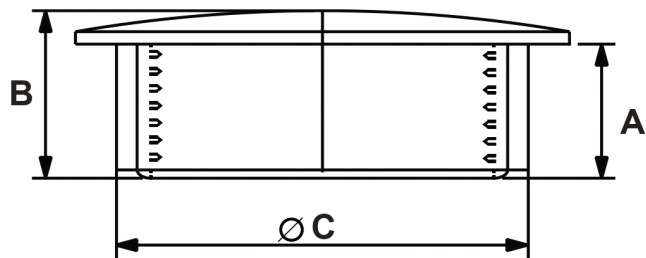

PG Threads

Part Code	Part Description	Threading Type	A	B	Ø C	Packing Per Pkt	MRP Per Pcs
			mm	mm	mm	Pcs	Rs.
FCFGBBP001	FCBP-7 BRASS (BLANKING PLUG)	PG-7	14.0	8.0	12.48	100	125.00
FCFGBBP002	FCBP-9 BRASS (BLANKING PLUG)	PG-9	17.2	8.0	14.85	100	162.00
FCFGBBP003	FCBP-11 BRASS (BLANKING PLUG)	PG-11	21.6	8.0	18.30	100	225.00
FCFGBBP004	FCBP-13.5 BRASS (BLANKING PLUG)	PG-13.5	23.0	8.5	20.00	100	257.50
FCFGBBP005	FCBP-16 BRASS (BLANKING PLUG)	PG-16	25.5	8.5	22.50	100	285.00
FCFGBBP006	FCBP-21 BRASS (BLANKING PLUG)	PG-21	31.3	8.5	28.00	100	440.00
FCFGBBP007	FCBP-29 BRASS (BLANKING PLUG)	PG-29	41.0	9.0	36.70	50	832.50
FCFGBBP008	FCBP-36 BRASS (BLANKING PLUG)	PG-36	51.0	9.0	46.80	25	1210.00
FCFGBBP009	FCBP-42 BRASS (BLANKING PLUG)	PG-42	58.0	10.0	50.00	25	1705.00
FCFGBBP010	FCBP-48 BRASS (BLANKING PLUG)	PG-48	64.0	10.0	60.00	25	2352.00

Metric Threads

FCFGBBP011	FCBP-M12X1.5 BRASS (BLANKING PLUG)	M-12x1.5	14.0	8.0	11.55	100	132.50
FCFGBBP012	FCBP-M16X1.5 BRASS (BLANKING PLUG)	M-16x1.5	18.0	8.0	15.58	100	220.00
FCFGBBP013	FCBP-M20X1.5 BRASS (BLANKING PLUG)	M-20x1.5	22.0	8.0	19.74	100	290.00
FCFGBBP014	FCBP-M32X1.5 BRASS (BLANKING PLUG)	M-25x1.5	27.5	8.0	24.62	100	435.00
FCFGBBP015	FCBP-M25X1.5 BRASS (BLANKING PLUG)	M-32x1.5	35.0	9.0	31.48	50	655.00
FCFGBBP016	FCBP-M40X1.5 BRASS (BLANKING PLUG)	M-40x1.5	43.0	9.0	39.67	25	1170.00
FCFGBBP017	FCBP-M50X1.5 BRASS (BLANKING PLUG)	M-50x1.5	54.0	9.0	49.53	25	2007.50
FCFGBBP018	FCBP-M63X1.5 BRASS (BLANKING PLUG)	M-63x1.5	67.0	10.0	62.20	25	2572.50



O-ring & Flat Washers for Metric & PG Threaded Glands & Blanking Plugs

- Raw material : Anti slip TPR.
 - Colors available : Black Ral 9005
- Orings and flat washers are used for additional IP protection.

An O-ring, also known as a packing or a toric joint, is a mechanical gasket in the shape of a torus. It's a loop of elastomer with a round cross-section, designed to be seated in a groove and compressed during assembly between two or more parts, forming a seal at the interface.



Part Code	Part Description	Size in MM	Packing Per Pkt	MRP Per Pcs.
		IDxODxT	Pcs	Rs.
FCSFGRUB014	FCOR-7 & M12X1.5 RUBBER ORING	10.0X14.0X2.0	100	4.06
FCSFGRUB067	FCOR-9 & M16X1.5 RUBBER ORING	13.6X17.6X2.0	100	4.68
FCSFGRUB015	FCOR-11 RUBBER ORING	17.0X21.0X2.0	100	4.68
FCSFGRUB066	FCOR-13.5 & M20X1.5 RUBBER ORING	18.0X22.0X2.0	100	6.25
FCSFGRUB016	FCOR-16 RUBBER ORING	21.0X25.0X2.0	100	6.25
FCSFGRUB017	FCOR-21 RUBBER ORING	26.0X31.0X2.5	100	8.50
FCSFGRUB018	FCOR-29 & M40X1.5 RUBBER ORING	35.0X40.0X2.5	100	9.37
FCSFGRUB019	FCOR-36 RUBBER ORING	45.0X50.0X2.5	100	12.50
FCSFGRUB020	FCOR-42 RUBBER ORING	51.0X56.0X2.5	100	18.75
FCSFGRUB068	FCOR-48 RUBBER ORING	57.0X62.0X2.5	100	25.00
FCSFGRUB021	FCOR-63 RUBBER ORING	68.0X73.0X2.5	100	37.50
FCSFGRUB022	FCOR-M25X1.5 RUBBER ORING	23.0X27.0X1.5	100	7.81
FCSFGRUB023	FCOR-M32X1.5 RUBBER ORING	30.0X35.0X2.5	100	10.62
FCSFGRUB024	FCOR-M50X1.5 RUBBER ORING	48.0X53.0X2.5	100	12.50
FCSFGRW0069	FCOR-M63X1.5 RUBBER ORING	62.0X64.0X2.5	100	37.50



Flat washers

- Raw material : TPR Anti slip
- Color : Black Ral 9005
- Types : Flat
- IP Protection: IP 68 with suitable glands



Orings and Flat washers are used for additional IP Protection and provide adequate sealing between the glands and the apparatus to protect the equipment from dust and water contamination.

Part Code	Part Description	Size in MM	Packing Per Pkt	MRP Per Pcs.
		IDxODxT	Pcs	Rs.
FCSFGRUB058	FCNW PG-7/M12 & FCQCP-M12 FLAT WASHER	11.5x19.0x2.0	100	2.25
FCSFGRUB037	FCNW PG-9/M16 & FCQCP-16 FLAT WASHER	16.0x26.0x2.0	100	6.25
FCSFGRUB038	FCNW PG-11 FLAT WASHER	18.5x25.6x2.0	100	7.81
FCSFGRUB039	FCNW PG-13.5/M20 & FCQCP-20 FLAT WASHER	21.2x33.8x2.0	100	9.37
FCSFGRUB040	FCNW PG-16 FLAT WASHER	22.0x34.0x2.0	100	9.37
FCSFGRUB041	FCNW PG-21 FLAT WASHER	28.0x41.4x2.0	100	10.93
FCSFGRUB042	FCNW PG-29 FLAT WASHER	36.4x49.4x2.0	100	12.50
FCSFGRUB043	FCNW PG-36 FLAT WASHER	46.4x57.1x2.0	100	14.06
FCSFGRUB044	FCNW PG-48 FLAT WASHER	58x69.8.0x2.0	100	16.62
FCSFGRUB045	FCNW M25X1.5 & FCQCP-25 FLAT WASHER	24.5x41.8x2.0	100	7.81
FCSFGRUB046	FCNW M32 & FCQCP-32 FLAT WASHER	32.0x41.5x2.0	100	9.37
FCSFGRUB047	FCNW M40 & FCQCP-40 FLAT WASHER	40.1x50.0x2.0	100	10.93
FCSFGRUB048	FCNW M50 & FCQCP-50 FLAT WASHER	50.2x58.2x2.0	100	14.06
FCSFGRUB049	FCNW M63 & FCQCP-63 FLAT WASHER	61.0x68.1x2.0	100	15.62