

Energy distribution, Controls & Wiring accessories.



Pricelist (with effect from)
01st May
2026

Let's shape better tomorrows.

At Hager, we believe every building holds untapped potential. Through intelligent electrification, we transform buildings from passive energy consumers into active contributors to a cleaner, smarter world. By enabling each one to produce, store, and manage energy efficiently, we reduce emissions and enhance quality of life within and beyond its walls.



Partnership at every step

No electrification journey is the same. That's why we work hand-in-hand with homeowners, electricians, specifiers, architects, and facility managers. Together we co-create solutions that are safe, intelligent, and tailored to real needs. At Hager, our role goes beyond delivering solutions – we are the expert partner that guides, supports, and unlocks the potential of buildings.



Our energy starts with people

Since 1955, Hager has grown from a family-owned company in Ensheim, Germany, into a global leader with over 13,000 employees and customers in more than 100 countries. What has never changed is our spirit. United by authenticity, integrity, and courage, our people are the energy behind Hager – innovators and pioneers shaping tomorrow's electrical world.



Better buildings. Better tomorrows

This is more than a vision – it's our contribution. By providing electrification solutions to optimise energy use across every building type, we create safer, more sustainable, and enjoyable tomorrows.



Let's build
better buildings
for a better
tomorrow.

We spend over 90% of our lives in buildings.*

From the homes that shelter us to the places where we work, heal, play, and store what matters, most of life happens in buildings.

To support this way of life, buildings provide continuous services: heating, cooling, ventilation, lighting, powering our devices, and even our cars.

All of it runs on electricity.



* Dimitroulopoulou, S., et al. (2023). Indoor Air Quality Guidelines from across the world: An appraisal considering energy saving, health, productivity, and comfort. *Environment International*, 178, 108127.

The background image shows a modern architectural scene. On the left is a building with a glass facade. In the center is a building with a blue, angular roof and light-colored wood paneling. In the foreground, a man and a woman are walking on a paved plaza, pushing a stroller. A small stream or water feature is visible in the lower-left corner. The sky is clear and blue.

Our ambition is clear: We will create better tomorrows through better buildings.

With high-quality, intelligent electrical solutions, and expertise at every step, we help electrify buildings for a more sustainable future.



Leading the next transformation in buildings

We stand at the threshold of the greatest transformation the built environment has ever seen. For Hager, this is not our first. As a trusted partner in electrification for decades, we have navigated change before by adapting, innovating, and helping our partners create safer, more efficient spaces. Now, we are ready to lead again, shaping the future of intelligent, sustainable buildings together.

20 %

of existing buildings need to be renovated to zero-carbon-ready by 2030.*

About

60 %

of buildings that will exist by 2050 haven't been built yet.**

* International Energy Agency. (2022). Renovation of near 20% of existing building stock to zero-carbon-ready by 2030 is ambitious but necessary.

** UN Environment programme. (2023). Global Status Report for Buildings and Construction.



Our goal is better tomorrows.

At Hager, sustainability is built into every decision – from product design to supply chain. In 2025, we earned the EcoVadis Platinum rating, placing us among the top 1% worldwide for ESG performance.

Our solutions are designed for longevity, efficiency, and recyclability, helping customers cut their carbon footprints and extend positive impact beyond our operations.

To us, sustainability also includes creating safe, inclusive workplaces and upholding strong ethical standards. We measure success in emissions reduced, people empowered, and partnerships strengthened.

The Platinum rating is just the start – we're committed to embedding sustainability more deeply and shaping a better future with our customers and partners.

PLATINUM

Top 1%

ecovadis

Sustainability Rating

NOV 2025

Let's accelerate our energy transition towards more renewables, electric mobility and energy management.



Sabine Busse
Hager Group CEO

Dear customers, partners and friends of Hager Group

We are living through a time of change. The new geopolitical and market environment makes us realise even more how precious our resources are and how important energy is to our way of life.

The recent developments call upon us to further accelerate our energy transition. More renewables, more electric mobility, more energy management. More than ever, we understand what "the future will be electric" really means. This necessary change is a possibility for our industry as a whole.

Energy scarcity makes us appreciate energy efficiency and management in a new way. Our industry plays an essential part in providing the products and solutions to master these challenges. We sit at the heart of shaping the electrical world of tomorrow, a world in which long-term success goes hand in hand with sustainable practices. The current challenges make us all the more determined to ignite this change ourselves - together with our partners and customers.

There is a special strength in pulling together, in finding common ground, in talking to each other and understanding what the other party needs most and how we can support each other. Together, we form a strong network, able to master the challenges ahead of us now and in the future. Of this I am convinced.

I remain optimistic. The challenges are immense. But I don't know of any other industry for which this era of change is such a great opportunity. We have it in our hands to prove ourselves and to build a great future for our industry.

Yours sincerely,
Sabine Busse

01 Distribution boards

novello+ range / Metal plug & socket outlet accessory / golf / vector /
Busbars and terminals



14-23

02 aptis +

SPN Distribution Board/ Standard TPN Distribution Board/Vertical
TPN Distribution Board/ Vertical TPN distribution Board- MCCB
Incomer/ Flexi Distribution Board/ Phase segregated Distribution
Board



24-34

03 Protection and switching devices

hws ACBs / **h3** + MCCBs /h3 MCCB / h2 MCCB / Power Contactors /
Relays /Manual Changeover switches / Automatic transfer switches /
ACCL /MCBs / RCCBs / RCBOs / Accessories / HRC Fuses and Fuse
carriers /Surge protection devices / Isolating switches / Changeover
switches / Multifunction Meter / Voltage Relay & Timer



35-72

04 Energy and lighting control

Indicator lights / Modular contactors / Movement & presence
detectors / multi function meter



74-75

05 insysta™ Wiring Accessories

Switches / Push button / Sockets / Regulators & dimmers / Data sockets /
VDI module & accessories / USB socket / / Volume controller /
Cover & grid plates - Plastic / Cover plates - Real material /
Grid plates - Real material / Wall Boxes



76-80

From inception to completion, customized or simple your modern building designs gets delivered with Hager distribution boards.
#bringinglifetobuildings

Distribution Board

novello+

tried and tested



Type-tested performance to IEC-61439-1 IS 8623-III



Unique ease of mounting with minimal screws



Trusted rigidity and extra durability (IP43, IK09)



Tried flexibility thanks to modular design



novello ⁺ SPN	14
novello ⁺ TPN	15
novello ⁺ vertical TPN modular incomer	16
novello ⁺ TPN phase segregated	17
novello ⁺ vertical TPN MCCB incomer	18
novello ⁺ one way enclosures	19
novello ⁺ plug & socket outlets - metal	20
golf enclosures	21
vector enclosures	22



VYS12C

SPN distribution boards

Characteristics:

- Single Door: IP30
- Double Door: IP43 & IP54
- Plain & Acrylic doors
- As per IS 8623 - III
- Impact resistance IK09

- Accessories:
- Wires sets
- Insulated busbars
- Insulated IP2X neutral bars & earth bar
- Blanking plates
- Cable management kit
- Circuit identification labels as standard

IP30 Single Door DBs

Description	Pack Qty.	Cat. Ref.	Unit MRP (₹)
6 way, 6 modules	1	VYS06C	2038
8 way, 8 modules	1	VYS08C	2565
12 way, 12 modules	1	VYS12C	3035
16 way, 16 modules	1	VYS16C	3741
18 way, 18 modules	1	VYS18C	4290



VYS12D

IP43 Double Door DBs

Description	Pack Qty.	Cat. Ref. plain door	Unit MRP (₹)
4 way, 4 modules	1	VYS04D	2699
6 way, 6 modules	1	VYS06D	3035
8 way, 8 modules	1	VYS08D	3360
12 way, 12 modules	1	VYS12D	4032
16 way, 16 modules	1	VYS16D	5130
18 way, 18 modules	1	VYS18D	5622

- IP54 DB's available upon request
- Glazed door DB's available upon request
- Pre-wired and TV telephone DBs available on request.
- For price and technical information, please contact your nearest Hager sales office.



VYT06CH

TPN distribution boards

Characteristics:

- Single Door: IP30
- Double Door: IP43 & IP54
- Plain & Acrylic doors
- As per IS 8623 - III
- Impact resistance IK09
- 8 module Incomer & SP MCBs as O/G

Accessories:

- Wires sets
- Insulated busbars
- Insulated IP2X neutral bars & earth bar
- Blanking plates
- Cable management kit
- Circuit identification labels as standard

IP30 Single Door DBs
(Incomer + Outgoing Modules)

Description	Pack Qty.	Cat. Ref.	Unit MRP (₹)
4 way, 4+12 modules	1	VYT04CD	5253
6 way, 4+18 modules	1	VYT06CD	6362
4 way, 8+12 modules	1	VYT04CH	5757
6 way, 8+18 modules	1	VYT06CH	7090
8 way, 8+24 modules	1	VYT08CH	8333
12 way, 8+36 modules	1	VYT12CH	12354



VYT06DH

IP43 Double Door DBs
(Incomer + Outgoing Modules)

Description	Pack Qty.	Cat. Ref. metal door	Unit MRP (₹)
4 way, 4+12 modules	1	VYT04DD	6373
6 way, 4+18 modules	1	VYT06DD	7661
4 way, 8+12 modules	1	VYT04DH	6642
6 way, 8+18 modules	1	VYT06DH	8187
8 way, 8+24 modules	1	VYT08DH	9834
12 way, 8+36 modules	1	VYT12DH	14706
16 way, 8+48 modules	1	VYT16DH	18234

Novello+ Distribution Boards



Advantages for you:

- Professional alignment with spirit level
- Reusable & flexible cable management
- Better protection with unique door packaging
- Upgrade to lockable enclosures possible

Standard Accessories:

- Wires sets
- Insulated bus bars
- Insulated neutral bars & earth bar
- blanking plates, Cable management system
- Circuit identification labels

- IP54 DB's available upon request
- Glazed door DB's available upon request
- Pre-wired and TV telephone DBs available on request.
- For price and technical information, please contact your nearest Hager sales office.



VYH04DH

TPN horizontal PPI distribution boards

Characteristics:

- Double Door: IP43 & IP54
- Plain & Acrylic doors
- As per IS 8623 - III
- Impact resistance IK09
- 8 module incomers, 2 module subincomer & SP MCBs as O/G

Accessories:

- Wires sets
- Insulated busbars
- Insulated IP2X neutral bars & earth bar
- Blanking plates
- Cable management kit
- Circuit identification labels as standard

IP43 Double Door DBs
(Incomer+ Sub Incomer + Outgoing Modules)

Description	Pack Qty.	Cat. Ref. plain door	Unit MRP (₹)
4+2 way, 8+6+12 modules	1	VYH04DH	12544
6+2 way, 8+6+18 modules	1	VYH06DH	14784
8+2 way, 8+6+24 modules	1	VYH08DH	20384
12+2 way, 8+6+36 modules	1	VYH12DH	24472

TPN tier PPI distribution board

Characteristics:

- Double Door: IP43 & IP54
- Plain & Acrylic doors
- As per IS 8623 - III
- Impact resistance IK09
- 8 module incomers, 2 module subincomer & SP MCBs as O/G

Accessories:

- Wires sets
- Insulated busbars
- Insulated IP2X neutral bars & earth bar
- Blanking plates
- Cable management kit
- Circuit identification labels as standard



VYP10DH

IP43 Double Door DBs
(Incomer+ Sub Incomer + Outgoing Modules)

Description	Pack Qty.	Cat. Ref. plain door	Unit MRP (₹)
6+2 way, 8+6+18 modules	1	VYP06DH	14739
8+2 way, 8+6+24 modules	1	VYP08DH	17382
10+2 way, 8+6+30 modules	1	VYP10DH	18558
12+2 way, 8+6+36 modules	1	VYP12DH	19544
16+2 way, 8+6+48 modules	1	VYP16DH	21235
12+2 way, MCCB*+ 6 + 36 modules	1	VYP12DM	20339

- *Provision to mount frame X160 h3 MCCB
- For P160 h3+ MCCB mounting, please contact your nearest Hager sales office.

- Acrylic door and IP54 DB's, available upon request.
- For price and technical information, please contact your nearest Hager sales office.

Novello+ Distribution Boards

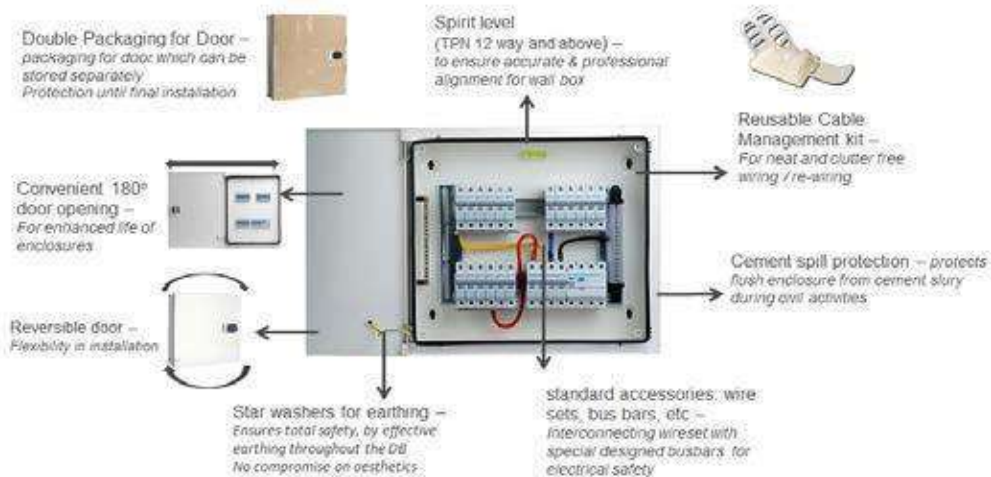



VYV04DL-P

vertical TPN distribution boards (modular incomer)

Characteristics:

- Single Door: IP30
- Double Door: IP43 & IP54
- Plain & Acrylic doors
- As per IS 8623 - III
- Impact resistance IK09
- 12 module incomers, SP/TP MCB's outgoing

Accessories:

- Interconnection labels
- Blanking plates
- Cable management kit

**IP43 Double Door DBs
(Incomer + Outgoing Modules)**

Description	Pack Qty.	Cat. Ref.	Unit MRP (₹)
4 way, 12+12 modules	1	▶ VYV04DL-P	16940
6 way, 12+18 modules	1	▶ VYV06DL-P	18941
8 way, 12+24 modules	1	▶ VYV08DL-P	20792
12 way, 12+36 modules	1	▶ VYV12DL-P	29268
16 way, 12+48 modules	1	VYV16DL-P	37237

- Acrylic door and IP54 DB's, available upon request.
- For price and technical information, please contact your nearest Hager sales office.

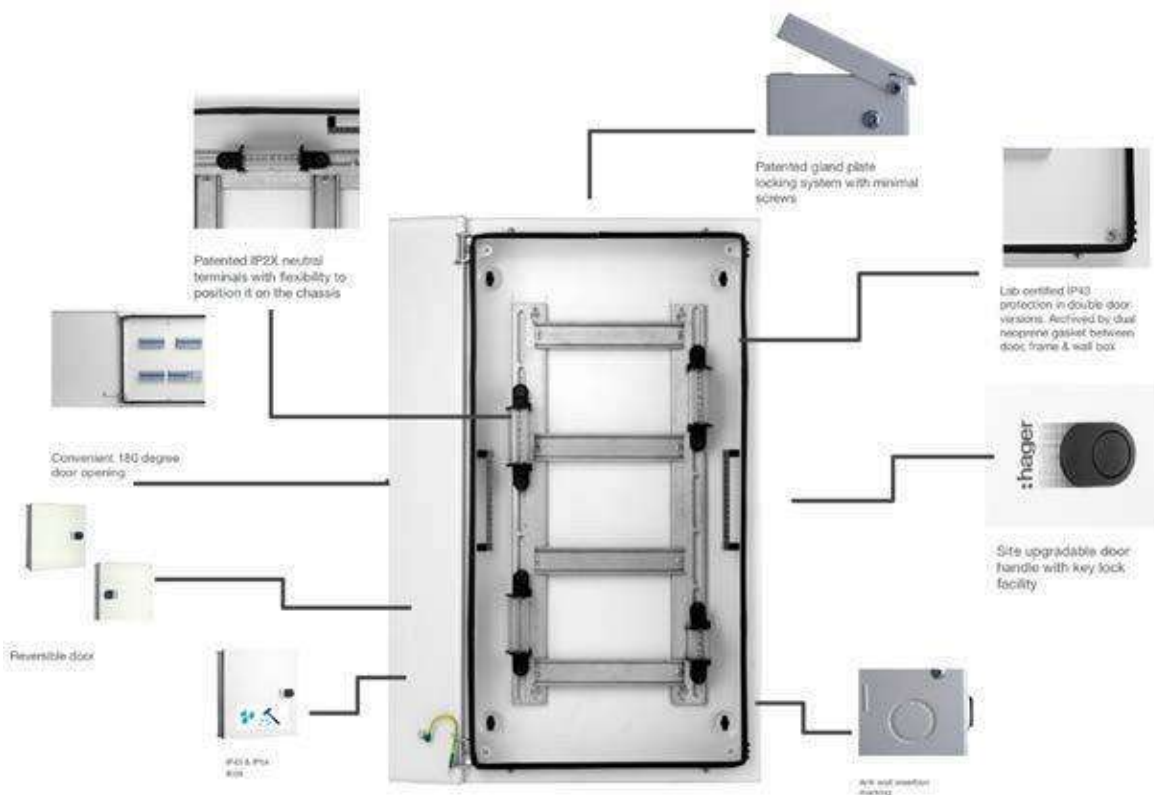



VYV06DM-P

vertical TPN distribution boards (x160 h3 MCCB incomer)

Characteristics:

- Double Door: IP43
- As per IS 8623 - III
- Impact resistance IK09
- X160 frame h3 MCCB incomer & SP/TP MCBs as outgoing
- Accessories:
 - 160A rated busbar
 - Blanking plates
 - Cable management kit
 - Identification labels as standard

**IP43 Double Door DBs
(MCCB + Outgoing Modules)**

Description	Pack Qty.	Cat. Ref.	Unit MRP (₹)
4 way, MCCB+12 modules	1	▶ VYV04DM-P	20976
6 way, MCCB+18 modules	1	▶ VYV06DM-P	23828
8 way, MCCB+24 modules	1	▶ VYV08DM-P	26232
12 way, MCCB+36 modules	1	▶ VYV12DM-P	35087
16 way, MCCB+48 modules	1	VYV16DM-P	41642



VYV06DM-P160

vertical TPN distribution boards (P160 h3+ MCCB incomer)

Characteristics:

- Double Door: IP43
- As per IS 8623 - III
- Impact resistance IK09
- P160 frame h3 MCCB incomer & SP/TP MCBs as outgoing
- Accessories:
 - 160A rated busbar
 - Blanking plates
 - Cable management kit
 - Identification labels as standard

**IP43 Double Door DBs
(MCCB + Outgoing Modules)**

Description	Pack Qty.	Cat. Ref.	Unit MRP (₹)
4 way, MCCB+12 modules	1	VYV04DM-P160	21586
6 way, MCCB+18 modules	1	VYV06DM-P160	24530
8 way, MCCB+24 modules	1	VYV08DM-P160	27002
12 way, MCCB+36 modules	1	VYV12DM-P160	36099
16 way, MCCB+48 modules	1	VYV16DM-P160	41642



VYV06DM2-P

vertical TPN distribution boards (x250 h3 / P250 h3+ MCCB incomer)

Characteristics:

- Double Door: IP43
- As per IS 8623 - III
- Impact resistance IK09
- x250 h3 / P250 h3+ frame h3 MCCB incomer & SP/TP MCBs as outgoing
- Accessories:
 - 250A rated busbar
 - Blanking plates
 - Cable management kit
 - Identification labels as standard

**IP43 Double Door DBs
(MCCB + Outgoing Modules)**

Description	Pack Qty.	Cat. Ref.	Unit MRP (₹)
4 way, MCCB+12 modules	1	VYV04DM2-P	40055
6 way, MCCB+18 modules	1	VYV06DM2-P	43689
8 way, MCCB+24 modules	1	VYV08DM2-P	46725
12 way, MCCB+36 modules	1	VYV12DM2-P	47990
16 way, MCCB+48 modules	1	VYV16DM2-P	55614



VYG08DL

TPN phase segregated distribution boards
Characteristics:

- Single Door: IP30
- Double Door: IP43
- As per IS 8623 - III
- Impact resistance IK09
- Provision for mounting upto 12 module incomer, 4 module sub-incomer in each phase & SP
- MCBs as outgoing

- Accessories:
- Insulated busbar
- Wire sets
- Insulated IP2X neutral bars & earth bar
- Blanking plates
- Cable management kit
- Identification labels as standard

IP43 Double Door DBs

(Incomer+ Sub Incomer + Outgoing Modules)

Description	Pack Qty.	Cat. Ref. modular incomer	Unit MRP (₹)	Cat. Ref. MCCB incomer*	Unit MRP (₹)
4 way, 12+12+12 modules	1	VYG04DL	16666	VYG04DM	24483
6 way, 12+12+18 modules	1	VYG06DL	18760	VYG06DM	27978
8 way, 12+12+24 modules	1	VYG08DL	20944	VYG08DM	32043
12 way, 12+12+36 modules	1	VYG12DL	26051	VYG12DM	36546

- *Provision to mount X160 frame H3 MCCB



VYC06DH

TPN phase selector distribution boards
Characteristics:

- Single Door: IP30
- Double Door: IP43
- As per IS 8623 - III
- Impact resistance IK09
- 63A rotary switches

- Accessories:
- Wire sets
- Insulated busbars, neutral bars & earth bars
- blanking plates
- Cable management kit
- Identification labels as standard

IP43 Double Door DBs

(Incomer+ Outgoing Modules)

Description	Pack Qty.	Cat. Ref.	Unit MRP (₹)
4 way, 8+12 modules	1	VYC04DH	23374
6 way, 8+18 modules	1	VYC06DH	23374
8 way, 8+24 modules	1	VYC08DH	23374
12 way, 8+36 modules	1	VYC12DH	28638

flexi distribution boards
Characteristics:

- Double Door: IP43 & IP54
- Plain & Acrylic doors
- As per IS 8623 - III
- Impact resistance IK09
- Flexibility to mount incomer & outgoing as per need

- Accessories:
- Blanking plates
- Insulated IP2X neutral bars & earth bar
- Circuit identification labels as standard

IP43 Double Door DBs

(Total Modules)

Description	Pack Qty.	Cat. Ref.	Unit MRP (₹)
2 row, 28 modules	1	VYF214D	9162
3 row, 42 modules	1	VYF314D	11323
4 row, 40 modules	1	VYF410D	11144
4 row, 56 modules	1	VYF414D	11984
4 row, 64 modules	1	VYF416D	14134

- Acrylic door and IP54 DB's, available upon request.
- For price and technical information, please contact your nearest Hager sales office.



VYF414D



VYM04C

one way enclosures

Characteristics:

- IP30 degree of protection

Description	Pack Qty.	Cat. Ref.	Unit MRP (₹)
2 way, 2 modules	1	VYM02C	1109
4 way, 4 modules	1	VYM04C	1109
6 way, 6 modules	1	VYM06C	1915
8 way, 8 modules	1	VYM08C	1915
metal enclosure hinged door, 3 pole, x160 frame MCCB	1	VYM160HM	4245
metal enclosure hinged door, 4 pole, x160 frame MCCB	1	VYM161HM	4245
metal enclosure hinged door, 3 pole, x250 frame MCCB	1	VYM250HM	11077
metal enclosure hinged door, 4 pole, x250 frame MCCB	1	VYM251HM	11077
160A 3P MCCB h3+ Enclosure	1	VYM160HM-P160	4480
160A 4P MCCB h3+ Enclosure	1	VYM161HM-P160	4480
250A 3P MCCB h3+ Enclosure	1	VYM250HM-P250	11704
250A 4P MCCB h3+ Enclosure	1	VYM251HM-P250	11704
630A 3P MCCB h3+ Enclosure	1	VYM630HM-P630	12656
630A 4P MCCB h3+ Enclosure	1	VYM631HM-P630	12656



VYA220C

plug & socket outlets - metal

Characteristics:

- Supplied with metal plug & socket
- Provision to mount MCBs

- Metal plug & socket: IP30

Description	Pack Qty.	Cat. Ref.	Unit MRP (₹)
10A 2 Pin + SC*, 1 modules	1	VYA110C	2509
20A 2 Pin + SC*, 1 modules	1	VYA120C	2610
20A 2 Pin + SC*, 2 modules	1	VYA220C	2845
20A 3 Pin + SC*, 4 modules	1	VYA420C	4379
32A 3 Pin + SC*, 4 modules	1	VYA432C	5734
63A 5 Pin + SC*, 8 modules	1	VYA863C	19835

* SC - Scraping Earth



VYB432C

plug & socket outlets - plastic

Characteristics:

- Plastic plug & socket:IP54
- Provision to mount MCBs

- Accessories:
- Plastic plug & socket

Description	Pack Qty.	Cat. Ref.	Unit MRP (₹)
16A 3 Pin, 4 modules	1	VYB416C	4077
32A 3 Pin, 4 modules	1	VYB432C	4402
32A 5 Pin, 8 modules	1	VYB832C	8008
63A 5 Pin, 8 modules	1	VYB863C	20160



VZ130I & VZ140I

plug & socket outlets
Characteristics:

- Metal plug & socket: IP44

Description	Pack Qty.	Cat. Ref.	Unit MRP (₹)	Description	Cat. Ref.	Unit MRP (₹)
10A 2P+E Metal Plug	10	VZ130I	339	10A 2P+E Metal Socket	VZ140I	350
20A 2P+E Metal Plug	10	VZ131I	350	20A 2P+E Metal Socket	VZ141I	382
20A 3P+E Metal Plug	10	VZ132I	477	20A 3P+E Metal Socket	VZ142I	519
32A 3P+E Metal Plug	5	VZ133I	848	32A 3P+E Metal Socket	VZ143I	848
63A 5P Metal Plug	1	VZ134I	3869	63A 5P Metal Socket	VZ144I	4102

cable end box for novello⁺ DBs
Characteristics:

- Matt finish
- Powder coated with RAL 9010
- Cable end box suitable for double door DBs.
- Facilitates wiring & wire dressing
- Mounted on top of double door DBs

Description

VYT08E

CEB for SPN DBs	Pack Qty.	Cat. Ref.	Unit MRP (₹)
CEB for 4 way SPN DD DB	1	VYS04E	1232
CEB for 6 way SPN DD DB	1	VYS06E	1299
CEB for 8 way SPN DD DB	1	VYS08E	1445
CEB for 12 way SPN DD DB	1	VYS12E	1635
CEB for 16 way SPN DD DB	1	VYS16E	2307
CEB for 18 way SPN DD DB	1	VYS18E	2397

CEB for TPN DB (for 8mod incomer)

CEB for 4 way TPN DD DB	1	VYT04E	2117
CEB for 6 way TPN DD DB	1	VYT06E	2285
CEB for 8 way TPN DD DB	1	VYT08E	4021
CEB for 12 way TPN DD DB	1	VYT12E	5376
CEB for 16 way TPN DD DB	1	VYT16E	5376

CEB for TPN Horizontal PPI DB

CEB for 2 + 4 way Horizontal PPI DD DB	1	VYH04E	2218
CEB for 2 + 6 way Horizontal PPI DD DB	1	VYH06E	3483
CEB for 2 + 8 way Horizontal PPI DD DB	1	VYH08E	4077
CEB for 2 + 12 way Horizontal PPI DD DB	1	VYH12E	4603

CEB for TPNTier PPI DB

CEB for 2 + 6 way Tier PPI DD DB	1	VYP06E	1915
CEB for 2 + 8 way Tier PPI DD DB	1	VYP08E	1949
CEB for 2 + 10 way Tier PPI DD DB	1	VYP10E	2419
CEB for 2 + 12 way Tier PPI DD DB	1	VYP12E	3696
CEB for 2 + 12 way Tier PPI DD DB (MCCB)	1	VYP12EM	3864

CEB for vertical TPN DB

CEB for Vertical TPN DD DB	1	VYV00E	6072
----------------------------	---	---------------	------

CEB for Flexi DB

CEB for 14Mod flexy DB	1	VYF14E	2016
CEB for 16Mod flexy DB	1	VYF16E	2453

CEB for PSG DB

CEB for 4 way PSG DB	1	VYG04E	2822
CEB for 6 way PSG DB	1	VYG06E	3170
CEB for 8 way PSG DB	1	VYG08E	3517
CEB for 12 way PSG DB	1	VYG12E	5062

Note: DD means double door

Accessories for novello⁺ DBs

Description	Pack Qty.	Cat. Ref.	Unit MRP (₹)
Keylock + 2 keys	10	VZ100i	2473
Door handle for novello ⁺ TPN DB	10	VZ101i	1081
Neutral link 5 connection	10	VZ110i	276
Neutral link 9 connection	10	VZ111i	380
Neutral link 15 connection	10	VZ112i	518
Neutral link 19 connection	10	VZ113i	587
4 way 8 Segment cover plate - 4 Mod	5	VZ120i	587
8 way 8 Segment cover plate - 4 Mod	5	VZ121i	713
6 way 8 Segment cover plate - 4 Mod	5	VZ122i	840



VZ100i



VF312TJ

golf enclosures

Characteristics:

- Double door: IP40
- Flush & surface mounted versions

- Plain & transparent door versions system
- Easy and safe cable management

Flush mounting

Description	Pack Qty.	Cat. Ref. plain door	Cat. Ref. acrylic door	Unit MRP (₹)
1 row 8 modules (8 way SPN DB)	1	VF108PJ	VF108TJ	3257
1 row 12 modules (12 way SPN DB)	1	VF112PJ	VF112TJ	4130
1 row 18 modules (18 way SPN DB)	1	VF118PJ	VF118TJ	5239
2 row 24 modules (6 way TPN DB)	1	VF212PJ	VF212TJ	6325
2 row 36modules (8 way TPN DB)	1	VF218PJ	VF218TJ	6549
3 row 36 modules (8 way TPN DB)	1	VF312PJ	VF312TJ	8260
4 row 48 modules (12 way TPN DB)	1	VF412PJ	VF412TJ	10113



VS412PJ

Surface mounting

Description	Pack Qty.	Cat. Ref. plain door	Cat. Ref. acrylic door	Unit MRP (₹)
1 row 8 modules (8 way SPN DB)	1	VS108PJ	VS108TJ	3257
1 row 12 modules (12 way SPN DB)	1	VS112PJ	VS112TJ	4130
1 row 18 modules (18 way SPN DB)	1	VS118PJ	VS118TJ	5511
2 row 24 modules (6 way TPN DB)	1	VS212PJ	VS212TJ	6325
2 row 36modules (8 way TPN DB)	1	VS218PJ	VS218TJ	8590
3 row 36 modules (8 way TPN DB)	1	VS312PJ	VS312TJ	8260
4 row 48 modules (12 way TPN DB)	1	VS412PJ	VS412TJ	10113

**golf
enclosures**



Advantages for you:

- Easy mounting - wall box can be turned 180° and has a removable cable entry slide
- More wiring space - between the modular devices and terminals as well as behind the DIN rails
- Clean and convenient wiring - thanks to patented integrated cable management system
- Unbreakable door hinges
- Same door for VS surface mounted version and VF flush mounted version
- Optimised conduit and trunking entries



VE318L

vector enclosures

Characteristics:

- Double door: IP65
- Surface mounted version

- Flexibility to mount incomer & outgoing as per need

Total modules

Description	Pack Qty.	Cat. Ref.	Unit MRP (₹)
1 row 3 modules	1	VE103L	3800
1 row 6 modules	1	VE106L	4720
1 row 10 modules	1	VE110L	6573
1 row 12 modules	1	VE112L	7800
1 row 18 modules	1	VE118L	9287
2 row 24 modules	1	VE212L	10573
2 row 36 modules	1	VE218L	15647
3 row 36 modules	1	VE312L	14325
4 row 48 modules	1	VE412L	20308
3 row 54 modules	1	VE318L	23175
vector IP65 Key lock	1	VZ311	1116

Busbars, neutral bars & other accessories for DBs

Characteristics:

- All Insulated busbars are rated for 63A



KDN163A

Fork busbars (for MCBs NBN---N, NCN---N & NDN---N)

Description	Pack Qty.	Cat. Ref.	Unit MRP (₹)
1 pole 1 mod step, 12 mod	100	KDN163A	637
1 pole 1 mod step, 56 mod	50	KD163B	2311
2 pole 2 mod step, 12 mod	50	KDN263A	1080
2 pole 2 mod step, 56 mod	20	KD263B	4568
3 pole 3 mod step, 12 mod	50	KDN363A	1145
3 pole 3 mod step, 57 mod	20	KD363B	5584
4 pole 4 mod step, 12 mod	25	KDN463A	2376
4 pole 4 mod step, 56 mod	10	KD463B	10260

Prong busbars (for MCBs ML---J)

Description	Pack Qty.	Cat. Ref.	Unit MRP (₹)
1 pole 1 step 13 mod - Brown (phase)	1	KB163P	659
1 pole 1 step 13 mod - Blue (neutral)	1	KB163N	659

End caps for busbars

Description	Pack Qty.	Cat. Ref.	Unit MRP (₹)
for 1 pole fork busbar	50	KZN021	46
for 2 & 3 pole fork busbar	10	KZN023	58
for 4 pole fork busbar	10	KZN024	104

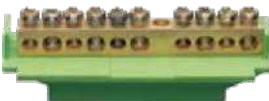

KM14N

Description	Pack Qty.	Cat. Ref.	Unit MRP (₹)
One mod blanking plate	50	P032F	46

new aptis+



**Spacious
and smart**

:hager

SPN Distribution Board	29
TPN Distribution Board	30
Vertical TPN Distribution Board	31
Vertical TPN distribution Board- MCCB Incomer	32
Flexi Distribution Board	33
Phase segregated Distribution Board	34

aptis+ Distribution Boards: Looks, features, technology- a perfect blend

Innovation is the key driver in our business, bringing clear differentiation in our products. Our solutions exceed the expectations of our customers given the product's ease-of-installation & ease-of-use.



**The new aptis+ enclosure
is primarily designed for
residential applications.**

aptis+, totally redesigned



A sophisticated design

The rounded door edge are just some of the signature features that make the new aptis+ enclosures so distinctive.



aptis+ your enclosure

We collaborated closely with end users to bring you this new version.

aptis+, a hub of innovation

Discover...

- 01** Quick, easy installation
- 02** Unrivalled accessibility
- 03** Easy wiring: tidier and safer
- 04** More features to make your day-to-day work easier
- 05** Reliable and safe: compliant standard IS/IEC 61439
- 06** RAL9016, powder coated
Door opening angle -180°
Impact resistance – IK09

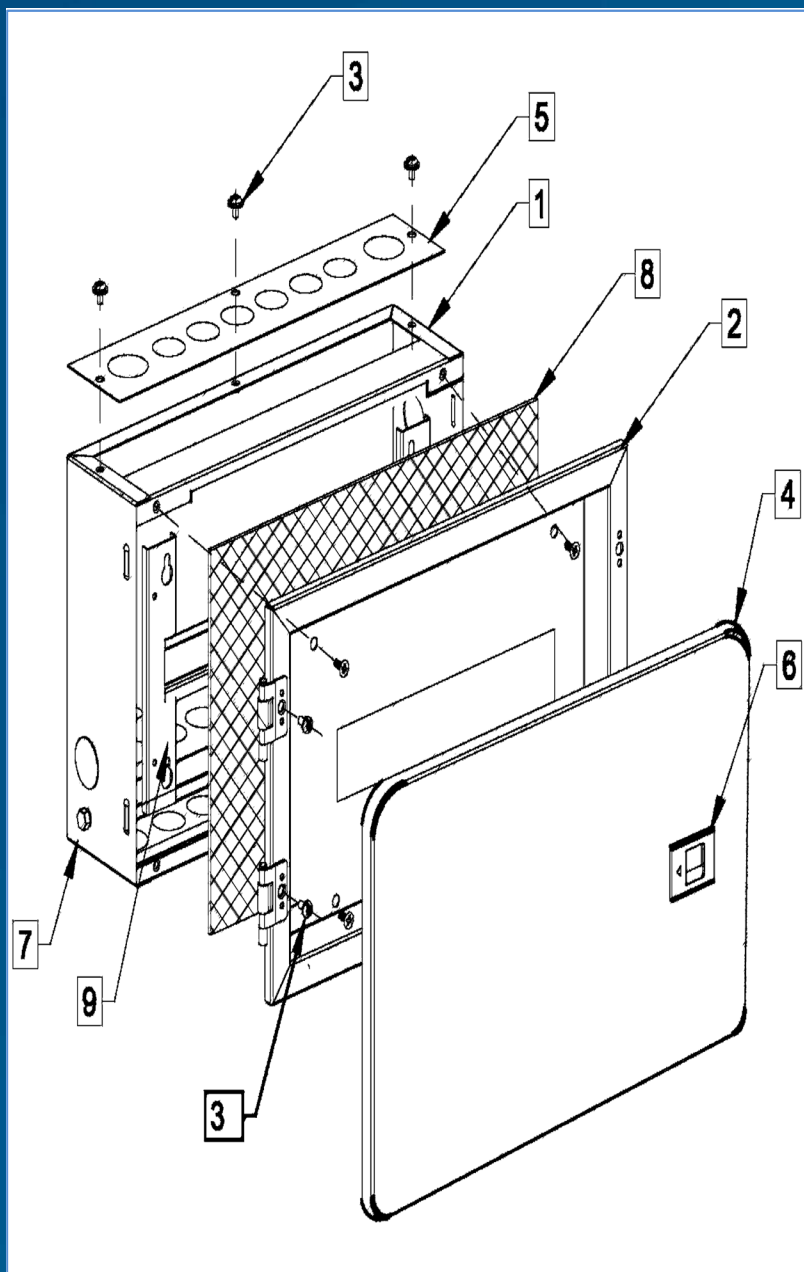

SPN

- Metal DBs for single phase & neutral (SPN) supply distribution

Technical data

- Conforms to IS/IEC 61439
- No. of modules – 4, 6, 8, 12, 16, 18 way
- Mounting – Surface / flush mounting
- IP43 for double door
- Material – CRCA sheet steel
- RAL9016

Incoming & outgoing devices

- Incoming : Two pole MCBs / RCBOs / RCCB / Isolator
- Outgoing : SP MCBs as per way

Features & benefits:

- Reversible door with 180 degree opening
- IP2X Neutral terminal
- Cement spill protection
- Anti wall insertion marking
- 100A tin plated insulated copper bus-bar
- Detachable Gland plate at Top & Bottom



Description	Pack Qty.	Cat. Ref.	MRP (₹)
4 way, 4 modules	1	VYS04DN	2162
5 way, 6 modules	1	VYS06DN	2498
8 way, 8 modules	1	VYS08DN	2699

One Way Enclosures

-Metal enclosures for flush and surface mounting

Technical data

- Conforms to IS/IEC 61439
- No. of modules – 2, 4, 6 & 8 modules
- Mounting – surface / flush mounting
- IP category – IP30 for single door
- Material – CRCA sheet steel
- Color – RAL 9016, matt finish

Features & benefits:

- Compact in size



VYM04CN

Description	Pack Qty.	Cat. Ref.	MRP (₹)
2 way, 2 modules	1	VYM02CN	795
4 way, 4 modules	1	VYM04CN	795
6 way, 6 modules	1	VYM06CN	1299
8 way, 8 modules	1	VYM08CN	1299

TPN Distribution Board Technical Data

- Conforms to IS/IEC 61439
- No. of modules – 4, 6, 8, 12, 16 way
- Mounting – Surface / flush mounting
- IP category
- IP43 for double door
- Material – CRCA sheet steel

-RAL 9016

Features & benefits:

- Reversible door with 180 degree opening
- IP2X Neutral terminal
- Cement spill protection
- Anti wall insertion marking
- 100A tin plated insulated copper bus-bar
- Detachable Gland plate at Top & Bottom

Incoming & outgoing devices

- Incoming : Four pole MCBs / RCBOs / RCCB / Isolator
- Outgoing : SP MCBs as per way up to 63A

Description	Pack Qty.	Cat. Ref.	Unit MRP (₹)
4 way, 8+12 modules	1	VYT04DHN	5309
6 way, 8+18 modules	1	VYT06DHN	6608
8 way, 8+24 modules	1	VYT08DHN	7930
12 way, 8+36 modules	1	VYT12DHN	12208
16 way, 8+48 modules	1	VYT16DHN	15310



PPI CONVERSION KIT

Description	Pack Qty.	Cat. Ref.	Unit MRP (₹)
For 4 way TPN DB	1	VYW04EN	3763
for 6 way TPN DB	1	VYW06EN	4245
for 8 way TPN DB	1	VYW08EN	4861
for 12 way TPN DB	1	VYW12EN	5466
for 16 way TPN DB	1	VYW16EN	6082

Vertical TPN Distribution Board – Modular incomer

Technical data

- Conforms to IS/IEC 61439
- No. of modules – 4, 6, 8, 12, 16 way
- Mounting – Surface / flush mounting -- IP43 for double door
- Material – CRCA sheet steel
- RAL 9016

Incoming & outgoing devices

- Incoming : I/C 8 module, MCB, RCCB, RCBO
- Outgoing : SP / TP MCB

Features & benefits:

- Reversible door with 180 degree opening
- IP2X Neutral terminal
- Cement spill protection
- Anti wall insertion marking
- Accessory kit
- Detachable Gland plate at Top & Bottom
- 200A copper bus bar

Description	Pack Qty.	Cat. Ref.	Unit MRP (₹)
4 way, 8+12 modules	1	VYV04DLN	13432
6 way, 8+18 modules	1	VYV06DLN	15100
8 way, 8+24 modules	1	VYV08DLN	17515
12 way, 8+36 modules	1	VYV12DLN	23748
16 way, 8+48 modules	1	VYV16DLN	27278

Vertical TPN Distribution Board – MCCB incomer (*h3 x160 frame 3P/ 4P MCCB)

Technical data

- Conforms to IIS/IEC 61439
- No. of modules – 4, 6, 8, 12, 16 way
- Mounting – Surface / flush mounting -- IP43 for double door
- Material – CRCA sheet steel
- RAL 9016

Features & benefits:

- Reversible door with 180 degree opening
- IP2X Neutral terminal
- Cement spill protection
- Anti wall insertion marking
- Accessory kit
- Detachable Gland plate at Top & Bottom
- 200A Copper bus

Incoming & outgoing devices

- Incoming : I/C 3P/4P MCCB (X160 MCCB) PROVISION-1NO
- Outgoing : SP / TP MCB

Description	Pack Qty.	Cat. Ref.	Unit MRP (₹)
4 way, MCCB+12 modules	1	VYV04DMN	16537
6 way, MCCB+18 modules	1	VYV06DMN	18331
8 way, MCCB+24 modules	1	VYV08DMN	20896
12 way, MCCB+36 modules	1	VYV12DMN	27416
16 way, MCCB+48 modules	1	VYV16DMN	31407

Flexi Distribution Board

Technical data

- Conforms to IS/IEC 61439
- Available in 28, 42, 40, 56 and 64 modules
- Mounting – Surface / flush mounting
- IP43 for double door
- Material - CRCA sheet steel

- RAL 9016

Incoming & outgoing devices

Flexibility to mount incomer and outgoing as per need

Features & benefits:

- Reversible door with 180 degree opening
- IP2X Neutral terminal
- Cement spill protection
- Anti wall insertion marking
- Accessory kit
- Detachable Gland plate at Top & Bottom

Description	Pack Qty.	Cat. Ref.	Unit MRP (₹)
2 row, 28 modules	1	VYF214DN	6854
3 row, 42 modules	1	VYF314DN	8210
4 row, 40 modules	1	VYF410DN	8926
4 row, 56 modules	1	VYF414DN	9598
4 row, 64 modules	1	VYF416DN	11323



Phase Segregated Distribution Board

Technical data

- Conforms to IS/IEC 61439
- No of modules – 4, 6, 8, 12 modules
- Mounting – Surface / flush mounting
- IP43 for double door
- Material - CRCA sheet steel
- RAL 9016

Features & benefits:

- Reversible door with 180 degree opening
- IP2X Neutral terminal
- Cement spill protection
- Anti wall insertion marking
- Accessory kit
- Detachable Gland plate at Top & Bottom

Incoming & outgoing devices

- Incoming : I/C 8 module, MCB, RCCB, RCBO- 1no
- Sub Incoming: 4 Module, RCCB, RCBO- 3no per phase
- Outgoing : O/G SP MCBs

Description	Pack Qty.	Cat. Ref.	Unit MRP (₹)
4 way, 8+12+12 modules	1	VYG04DLN	14190
6 way, 8+12+18 modules	1	VYG06DLN	15994
8 way, 8+12+24 modules	1	VYG08DLN	17842
12 way, 8+12+36 modules	1	VYG12DLN	22142



Accessories

Description	Pack Qty.	Cat. Ref.	Unit MRP (₹)
Cable end box, VTPN, DD	1	VYV00EN	4451
Cable end box, TPN, 4 way, DD	1	VYT04EN	1546
Cable end box, TPN, 6 way, DD	1	VYT06EN	1680
Cable end box, TPN, 8 way, DD	1	VYT08EN	2946
Cable end box, TPN, 12 way, DD	1	VYT12EN	3942
Cable end box, TPN, 16 way, DD	1	VYT16EN	3942
Cable end box, SPN, 4 way, DD	1	VYS04EN	907
Cable end box, SPN, 6 way, DD	1	VYS06EN	952
Cable end box, SPN, 8 way, DD	1	VYS08EN	1053
Cable end box, SPN, 12 way, DD	1	VYS12EN	1198
Cable end box, SPN, 16 way, DD	1	VYS16EN	1691
Cable end box, SPN, 18 way, DD	1	VYS18EN	1758
Cable end box, PSG DB, 4way, DD	1	VYG04EN	2072
Cable end box, PSG DB 6way, DD	1	VYG06EN	2318
Cable end box, PSG DB, 8way, DD	1	VYG08EN	2576
Cable end box, PSG DB, 12way, DD	1	VYG12EN	3707
Cable end box, flexy DB, 4 Row 14M	1	VYF14EN	1478
Cable end box, flexy DB, 4 Row 16M	1	VYF16EN	1803

Protection Devices

Hager protection devices set the industry standard for reliability, quality and performance. It is the mission of company to provide the highest quality products that clearly set themselves apart from the market. Hager range of modular protection devices comprises of over-current protection, residual current protection, surge protection, over-voltage and under-voltage protection solution.



HWS ACBs	40
h3+ MCCBs thermal magnetic release	41
h3+ MCCBs microprocessor LSI release	42
h3+ MCCBs microprocessor LSIG release	43
h3+ MCCBs accessories	44
h3 MCCBs thermal magnetic release	45
MCCBs trip free switches	46
h2 MCCBs	47
Power Contactor, Overload Relay	48
Manual changeover switches	49
MCOS enclosures	50
Automatic transfer switch	51
Automatic changeover with current limiter - SPN	52
Automatic changeover with current limiter - TPN	53
h3 MCBs type NBN, NCN 0.5 to 63 A	54
h3 MCBs type NDN 0.5 to 63 A	55
MCBs type HLF 80 to 125 A	56
Auxilliaris & accessories	57
RCCBs	58
RCCB - type Hi (high immunity)	59
RCBOs - 2 pole 2 modules	60
RCBOs / RCBOs type Hi	61
RCBO, RCD+MCB modules	62
HRC fuse carriers	63
HRC cartridge fuses gG type	64
Surge protection devices	65
Modular changeover switches	66
Isolating switches	67
Ammeter Led, Spare, Voltage Protection Relay	68

Smart.
Safe.
Simple.

:hager

Our new range of **hws** Air Circuit Breakers are designed for maximum safety, reliable performance and installation flexibility to cater to all the customer needs with unmatched performance and following advantages :

- Safety and compliance
- Flexibility and adaptability
- Performance and reliability
- Advanced protection
- Easy installation and use
- Accessories and easy maintenance
- Communication and surveillance



HWS2M408D2AE : ACB HWS2 50kA 800A 4P DO LSIg

HWS	2	M	4	08	D	2	AE
Range	Frame	Breaking Capacity (Icu)	Pole	Rating (In)	Version	OCR	Internal Use
HWS	2 (630-2000A ACB 630 - 2500A SWITCH)	M - 50kA (Available in HWS2)	3	'06 = 630A	F - Fixed	1 - OCR STD LSI (Type "L" LSI)	
	4 (2000-4000A ACB 2000-4000A SWITCH)	E - 66kA (Available in HWS2 / HWS4)	4	'08 = 800A	D - Drawout	2 - OCR STD LSIg (Type "L" LSIg)	
		S - 85kA (Available in HWS4)		'10 = 1000A		3 - OCR AMP LSI (Type "A" LSI)	
		W - SW (SWITCH DISCONNECTOR)		'12 = 1250A		4 - OCR AMP LSIg (Type "A" LSIg)	
				'16 = 1600A		5 - OCR ENERGY LSIg (Type " H" LSIg)	
				'20 = 2000A		0 - SW (Without OCR)	
				'25 = 2500A			
				'32 = 3200A			
				'40 = 4000A			

Characteristics: HWS ACB have following features inbuilt

- DF door flange
- Rear vertical and horizontal Terminal connections
- Smart position Pad Locking
- Terminal Safety Shutter with Safety Shutter Padlock
- 4NO+4NC Aux Contacts
- Rack-in/rack-out handle
- Fault Indication
- Motor Spring Charging Indication with electrical version

OCR : Type L - LSING

			3 Pole		4 Pole	
Rating	Icu=Ics= Icw(1s)	Version	Cat. Ref.	Unit MRP (₹)	Cat. Ref.	Unit MRP (₹)
630A	50kA	MDO	HWS2M306D2AE	278671	HWS2M406D2AE	349783
800A			HWS2M308D2AE	278671	HWS2M408D2AE	349783
1000A			HWS2M310D2AE	292763	HWS2M410D2AE	366454
1250A			HWS2M312D2AE	325976	HWS2M412D2AE	405894
1600A			HWS2M316D2AE	370488	HWS2M416D2AE	452054
2000A			HWS2M320D2AE	516757	HWS2M420D2AE	634628

OCR : Type L - LSING

			3 Pole		4 Pole	
Rating	Icu=Ics= Icw(1s)	Version	Cat. Ref.	Unit MRP (₹)	Cat. Ref.	Unit MRP (₹)
630A	66kA	MDO	HWS2E306D2AE	323471	HWS2E406D2AE	405994
800A			HWS2E308D2AE	323471	HWS2E408D2AE	405994
1000A			HWS2E310D2AE	339822	HWS2E410D2AE	425369
1250A			HWS2E312D2AE	378367	HWS2E412D2AE	471128
1600A			HWS2E316D2AE	430034	HWS2E416D2AE	524729
2000A			HWS2E320D2AE	599832	HWS2E420D2AE	736646
2500A			HWS4E325D2AE	644825	HWS4E425D2AE	783583
3200A			HWS4E332D2AE	779620	HWS4E432D2AE	955930
4000A	85kA	MDO	HWS4S340D2AE	953510	HWS4S440D2AE	1224925



OCR : Type A - LSING+Display

			3 Pole		4 Pole	
Rating	Icu=Ics= Icw(1s)	Version	Cat. Ref.	Unit MRP (₹)	Cat. Ref.	Unit MRP (₹)
630A	50kA	MDO	HWS2M306D4AE	287819	HWS2M406D4AE	358932
800A			HWS2M308D4AE	287819	HWS2M408D4AE	358932
1000A			HWS2M310D4AE	301911	HWS2M410D4AE	375602
1250A			HWS2M312D4AE	335124	HWS2M412D4AE	415042
1600A			HWS2M316D4AE	379636	HWS2M416D4AE	461202
2000A			HWS2M320D4AE	525905	HWS2M420D4AE	643776

OCR : Type A - LSING+Display

			3 Pole		4 Pole	
Rating	Icu=Ics= Icw(1s)	Version	Cat. Ref.	Unit MRP (₹)	Cat. Ref.	Unit MRP (₹)
630A	66kA	MDO	HWS2E306D4AE	334087	HWS2E406D4AE	416621
800A			HWS2E308D4AE	334087	HWS2E408D4AE	416621
1000A			HWS2E310D4AE	350438	HWS2E410D4AE	435985
1250A			HWS2E312D4AE	388984	HWS2E412D4AE	481745
1600A			HWS2E316D4AE	440662	HWS2E416D4AE	535345
2000A			HWS2E320D4AE	610448	HWS2E420D4AE	747263
2500A			HWS4E325D4AE	654059	HWS4E425D4AE	792817
3200A			HWS4E332D4AE	788854	HWS4E432D4AE	965164
4000A	85kA	MDO	HWS4S340D4AE	962744	HWS4S440D4AE	1234159

Characteristics: HWS ACB have following features inbuilt

- DF door flange
- Rear vertical and horizontal Terminal connections
- 4NO+4NC Aux Contacts
- Fault Indication
- Motor Spring Charging Indication with electrical version



OCR : Type L - LSING

Rating	Icu=Ics= Icw(1s)	Version	3 Pole		4 Pole	
			Cat. Ref.	Unit MRP (₹)	Cat. Ref.	Unit MRP (₹)
630A	50kA	MF	HWS2M306F2AE	207805	HWS2M406F2AE	264204
800A			HWS2M308F2AE	207805	HWS2M408F2AE	264204
1000A			HWS2M310F2AE	227471	HWS2M410F2AE	286953
1250A			HWS2M312F2AE	261455	HWS2M412F2AE	326650
1600A			HWS2M316F2AE	290216	HWS2M416F2AE	375153
2000A			HWS2M320F2AE	389095	HWS2M420F2AE	508496

OCR : Type L - LSING

Rating	Icu=Ics= Icw(1s)	Version	3 Pole		4 Pole	
			Cat. Ref.	Unit MRP (₹)	Cat. Ref.	Unit MRP (₹)
630A	66kA	MF	HWS2E306F2AE	241207	HWS2E406F2AE	306677
800A			HWS2E308F2AE	241207	HWS2E408F2AE	306677
1000A			HWS2E310F2AE	264038	HWS2E410F2AE	333072
1250A			HWS2E312F2AE	303480	HWS2E412F2AE	379156
1600A			HWS2E316F2AE	336863	HWS2E416F2AE	435456
2000A			HWS2E320F2AE	451645	HWS2E420F2AE	590242
2500A			HWS4E325F2AE	478786	HWS4E425F2AE	604886
3200A			HWS4E332F2AE	685346	HWS4E432F2AE	845608
4000A			85kA	MF	HWS4S340F2AE	843988

OCR : Type A - LSING+Display

Rating	Icu=Ics= Icw(1s)	Version	3 Pole		4 Pole	
			Cat. Ref.	Unit MRP (₹)	Cat. Ref.	Unit MRP (₹)
630A	50kA	MF	HWS2M306F4AE	216953	HWS2M406F4AE	273353
800A			HWS2M308F4AE	216953	HWS2M408F4AE	273353
1000A			HWS2M310F4AE	236620	HWS2M410F4AE	296101
1250A			HWS2M312F4AE	270603	HWS2M412F4AE	335798
1600A			HWS2M316F4AE	299365	HWS2M416F4AE	384301
2000A			HWS2M320F4AE	398243	HWS2M420F4AE	517645

OCR : Type A - LSING+Display

Rating	Icu=Ics= Icw(1s)	Version	3 Pole		4 Pole	
			Cat. Ref.	Unit MRP (₹)	Cat. Ref.	Unit MRP (₹)
630A	66kA	MF	HWS2E306F4AE	251824	HWS2E406F4AE	317304
800A			HWS2E308F4AE	251824	HWS2E408F4AE	317304
1000A			HWS2E310F4AE	274666	HWS2E410F4AE	343688
1250A			HWS2E312F4AE	314096	HWS2E412F4AE	389783
1600A			HWS2E316F4AE	347490	HWS2E416F4AE	446072
2000A			HWS2E320F4AE	462262	HWS2E420F4AE	600858
2500A			HWS4E325F4AE	488020	HWS4E425F4AE	614120
3200A			HWS4E332F4AE	694580	HWS4E432F4AE	854842
4000A			85kA	MF	HWS4S340F4AE	853222

Note:
For EF Version Add MRP of Charging Motor, Shunt Trip Coil & Closing Coil over MF ACB MRP
OCR Type H prices available on request

Characteristics: HWS ACB have following features inbuilt

- DF door flange
- Rear vertical and horizontal Terminal connections
- 4NO+4NC Aux Contacts
- Motor Spring Charging
- Indication with electrical version



Without OCR		3 Pole		4 Pole	
Rating	Version	Cat. Ref.	Unit MRP (₹)	Cat. Ref.	Unit MRP (₹)
630A	MF	HWS2W306F0AE	196235	HWS2W406F0AE	255270
800A		HWS2W308F0AE	196235	HWS2W408F0AE	255270
1000A		HWS2W310F0AE	216821	HWS2W410F0AE	279082
1250A		HWS2W312F0AE	252392	HWS2W412F0AE	320634
1600A		HWS2W316F0AE	282498	HWS2W416F0AE	371403
2000A		HWS2W320F0AE	385997	HWS2W420F0AE	510978
2500A		HWS2W325F0AE	475238	HWS2W425F0AE	606010
3200A		HWS4W332F0AE	689450	HWS4W432F0AE	855646
4000A		HWS4W340F0AE	853966	HWS4W440F0AE	1076018

Without OCR : Type L - LSING		3 Pole		4 Pole	
Rating	Version	Cat. Ref.	Unit MRP (₹)	Cat. Ref.	Unit MRP (₹)
630A	MDO	HWS2W306D0AE	270413	HWS2W406D0AE	344848
800A		HWS2W308D0AE	270413	HWS2W408D0AE	344848
1000A		HWS2W310D0AE	294739	HWS2W410D0AE	362298
1250A		HWS2W312D0AE	319928	HWS2W412D0AE	403581
1600A		HWS2W316D0AE	366520	HWS2W416D0AE	451898
2000A		HWS2W320D0AE	519624	HWS2W420D0AE	643003
2500A		HWS2W325D0AE	647427	HWS2W425D0AE	791325
3200A		HWS4W332D0AE	787214	HWS4W432D0AE	970054
4000A		HWS4W340D0AE	967546	HWS4W440D0AE	1249013

Note:
For EF/EDO Version Add MRP of Charging Motor, Shunt Trip Coil & Closing Coil over MF/MDO ACB MRP



Cat. Ref.	Description	Unit MRP (₹)
HSX014H	Charging motor 200V-250 V AC HWS (MO)	62424
HSX016H	Charging motor 415V-450 V AC HWS (MO)	62424
HSX714H	Charging motor 100V-130 V DC HWS (MO)	63591
HSX716H	Charging motor 200V-250 V DC HWS (MO)	63591
HSX023H	Shunt trip coil 240V AC HWS (SH)	9084
HSX024H	Shunt trip coil 415V AC HWS (SH)	9084
HSX723H	Shunt trip coil 110V DC HWS (SH)	9254
HSX724H	Shunt trip coil 220V DC HWS (SH)	9254
HSX028H	Closing Coil 240V AC HWS (CC)	9084
HSX029H	Closing Coil 415V AC HWS (CC)	9084
HSX728H	Closing Coil 110V DC HWS (CC)	9254
HSX729H	Closing Coil 220V DC HWS (CC)	9254
HSX033H	Undervoltage trip 240V AC HWS (UV)	9084
HSX034H	Undervoltage trip 415V AC HWS (UV)	9084
HSY033H	Undervoltage Time Delay Controller 240V AC (UVTC)	14933
HSY034H	Undervoltage Time Delay Controller 415V AC (UVTC)	14933



Cat. Ref.	Description	Unit MRP (₹)
HSX042H	Aux switch 4NO+4NC HWS (AX)	8004
HSX043H	Aux switch 6NO+6NC HWS (AX)	10005
HSX050H	Position Switch HWS (PS)	7865
HSX092H	Ready To Close contact HWS (RTC)	4601
HSY100H	Terminal Block Cover HWS (TBC)	5450
HSY261H	OFF locking RONIS 1L+1K HWS (OLK)	5646
HSY262H	OFF locking RONIS 2L+1K HWS (OLK)	8469
HSY263H	OFF locking RONIS 3L+2K HWS (OLK)	14116
HSY264H	OFF locking RONIS 5L+3K HWS (OLK)	25408
HSY950H	Terminal Block "Type A" HWS (TB)	1690
HSY951H	Terminal Block "Type B" HWS (TB)	1690
HSY970H	External sensor 630-1600A HWS2 (ENCT)	10072
HSY971H	External sensor 2000A HWS2 (ENCT)	11118
HSY972H	External sensor 2000-4000A HWS4 (ENCT)	15260
HWY286H	Door Flange HT for HW2 Fixed (DF)	4815
HWY287H	Door Flange HT for HW2 Draw-out (DF)	4815
HWY290H	Door Flange HT for HW4 Fixed (DF)	4815
HWY291H	Door Flange HT for HW4 Draw-out (DF)	4815
HWY090H	Push Button Cover HWS2-HWS4 (PBC)	4494
HWX071H	ON/OFF cycle counter HWS2/4 (CYC)	13769
HWY277H	Racking interlock door open HWS2/4 (RI)	2675
HWY239H	Chassis locking Ronis type HWS2/4 (CL)	4815
HWY271H	Wrong insertion preventer HWS2/4 (WIP)	6955



HHS025DR

h3+ MCCBs microprocessor LSI release

Characteristics:

- Complies with IEC 60947-2
- 3 Frame sizes: P160 , P250 & P630
- Microprocessor Trip Unit with LSI Protection
- Adjustable Overload with Delay / Short Circuit with adjustable Delay / Instantaneous
- I2T ON / OFF for precise coordination
- Dedicated Pre Trip Alarm Contact to help in service continuity

- Accurate setting of overload protection
- Neutral Protection for all 4P breakers as standard (option of OFF / 50% / 100% Neutral setting)
- Complete range of accessories
- Direct mounting arrangement for Extended Rotary Handle for quick installation
- International Certification and approvals

Breaking Capacity
Ics=100% Icu as per IEC 60947-2)

Rated Current	Frame	Cat. Ref. 3 Pole	Unit MRP (₹)	Cat. Ref. 4 Pole	Unit MRP (₹)	
25kA	40A	P160	HHS040JR	23315	HHS041JR	30281
	100A		HHS100JR	23315	HHS101JR	29992
	160A	P250	HHS160JR	29778	HHS161JR	38541
	250A		HHT250JR	39141	HHT251JR	50204

Breaking Capacity
Ics=100% Icu as per IEC 60947-2)

Rated Current	Frame	Cat. Ref. 3 Pole	Unit MRP (₹)	Cat. Ref. 4 Pole	Unit MRP (₹)	
40kA	40A	P160	HNS040JR	23369	HNS041JR	29725
	100A		HNS100JR	23369	HNS101JR	29725
	160A		HNS160JR	29874	HNS161JR	41976
	250A	P250	HNT250JR	41195	HNT251JR	56271
	400A		HNW400JR	65431	HNW401JR	74697
	630A		HNW630JR	69165	HNW631JR	89666

Breaking Capacity
Ics=100% Icu as per IEC 60947-2)

Rated Current	Frame	Cat. Ref. 3 Pole	Unit MRP (₹)	Cat. Ref. 4 Pole	Unit MRP (₹)	
50kA	40A	P160	HMS040JR	26878	HMS041JR	36819
	100A		HMS100JR	26878	HMS101JR	37921
	160A		HMS160JR	34080	HMS161JR	44127
	250A	P250	HMT250JR	46181	HMT251JR	63237
	400A		HMW400JR	68480	HMW401JR	88842
	630A		HMW630JR	70898	HMW631JR	93935

h3+ Range Overview Electronic Releases

LSI
LSIG

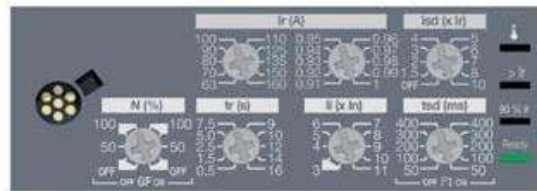

Trip unit LSI/G

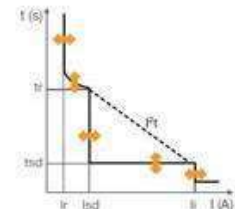

- + Easy Dial Settings in Absolute Value for Ir
- + Rated Current Settings with Fine Tuning From 35% of In
- + I2t On / Off Feature for precise coordination

L – Long Time / S – Short Time / I – Instantaneous / G – Ground Fault
LSI – S with adjustable delay



HHT250LR

h3+ MCCBs microprocessor LSIG release

Characteristics:

- Complies with IEC 60947-2
- 3 Frame sizes: P160, P250 & P630
- Microprocessor Trip Unit with LSIG Protection
- Adjustable Overload with Delay / Short Circuit with adjustable Delay / Ground Fault / Instantaneous
- I2T ON / OFF for precise coordination
- Dedicated PreTrip Alarm Contact to help in service continuity
- Accurate setting of overload protection
- Neutral Protection for all 4P breakers as standard (option of OFF / 50% / 100% Neutral setting)
- Complete range of accessories
- Direct mounting arrangement for Extended Rotary Handle for quick installation
- International Certification and approvals

Breaking Capacity

Ics=100% Icu as per IEC 60947-2	Rated Current	Frame	Cat. Ref. 3 Pole	Unit MRP (₹)	Cat. Ref. 4 Pole	Unit MRP (₹)
25kA	40A	P250	HHT040LR	41998	HHT041LR	47005
	100A		HHT100LR	41998	HHT101LR	47005
	160A		HHT160LR	44416	HHT161LR	53404
	250A	HHT250LR	50857	HHT251LR	60937	

Breaking Capacity

Ics=100% Icu as per IEC 60947-2	Rated Current	Frame	Cat. Ref. 3 Pole	Unit MRP (₹)	Cat. Ref. 4 Pole	Unit MRP (₹)
40kA	40A	P250	HNT040LR	42201	HNT041LR	48856
	100A		HNT100LR	42201	HNT101LR	48856
	160A		HNT160LR	45903	HNT161LR	55116
	250A	P630	HNT250LR	51467	HNT251LR	63847
	400A		HNW400LR	73124	HNW401LR	83203
	630A		HNW630LR	84027	HNW631LR	98911

Breaking Capacity

Ics=100% Icu as per IEC 60947-2	Rated Current	Frame	Cat. Ref. 3 Pole	Unit MRP (₹)	Cat. Ref. 4 Pole	Unit MRP (₹)
50kA	40A	P250	HMT040LR	45903	HMT041LR	52601
	100A		HMT100LR	45903	HMT101LR	52601
	160A		HMT160LR	52109	HMT161LR	56346
	250A	P630	HMT250LR	55683	HMT251LR	65366
	400A		HMW400LR	75157	HMW401LR	89752
	630A		HMW630LR	84327	HMW631LR	105235

h3+ Key Benefits



Integrated PTA output contact
Output contact dedicated to the overload prealarm.

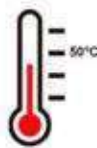

No derating up to 50°C



High contrast display
Display on h3+ Energy breakers can be oriented in any direction to match the MCCB orientation.



Integrated OAC output contact
Output contact assignable to a custom alarm with access behind the front cover. Available in Energy release

h3+ traditional version

Guaranteed protection

The new range of moulded case circuit breakers provides solutions suitable for electrical installations in commercial buildings. It offers reliable protection against overloads and short circuits.

The multiple setting options, created by coordinating the protection systems, offer the best possible combinations. This brings a threefold benefit: guaranteeing user and equipment safety under all conditions, ensuring continuity of service and availability of energy in normal operating situations, and, in case of transient faults, reducing the risks to the installation's components.



All products in the new range can be easily integrated in the hager enclosure systems.



- Most compact product on the market with measurement and communication.
- From 25 to 630 A
- Three frame sizes
- Can be mounted on the DIN rail in option up to 250 A
- LSI, LSIg
- Breaking capacity of 25, 40, 50, 70 and 110 kA at 415 VAC
- 3P3D or 4P4D (neutral adjustable to 0, 50 or 100 %)
- Wide range of auxiliaries and accessories
- Horizontal or vertical installation

01

Secure screw

The quarter-turn auxiliary access system saves time when installing the product. The secure screw offers additional comfort.



02

Hinged front cover

The front cover offers multiple advantages. It is mounted on hinges. It remains integral with the case once opened, preventing incorrect refitting.



03

Auxiliary window

The type of auxiliaries can be seen directly through the windows on the front panel, without removing the cover.

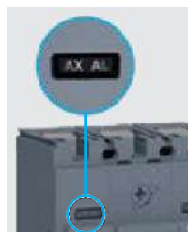

04

Integrated padlock

The handle can be directly locked with no need for extra accessories.



All the technical specifications are available in the technical repository and the network calculation software, hagercad.net.



HXA011H

Description	Pack Qty.	Cat. Ref.	Unit MRP (₹)
P160 Frame			
Auxiliary Contact	1	HXA021H	1693
Alarm Contact	1	HXA024H	1693
Shunt 230V AC	1	HXA004H	3501
UnderVoltage - 240V DC	1	HXA014H	4347
UnderVoltage - 415V AC	1	HXA015H	4285
Direct Rotary Handle	1	HXS030H	1714
Extended Rotary Handle	1	HXS031H	2738
Spreaders - 3P	1	HYS011H	930
Spreaders - 4P	1	HYS012H	1212
Interphase barrier 3/4P	1	HYS019H	575



HXA004H

Description	Pack Qty.	Cat. Ref.	Unit MRP (₹)
P250 Frame			
Auxiliary Contact	1	HXA021H	1693
Alarm Contact	1	HXA024H	1693
Shunt 230V AC	1	HXA004H	3501
UnderVoltage - 240V DC	1	HXA014H	4347
UnderVoltage - 415V AC	1	HXA015H	4285
Direct Rotary Handle	1	HXT030H	1871
Extended Rotary Handle	1	HXT031H	2978
Spreaders - 3P	1	HYB011H	930
Spreaders - 4P	1	HYB012H	1275
Interphase barrier 3/4P	1	HYT019H	585
Motor Mechanism (auto reset) 240V AC	1	HXT042H	34401



HXW030H

Description	Pack Qty.	Cat. Ref.	Unit MRP (₹)
P630 Frame			
Auxiliary Contact	1	HXA021H	1693
Alarm Contact	1	HXA024H	1693
Shunt 230V AC	1	HXA004H	3501
UnderVoltage - 240V DC	1	HXA014H	4347
UnderVoltage - 415V AC	1	HXA015H	4285
Direct Rotary Handle	1	HXW030H	2863
Direct Rotary Handle	1	HXW031H	5403
Spreaders - 3P	1	HYD014H	2424
Spreaders - 4P	1	HYD015H	2874
Interphase barrier 3/4P	1	HYW019H	1244
Motor Mechanism (auto reset) 240V AC	1	HXW042H	54821

HDA125Z
MCCBs thermal magnetic release
Characteristics:

- Complies with IEC 60947-2
- Thermal Magnetic and Microprocessor Trip Units
- Calibrated at 50°C

- Current Limiting type
- Complete range of accessories
- International Certification and approvals
- BIS certified

**X160 frame MCCB
fixed overload, fixed short circuit**

 breaking capacity
 Icu : 18kA

Description	Pack Qty.	Cat. Ref.	Unit MRP (₹)
32A, 3 pole	1	HDA032Z	7540
40A, 3 pole	1	HDA040Z	7540
63A, 3 pole	1	HDA063Z	7830
80A, 3 pole	1	HDA080Z	7830
100A, 3 pole	1	HDA100Z	7830
125A, 3 pole	1	HDA125Z	9204
160A, 3 pole	1	HDA160Z	10324

HHA125Z

32A, 4 pole	1	HDA033Z	8674
40A, 4 pole	1	HDA041Z	8674
63A, 4 pole	1	HDA064Z	9007
80A, 4 pole	1	HDA081Z	9007
100A, 4 pole	1	HDA101Z	9007
125A, 4 pole	1	HDA126Z	9984
160A, 4 pole	1	HDA161Z	10878

**X160 frame MCCB
fixed overload, fixed short circuit**

 breaking capacity
 Icu : 25kA

Description	Pack Qty.	Cat. Ref.	Unit MRP (₹)
32A, 3 pole	1	HHA032Z	9360
40A, 3 pole	1	HHA040Z	9360
63A, 3 pole	1	HHA063Z	9225
80A, 3 pole	1	HHA080Z	9225
100A, 3 pole	1	HHA100Z	9225
125A, 3 pole	1	HHA125Z	12917
160A, 3 pole	1	HHA160Z	15368

32A, 4 pole	1	HHA033Z	12761
40A, 4 pole	1	HHA041Z	12761
63A, 4 pole	1	HHA064Z	13065
80A, 4 pole	1	HHA081Z	12761
100A, 4 pole	1	HHA101Z	13252
125A, 4 pole	1	HHA126Z	15769
160A, 4 pole	1	HHA161Z	20073



HDA161U

X160 frame MCCB
overload adjustable 0.63-0.8-1 x In
short circuit fixed
breaking capacity
Icu : 18kA

Description	Pack Qty.	Cat. Ref.	Unit MRP (₹)
40A, 3 pole	1	HDA040U	8497
63A, 3 pole	1	HDA063U	8497
80A, 3 pole	1	HDA080U	8497
100A, 3 pole	1	HDA100U	8497
125A, 3 pole	1	HDA125U	10109
160A, 3 pole	1	HDA160U	11700
40A, 4 pole	1	HDA041U	11118
63A, 4 pole	1	HDA064U	10962
80A, 4 pole	1	HDA081U	10962
100A, 4 pole	1	HDA101U	10962
125A, 4 pole	1	HDA126U	11617
160A, 4 pole	1	HDA161U	12927



HHA161U

X160 frame MCCB
overload adjustable 0.63-0.8-1 x In
short circuit fixed
breaking capacity
Icu : 25kA

Description	Pack Qty.	Cat. Ref.	Unit MRP (₹)
40A, 3 pole	1	HHA040U	10670
63A, 3 pole	1	HHA063U	10670
80A, 3 pole	1	HHA080U	10670
100A, 3 pole	1	HHA100U	10670
125A, 3 pole	1	HHA125U	12823
160A, 3 pole	1	HHA160U	17446
40A, 4 pole	1	HHA041U	14425
63A, 4 pole	1	HHA064U	14425
80A, 4 pole	1	HHA081U	14425
100A, 4 pole	1	HHA101U	15721
125A, 4 pole	1	HHA126U	18492
160A, 4 pole	1	HHA161U	20457



HNA126U

X160 frame MCCB
overload adjustable 0.63-0.8-1 x In
short circuit fixed
breaking capacity
Icu : 40kA

Description	Pack Qty.	Cat. Ref.	Unit MRP (₹)
40A, 3 pole	1	HNA040U	13198
63A, 3 pole	1	HNA063U	13198
80A, 3 pole	1	HNA080U	13198
100A, 3 pole	1	HNA100U	13198
125A, 3 pole	1	HNA125U	15829
160A, 3 pole	1	HNA160U	19791
40A, 4 pole	1	HNA041U	17534
63A, 4 pole	1	HNA064U	17534
80A, 4 pole	1	HNA081U	17534
100A, 4 pole	1	HNA101U	17534
125A, 4 pole	1	HNA126U	20735
160A, 4 pole	1	HNA161U	22318



HNB100U

X250 frame MCCB
fixed overload, fixed short circuit
Icu : 25kA

Description	Pack Qty.	Cat. Ref.	Unit MRP (₹)
200A, 3 pole	1	HNB200Z	20524
250A, 3 pole	1	HNB250Z	25779
200A, 4 pole	1	HNB201Z	21165
250A, 4 pole	1	HNB251Z	27125

Over load adjustable 0.63-0.8-1 x In
short circuit adjustable
6-8-10-13 x In (100-200A)
5-7-9-11 x In (250A)
Icu : 40kA

Description	Pack Qty.	Cat. Ref.	Unit MRP (₹)
100A, 3 pole	1	HNB100U	16131
125A, 3 pole	1	HNB125U	17978
160A, 3 pole	1	HNB160U	23780
200A, 3 pole	1	HNB200U	24875
250A, 3 pole	1	HNB250U	34006
100A, 4 pole	1	HNB101U	20668
125A, 4 pole	1	HNB126U	21706
160A, 4 pole	1	HNB161U	27371
200A, 4 pole	1	HNB201U	36058
250A, 4 pole	1	HNB251U	40926

H1000 frame MCCB
Over load adjustable 0.4-1.0 x In
short circuit adjustable
2.5-10 x Ir (630-800A)
2.5-8 x In (1000A)
time delay 0.1-0.2 sec
Icu : 50kA

Description	Pack Qty.	Cat. Ref.	Unit MRP (₹)
800A, 3 pole	1	HNE800H	148753
1000A, 3 pole	1	HNE970H	176548
800A, 4 pole	1	HNE801H	185576
1000A, 4 pole	1	HNE971H	234635



HXA021H

Description	Pack Qty.	Cat. Ref.	Unit MRP (₹)
X160 Frame MCCB			
Auxiliary Contact	1	HXA021H	1693
Alarm Contact	1	HXA024H	1693
Shunt 230V AC	1	HXA004H	3501
UnderVoltage - 240V AC	1	HXA014H	4347
UnderVoltage - 415V AC	1	HXA015H	4285
Direct Rotary Handle	1	HXA030H	2153
Extended Rotary Handle	1	HXA031H	2957
Spreaders - 3P	1	HYA014H	815
Speaders - 4P	1	HYA015H	1097
Phase barriers - 3P / 4P	1	HYB019H	314
DIN Rail Adaptor	1	HYA033H	606



HXA030H

Description	Pack Qty.	Cat. Ref.	Unit MRP (₹)
X250 Frame MCCB			
Auxiliary Contact	1	HXA021H	1693
Alarm Contact	1	HXA024H	1693
Shunt 230V AC	1	HXA004H	3501
UnderVoltage - 240V AC	1	HXA014H	4347
UnderVoltage - 415V AC	1	HXA015H	4285
Direct Rotary Handle	1	HXB030H	2268
Extended Rotary Handle	1	HXB031H	3354
Motor Operator 240VAC	1	HXB042H	34788
Spreaders - 3P	1	HYB011H	930
Speaders - 4P	1	HYB012H	1275
Phase barriers - 3P / 4P	1	HYB019H	314



HXC021H

Description	Pack Qty.	Cat. Ref.	Unit MRP (₹)
H1000 Frame MCCB			
Auxiliary Contact	1	HXC021H	1829
Alarm Contact	1	HXC024H	1829
Shunt 230V AC	1	HXC004H	4253
UnderVoltage - 240V AC	1	HXE014H	3741
UnderVoltage - 240V AC	1	HXE031H	8736
Motor Operator 240VAC	1	HXE042H	56430

Characteristics:

- Complies with IEC 60947-2
- 5 Frame sizes: N125, N160, N250, N400 & N630
- Thermal Magnetic Trip Unit with adjustable O/L and Fixed S/C
- Adjustable Overload from 80% to 100%In
- S/C Setting fixed at 10x In
- Calibrated at 50°C
- Current Limiting type
- Complete range of accessories
- BIS certified



Breaking Capacity Ics=100% Icu as per IEC 60947-2	Rated Current	Frame	Cat. Ref. 3 Pole	Unit MRP (₹)	Cat. Ref. 4 Pole	Unit MRP (₹)
18kA	40A	N125	HDP040UN	8406	HDP041UN	9099
	63A	N125	HDP063UN	8406	HDP064UN	9099
	80A	N125	HDP080UN	8406	HDP081UN	9099
	100A	N125	HDP100UN	8406	HDP101UN	9099
	125A	N125	HDP125UN	8787	HDP126UN	9589
	160A	N160	HDQ160UN	9776	HDQ161UN	10410
	200A	N250	HDR200UN	19915	HDR201UN	20146
	250A	N250	HDR250UN	24686	HDR251UN	25991



Breaking Capacity Ics=100% Icu as per IEC 60947-2	Rated Current	Frame	Cat. Ref. 3 Pole	Unit MRP (₹)	Cat. Ref. 4 Pole	Unit MRP (₹)
25kA	40A	N125	HHP040UN	9974	HHP041UN	12582
	63A	N125	HHP063UN	9974	HHP064UN	12582
	80A	N125	HHP080UN	9974	HHP081UN	12582
	100A	N125	HHP100UN	9974	HHP101UN	12582
	125A	N125	HHP125UN	9974	HHP126UN	15266
	160A	N160	HHQ160UN	14585	HHQ161UN	19715
	200A	N250	HHR200UN	22902	HHR201UN	23168
	250A	N250	HHR250UN	28389	HHR251UN	29890

Breaking Capacity Ics=100% Icu as per IEC 60947-2	Rated Current	Frame	Cat. Ref. 3 Pole	Unit MRP (₹)	Cat. Ref. 4 Pole	Unit MRP (₹)
36kA	40A	N125	HGQ040UN	11737	HGQ041UN	13514
	63A	N125	HGQ063UN	11737	HGQ064UN	13514
	80A	N125	HGQ080UN	11737	HGQ081UN	13514
	100A	N125	HGQ100UN	11737	HGQ101UN	13514
	125A	N125	HGQ125UN	11737	HGQ126UN	13514
	160A	N160	HGQ160UN	16969	HGQ161UN	20363
	200A	N250	HGR200UN	24047	HGR201UN	25249
	250A	N250	HGR250UN	29808	HGR251UN	31895
	320A	N400	HGU320UN	32789	HGU321UN	38063
	400A	N400	HGU400UN	32789	HGU401UN	38063
	630A	N630	HGU630UN	37382	HGU631UN	45534

N125 Frame MCCB	Pack Qty.	Cat. Ref.	Unit MRP (₹)
Aux contact 1CO (N125) Left	1	HXP021LN	960
Aux contact 1CO (N125) Right	1	HXP021RN	960
AL contact 1CO N125 Left	1	HXP024LN	960
Aux+AL contact 1CO N125 Left	1	HXP023LN	1650
SHT (230V AC) Left (N125)	1	HXP004LN	1350
SHT (230V AC) Right (N125)	1	HXP004RN	1350
UVR (230V AC) N125 Left	1	HXP014LN	4095
UVR (230V AC) N125 Right	1	HXP014RN	4095
UVR (415V AC) N125 Right	1	HXP015RN	4095
Extended Rotary handle N125	1	HXP031HN	2000
Spreader N125 3P	1	HYP014HN	315
Spreader N125 4P	1	HYP015HN	995
Phase barriers N125	1	HXP019HN	195



Auxiliary Contact (AX)

N160 Frame MCCB	Pack Qty.	Cat. Ref.	Unit MRP (₹)
Aux contact 1CO (N160) Left	1	HXQ021LN	960
Aux contact 1CO (N160) Right	1	HXQ021RN	960
AL contact 1CO N160 Left	1	HXQ024LN	960
Aux+AL contact 1CO N160 Left	1	HXQ023LN	1650
SHT (230V AC) Left (N160)	1	HXQ004LN	2890
SHT (230V AC) Right (N160)	1	HXQ004RN	2890
UVR (230V AC) N160 Right	1	HXQ014RN	4050
UVR (415V AC) N160 Right	1	HXQ015RN	4050
Extended Rotary handle N160	1	HXQ031HN	2000
Spreader N160 3P	1	HYQ014HN	315
Spreader N160 4P	1	HYQ015HN	820
Phase barriers N125	1	HXP019HN	195



Alarm Contact (AL)

N250 Frame MCCB	Pack Qty.	Cat. Ref.	Unit MRP (₹)
Aux contact 1CO (N250) Left	1	HXR021LN	1170
Aux contact 1CO (N250) Right	1	HXR021RN	1170
AL contact 1CO N250 Left	1	HXR024LN	1170
AL contact 1CO N250 Right	1	HXR024RN	1170
Aux+AL contact 1CO N250 Left	1	HXR023LN	2010
SHT (230V AC) Left (N250)	1	HXR004LN	2065
SHT (230V AC) Right (N250)	1	HXR004RN	2065
UVR (230V AC) N250 Right	1	HXR014RN	4050
UVR (415V AC) N250 Right	1	HXR015RN	4050
Extended Rotary handle N250	1	HXR031HN	2000
Spreader N250 3P	1	HYR014HN	815
Spreader N250 4P	1	HYR015HN	1040
Phase barriers N250	1	HXR019HN	195



Auxiliary + Alarm Contact (AX+AL)



Undervoltage release UV

N400/N630 Frame MCCB	Pack Qty.	Cat. Ref.	Unit MRP (₹)
Aux contact 1CO (N630) Left	1	HXU021LN	1170
Aux contact 1CO (N630) Right	1	HXU021RN	1170
AL contact 1CO N630 Left	1	HXU024LN	1170
AL contact 1CO N630 Right	1	HXU024RN	1170
Aux+AL contact 1CO N630 Left	1	HXU023LN	2010
SHT (230V AC) Left (N630)	1	HXU004LN	3360
SHT (230V AC) Right (N630)	1	HXU004RN	3360
UVR (230V AC) N630 Left	1	HXU014LN	4050
UVR (415V AC) N630 Left	1	HXU015LN	4050
Extended Rotary handle N630	1	HXU031HN	3115
Spreader N630 3P	1	HYU014HN	2290
Spreader N630 4P	1	HYU015HN	2755
Phase barriers N630	1	HXU019HN	195



Shunt trip coil SH

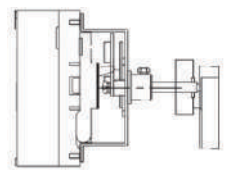

Extended Rotary handle



Power Contactor

Characteristics:

- 9A to 630 A Rated Current - 690V insulation voltage - Wide operating coil - 3 pole

Model	AC3 Rating (A)	Coil voltage	Aux	Pack Qty.	Cat. Ref.	Unit MRP (₹)
HWC-09	9A	110V 50/60Hz	1NO+1NC	1	EX000911C	1333
	9A	230V 50/60Hz	1NO+1NC	1	EX000911D	1333
	9A	415V 50/60Hz	1NO+1NC	1	EX000911E	1333
HWC-12	12A	110V 50/60Hz	1NO+1NC	1	EX001211C	1487
	12A	230V 50/60Hz	1NO+1NC	1	EX001211D	1487
	12A	415V 50/60Hz	1NO+1NC	1	EX001211E	1487
HWC-16	16A	110V 50/60Hz	1NO+1NC	1	EX001611C	1711
	16A	230V 50/60Hz	1NO+1NC	1	EX001611D	1711
	16A	415V 50/60Hz	1NO+1NC	1	EX001611E	1711
HWC-18	18A	110V 50/60Hz	1NO+1NC	1	EX001811C	1711
	18A	230V 50/60Hz	1NO+1NC	1	EX001811D	1711
	18A	415V 50/60Hz	1NO+1NC	1	EX001811E	1711
HWC-22	22A	110V 50/60Hz	1NO+1NC	1	EX002211C	2419
	22A	230V 50/60Hz	1NO+1NC	1	EX002211D	2419
	22A	415V 50/60Hz	1NO+1NC	1	EX002211E	2419
HWC-25	25A	110V 50/60Hz	1NO+1NC	1	EX002511C	2419
	25A	230V 50/60Hz	1NO+1NC	1	EX002511D	2419
	25A	415V 50/60Hz	1NO+1NC	1	EX002511E	2419
HWC-32	32A	110V 50/60Hz	1NO+1NC	1	EX003211C	4673
	32A	230V 50/60Hz	1NO+1NC	1	EX003211D	4673
	32A	415V 50/60Hz	1NO+1NC	1	EX003211E	4673
HWC-40	40A	110V 50/60Hz	1NO+1NC	1	EX004011C	7351
	40A	230V 50/60Hz	1NO+1NC	1	EX004011D	7351
	40A	415V 50/60Hz	1NO+1NC	1	EX004011E	7351
HWC-50	50A	110V 50/60Hz	1NO+1NC	1	EX005011C	9086
	50A	230V 50/60Hz	1NO+1NC	1	EX005011D	9086
	50A	415V 50/60Hz	1NO+1NC	1	EX005011E	9086
HWC-65	65A	110V 50/60Hz	1NO+1NC	1	EX006511C	12437
	65A	230V 50/60Hz	1NO+1NC	1	EX006511D	12437
	65A	415V 50/60Hz	1NO+1NC	1	EX006511E	12437
HWC-75	75A	110V 50/60Hz	1NO+1NC	1	EX007511C	15977
	75A	230V 50/60Hz	1NO+1NC	1	EX007511D	15977
	75A	415V 50/60Hz	1NO+1NC	1	EX007511E	15977
HWC-85	85A	110V 50/60Hz	1NO+1NC	1	EX008511C	15977
	85A	230V 50/60Hz	1NO+1NC	1	EX008511D	15977
	85A	415V 50/60Hz	1NO+1NC	1	EX008511E	15977
HWC-100	100A	110V 50/60Hz	1NO+1NC	1	EX010011C	20131
	100A	230V 50/60Hz	1NO+1NC	1	EX010011D	20131
	100A	415V 50/60Hz	1NO+1NC	1	EX010011E	20131
HWC-160	160A	110V 50/60Hz	2NO+2NC	1	EX016022C	31978
	160A	230V 50/60Hz	2NO+2NC	1	EX016022D	31978
	160A	415V 50/60Hz	2NO+2NC	1	EX016022E	31978
HWC-185	185A	110V 50/60Hz	2NO+2NC	1	EX018522C	34114
	185A	230V 50/60Hz	2NO+2NC	1	EX018522D	34114
	185A	415V 50/60Hz	2NO+2NC	1	EX018522E	34114
HWC-225	225A	110V 50/60Hz	2NO+2NC	1	EX022522C	37040
	225A	230V 50/60Hz	2NO+2NC	1	EX022522D	37040
	225A	415V 50/60Hz	2NO+2NC	1	EX022522E	37040
HWC-265	265A	110V AC/DC	2NO+2NC	1	EX026522C	47507
	265A	230V AC/DC	2NO+2NC	1	EX026522G	47507
	265A	415V AC/DC	2NO+2NC	1	EX026522H	47507
HWC-330	330A	110V AC/DC	2NO+2NC	1	EX033022F	61962
	330A	230V AC/DC	2NO+2NC	1	EX033022G	61962
	330A	415V AC/DC	2NO+2NC	1	EX033022H	61962
HWC-400	400A	110V AC/DC	2NO+2NC	1	EX040022F	78777
	400A	230V AC/DC	2NO+2NC	1	EX040022G	78777
	400A	415V AC/DC	2NO+2NC	1	EX040022H	78777
HWC-630	630A	110V AC/DC	2NO+2NC	1	EX063022F	109917
	630A	230V AC/DC	2NO+2NC	1	EX063022G	109917
	630A	415V AC/DC	2NO+2NC	1	EX063022H	109917





OLR (OverLoad Relay)

Characteristics:

- Phase loss protection
- Auto and Manual reset
- Three Phase bimetal for overload protection
- Applicable for 3P HWC Contactor Range

Model	Overload Protection Range	Pack Qty.	Cat. Ref.	Unit MRP (₹)
HWR-25	1.6-2.5A	1	EXB00025B	2195
	2.5-4A	1	EXB00004B	2195
	4-6A	1	EXB00006B	2195
	5.5-8A	1	EXB00008B	2195
	7-10A	1	EXB00010B	2195
	9-13A	1	EXB00013B	2195
	12-18A	1	EXB00018B	2195
	17-25A	1	EXB000025B	2195
HWR-38	23A-32A	1	EXB00032C	3823
	30A-38A	1	EXB00038C	3823
	23A-32A	1	EXB000032C	6726
	30A-40A	1	EXB00040C	6726
HWR-100	37A-50A	1	EXB00050C	6726
	48A-65A	1	EXB00065C	6726
	55A-70A	1	EXB00070C	6726
	63A-80A	1	EXB00080C	6726
	80A-100A	1	EXB00100C	6726
HWR-200	100A-200A	1	EXB00200E	22868
	125A-250A	1	EXB00250F	27388
HWR-630	200A-400A	1	EXB00400F	27388
	315A-630A	1	EXB00630F	27388

Accessories for Power Contactor

Description	Pack Qty.	Cat. Ref.	Unit MRP (₹)
Aux Contact 2NO Top Mounted	10	EXA000	519
Aux Contact 1NO+1NC Top Mounted	10	EXA001	519
Aux Contact 2NC Top Mounted	10	EXA002	519
Aux Contact 4NO Top Mounted	10	EXA003	979
Aux Contact 3NO+1NC Top Mounted	10	EXA004	979
Aux Contact 2NO+2NC Top Mounted	10	EXA005	979
Aux Contact 1NO+3NC Top Mounted	10	EXA006	979
Aux Contact 1NC Top Mounted	10	EXA007	979
Aux Contact 1NO+1NC Side Mounted HWC-06~225	10	EXA111	1015
Aux Contact 1NO+1NC Side Mounted HWC-265~630	10	EXA112	1015
HWC-09-22 coil 110V 50/60Hz	5	EXA201	968
HWC-09-22 coil 230V 50/60Hz	5	EXA202	968
HWC-09-22 coil 415V 50/60Hz	5	EXA203	968
HWC-25-32 coil 110V 50/60Hz	7	EXA211	1003
HWC-25-32 coil 230V 50/60Hz	7	EXA212	1003
HWC-25-32 coil 415V 50/60Hz	7	EXA213	1003
HWC-40-65 coil 110V 50/60Hz	2	EXA221	1416
HWC-40-65 coil 230V 50/60Hz	2	EXA222	1416
HWC-40-65 coil 415V 50/60Hz	2	EXA223	1416
HWC-75-100 coil 110V 50/60Hz	2	EXA231	1805
HWC-75-100 coil 230V 50/60Hz	2	EXA232	1805
HWC-75-100 coil 415V 50/60Hz	2	EXA233	1805



HI451I



HZC101I



HZC204I



VYE63M

Manual changeover switches

Characteristics:

- Comply with EN 60 947-3
- Manual changeover switches,
- Rating 63 to 100A
- Allows manual switch,
- changeover switch or on load
- power circuit permutation
- Connection with terminals
- For safety breaking:
- 4P
- mounting on perforated plates or crossbars
- lockable on position: I, O or II

Changeover switches

Description	Pack Qty.	Cat. Ref.	Unit MRP (₹)
63A	1	HI403I	7761
100A	1	HI405I	11336
125A	1	HI451I	17244
160A	1	HI452I	18922
250A	1	HI454I	31675
400A	1	HI456I	46946
630A	1	HI458I	57716
800A	1	HI460I	102532

* includes bridging bars & external handle

Description	Pack Qty.	Cat. Ref.	Unit MRP (₹)
External handle			
for HI 125 to 630A	1	HZI002I	1480
for HI 800 to 1600A	1	HZI003I	3283
Shaft extension			
for HI 125 to 630A, 200mm	1	HZC101I	616
for HI 125 to 630A, 320mm	1	HZC102I	778
for HI 800 to 1600A, 200mm	1	HZC105I	1901
for HI 800 to 1600A, 320mm	1	HZC106I	2246
Terminal shrouds			
for HI 125 to 200A	1	HZC202I	1058
Top and bottom (2 pieces / packaging)			
for HI 200 to 400A	1	HZC204I	2344
for HI 400 to 630A	1	HZC206I	2765
Auxiliaries contacts			
for HI 125 to 1600A, 1NO + 1NC	1	HZ160I	1048
Terminal shield			
for HI460I	1	HZ163MI	#
Top and bottom			
for HI462I and HI464I	1	HZ164MI	#

- Prices available upon request

MCOS enclosures

Characteristics:

- Rating: 63 – 1600A
- Changeover: 4P type
- Door: Hinged type single door
- Mounting: Surface type
- Preassembled with Manual COS
- Padlocking facility
- Removable gland plate
- Gasket protection

Description	Pack Qty.	Rating	Cat. Ref.	Unit MRP (₹)
63A FP MCOS Hinged Door Box	1	63A	VYE63M	9876
100A FP MCOS Hinged Door Box	1	100A	VYE100M	13018
125A FP MCOS Hinged Door Box	1	125A	VYE125M	18702
160A FP MCOS Hinged Door Box	1	160A	VYE160M	20487
250A FP MCOS Hinged Door Box	1	250A	VYE250M	32137
400A FP MCOS Hinged Door Box	1	400A	VYE400M	49166
630A FP MCOS Hinged Door Box	1	630A	VYE630M	69084



HIB412I

Automatic transfer switches

Characteristics:

- Motorized changeover switches
- Rating 125 to 1600A
- Allows automated switch, changeover switch or on load power circuit permutation
- For safety breaking
- 4P version
- Padlocking in OFF position
- Mounting on plain or perforated plate
- Controller HZI815I controls HIB switches
- Comply with NF EN 60 947-3

Motorized changeover switches (In)

Description	Pack Qty.	Cat. Ref.	Unit MRP (₹)
125A	1	HIB412I	72792
160A	1	HIB416I	89300
250A	1	HIB425I	104933
400A	1	HIB440I	129179
630A	1	HIB463I	169495
800A	1	HIB480I	254523

- * includes bridging bars & external handle
- * controller to be ordered separately

Automatic Transfer Relays

Description	Pack Qty.	Cat. Ref.	Unit MRP (₹)
Controller	1	HZI815I	30866

Terminal shrouds top and bottom (2 pieces / packaging)

Description	Pack Qty.	Cat. Ref.	Unit MRP (₹)
for switches 125 to 160A	1	HZC202I	1058
for switches 200 to 400A	1	HZC204I	2344
for switches 400A to 630A	1	HZC206I	2765

Terminal covers

Description	Pack Qty.	Cat. Ref.	Unit MRP (₹)
for switches 125 to 160A	1	HZI201I	778
for switches 250 to 400A	1	HZI202I	1048
for switches 630A	1	HZI203I	1210
for switches 800 to 1250A	1	HZI204I	1393
for switches 1600A	1	HZI205I	1901

HZI815I must be ordered along with Motorized changeover for Auto transfer switch to function

- Prices available upon request



EKS306B

SPN - Automatic changeover and current limiter

Characteristics:

- IEC 60947 - 3, IEC 60947 - 6
- SPN Modular
- Voltage: 150VAC to 300VAC
- 6000 Operations

- Blinking LED for overload and permanent
- LED for overload Trip
- Different LED colors for clear differentiation between functions

Description	Pack Qty.	Cat. Ref.	Unit MRP (₹)
Mains 30A, Genset 1.5A	1	▶ EKS301B	3005
Mains 30A, Genset 2.5A	1	▶ EKS302B	3005
Mains 30A, Genset 3A	1	▶ EKS303B	3005
Mains 30A, Genset 4A	1	EKS304B	3005
Mains 30A, Genset 5A	1	▶ EKS305B	3005
Mains 30A, Genset 6A	1	▶ EKS306B	3005
Mains 30A, Genset 9A	1	▶ EKS309B	3005
Mains 30A, Genset 12A	1	EKS312B	3005
Mains 30A, Genset 15A	1	EKS315B	3005
Mains 30A, Genset 20A	1	▶ EKS320B	3005
Mains 30A, Genset 30A (without current limiting)	1	▶ EKS330B	3005



EKT406SG

TPN - Automatic Changeover and Current Limiter

Characteristics:

- IEC 60947 - 6
- TPN / TPN & TPN / SPN
- Voltage: 150VAC to 300VAC

- 10000 Operations
- Genset Start / Stop as standard

TPN / SPN

Description	Pack Qty.	Cat. Ref.	Unit MRP (₹)
Mains 40A, Genset 6A	1	EKT406SG	17114
Mains 40A, Genset 10A	1	EKT410SG	17114
Mains 40A, Genset 16A	1	EKT416SG	17114
Mains 40A, Genset 20A	1	EKT420SG	17114
Mains 40A, Genset 25A	1	EKT425SG	17114
Mains 40A, Genset 30A	1	EKT430SG	17114
Mains 63A, Genset 6A	1	EKT606SG	25270
Mains 63A, Genset 10A	1	EKT610SG	25270
Mains 63A, Genset 16A	1	EKT616SG	25270
Mains 63A, Genset 20A	1	EKT620SG	25270
Mains 63A, Genset 25A	1	EKT625SG	25270
Mains 63A, Genset 30A	1	EKT630SG	25270
Mains 63A, Genset 40A	1	EKT640SG	25270

TPN / TPN

Description	Pack Qty.	Cat. Ref.	Unit MRP (₹)
Mains 40A, Genset 6A	1	EKT406TG	17930
Mains 40A, Genset 10A	1	EKT410TG	17930
Mains 40A, Genset 16A	1	EKT416TG	17930
Mains 40A, Genset 20A	1	EKT420TG	17930
Mains 40A, Genset 25A	1	EKT425TG	17930
Mains 40A, Genset 30A	1	EKT430TG	17930
Mains 63A, Genset 6A	1	EKT606TG	26076
Mains 63A, Genset 10A	1	EKT610TG	26076
Mains 63A, Genset 16A	1	EKT616TG	26076
Mains 63A, Genset 20A	1	EKT620TG	26076
Mains 63A, Genset 25A	1	EKT625TG	26076
Mains 63A, Genset 30A	1	EKT630TG	26076
Mains 63A, Genset 40A	1	EKT640TG	26076

TPN / TPN

(without current limiting)

Description	Pack Qty.	Cat. Ref.	Unit MRP (₹)
Mains 40A, Genset 40A	1	EKT440TG	17930
Mains 63A, Genset 63A	1	EKT663TG	43190

*80/80A and 100/100A ACCL also available upon request



NCN106N



NCN206N



NCN306N



NCN406N

Miniature circuit breakers - type NBN---N, NCN---N

Characteristics:

- Conforms to IS/IEC 60898 - 1: IEC 60898
- Curve B & C
- 2P Suitable for 1P+N application; 4P Suitable for TP +N application
- 10 kA as per IEC 60898
- ISI Marked

Description	Pack Qty.	Cat. Ref. Curve B	Unit MRP (₹)	Cat. Ref. Curve C	Unit MRP (₹)
Single Pole					
0.5A, 1 module	12	-	-	NCN100N	717
1A, 1 module	12	-	-	NCN101N	717
2A, 1 module	12	-	-	NCN102N	717
3A, 1 module	12	-	-	NCN103N	717
4A, 1 module	12	-	-	NCN104N	717
6A, 1 module	12	NBN106N	459	NCN106N	448
10A, 1 module	12	NBN110N	459	NCN110N	448
16A, 1 module	12	NBN116N	459	NCN116N	448
20A, 1 module	12	NBN120N	459	NCN120N	448
25A, 1 module	12	NBN125N	459	NCN125N	448
32A, 1 module	12	NBN132N	459	NCN132N	448
40A, 1 module	12	NBN140N	997	NCN140N	1019
50A, 1 module	12	NBN150N	997	NCN150N	1019
63A, 1 module	12	NBN163N	997	NCN163N	1019
Double Pole (Suitable for 1P+N application)					
0.5A, 2 module	6	-	-	NCN200N	2052
1A, 2 module	6	-	-	NCN201N	2052
2A, 2 module	6	-	-	NCN202N	2052
3A, 2 module	6	-	-	NCN203N	2052
4A, 2 module	6	-	-	NCN204N	2052
6A, 2 module	6	NBN206N	1436	NCN206N	1516
10A, 2 module	6	NBN210N	1436	NCN210N	1516
16A, 2 module	6	NBN216N	1436	NCN216N	1516
20A, 2 module	6	NBN220N	1436	NCN220N	1516
25A, 2 module	6	NBN225N	1436	NCN225N	1516
32A, 2 module	6	NBN232N	1436	NCN232N	1516
40A, 2 module	6	NBN240N	2303	NCN240N	2394
50A, 2 module	6	NBN250N	2303	NCN250N	2394
63A, 2 module	6	NBN263N	2303	NCN263N	2394
Triple Pole					
0.5A, 3 modules	4	-	-	NCN300N	3032
1A, 3 modules	4	-	-	NCN301N	3032
2A, 3 modules	4	-	-	NCN302N	3032
3A, 3 modules	4	-	-	NCN303N	3032
4A, 3 modules	4	-	-	NCN304N	3032
6A, 3 modules	4	NBN306N	2440	NCN306N	2428
10A, 3 modules	4	NBN310N	2440	NCN310N	2428
16A, 3 modules	4	NBN316N	2440	NCN316N	2428
20A, 3 modules	4	NBN320N	2440	NCN320N	2428
25A, 3 modules	4	NBN325N	2440	NCN325N	2428
32A, 3 modules	4	NBN332N	2440	NCN332N	2428
40A, 3 modules	4	NBN340N	3682	NCN340N	3694
50A, 3 modules	4	NBN350N	3682	NCN350N	3694
63A, 3 modules	4	NBN363N	3682	NCN363N	3694
Four Pole (Suitable for 3P+N application)					
0.5A, 4 modules	3	-	-	NCN400N	3773
1A, 4 modules	3	-	-	NCN401N	3773
2A, 4 modules	3	-	-	NCN402N	3773
3A, 4 modules	3	-	-	NCN403N	3773
4A, 4 modules	3	-	-	NCN404N	3773
6A, 4 modules	3	NBN406N	3135	NCN406N	3295
10A, 4 modules	3	NBN410N	3135	NCN410N	3295
16A, 4 modules	3	NBN416N	3135	NCN416N	3295
20A, 4 modules	3	NBN420N	3135	NCN420N	3295
25A, 4 modules	3	NBN425N	3135	NCN425N	3295
32A, 4 modules	3	NBN432N	3135	NCN432N	3295
40A, 4 modules	3	NBN440N	4514	NCN440N	4697
50A, 4 modules	3	NBN450N	4514	NCN450N	4697
63A, 4 modules	3	NBN463N	4514	NCN463N	4697



NDN106N



NDN206N



NDN306N



NDN406N

Miniature circuit breakers - type NDN---N

Characteristics:

- Conforms to IS/IEC 60898 - 1: IEC 60898
- Curve D

- 10 kA as per IEC 60898
- ISI Marked

Description	Pack Qty.	Cat. Ref. Curve D	Unit MRP (₹)
Single Pole			
0.5A, 1 module	12	NDN100N	728
1A, 1 module	12	NDN101N	728
2A, 1 module	12	NDN102N	728
3A, 1 module	12	NDN103N	728
4A, 1 module	12	NDN104N	728
6A, 1 module	12	NDN106N	627
10A, 1 module	12	NDN110N	627
16A, 1 module	12	NDN116N	627
20A, 1 module	12	NDN120N	627
25A, 1 module	12	NDN125N	627
32A, 1 module	12	NDN132N	627
40A, 1 module	12	NDN140N	1120
50A, 1 module	12	NDN150N	1120
63A, 1 module	12	NDN163N	1120
Double Pole (Suitable for 1P+N application)			
0.5A, 2 modules	6	NDN200N	2086
1A, 2 modules	6	NDN201N	2086
2A, 2 modules	6	NDN202N	2086
3A, 2 modules	6	NDN203N	2086
4A, 2 modules	6	NDN204N	2086
6A, 2 modules	6	NDN206N	1550
10A, 2 modules	6	NDN210N	1550
16A, 2 modules	6	NDN216N	1550
20A, 2 modules	6	NDN220N	1550
25A, 2 modules	6	NDN225N	1550
32A, 2 modules	6	NDN232N	1550
40A, 2 modules	6	NDN240N	2554
50A, 2 modules	6	NDN250N	2554
63A, 2 modules	6	NDN263N	2554
Triple Pole			
0.5A, 3 modules	4	NDN300N	3124
1 A, 3 modules	4	NDN301N	3124
2A, 3 modules	4	NDN302N	3124
3A, 3 modules	4	NDN303N	3124
4A, 3 modules	4	NDN304N	3124
6A, 3 modules	4	NDN306N	2519
10A, 3 modules	4	NDN310N	2519
16A, 3 modules	4	NDN316N	2519
20A, 3 modules	4	NDN320N	2519
25A, 3 modules	4	NDN325N	2519
32A, 3 modules	4	NDN332N	2519
40A, 3 modules	4	NDN340N	3853
50A, 3 modules	4	NDN350N	3853
63A, 3 modules	4	NDN363N	3853
Four Pole (Suitable for 3P+N application)			
05A, 4 modules	3	NDN400N	3842
1A, 4 modules	3	NDN401N	3842
2A, 4 modules	3	NDN402N	3842
3A, 4 modules	3	NDN403N	3842
4A, 4 modules	3	NDN404N	3842
6A, 4 modules	3	NDN406N	3340
10A, 4 modules	3	NDN410N	3340
16A, 4 modules	3	NDN416N	3340
20A, 4 modules	3	NDN420N	3340
25A, 4 modules	3	NDN425N	3340
32A, 4 modules	3	NDN432N	3340
40A, 4 modules	3	NDN440N	4982
50A, 4 modules	3	NDN450N	4982
63A, 4 modules	3	NDN463N	4982



MZ215

Accessories for MCBs, RCCBs & RCBOs

Description	Pack Qty.	Cat. Ref.	Unit MRP (₹)
Auxiliary contact (1NO + 1NC), 0.5 module (For MCBs only)	1	MZ201	1781
Trip alarm contact (1NO + 1NC), 0.5 module (For MCBs only)	1	MZ202	2106
Shunt trip 230V AC, 1 module	1	MZ203	5141
Undervoltage release, 230V AC, 1 module	1	MZ206	4402
MCB Locking kit	2	MZN175	1019
Auxiliary + alarm switch (for RCCB), 1 module	1	CZ001	3371
Overvoltage release, 230V AC, $U_c > 280V$, 1 module	1	MZ209	5186
Overvoltage + Low voltage release, 230V AC, $60V AC < U < 170V AC$, $U > 267V AC$, 1 module	1	MZ215	6989
Overvoltage release, 230V AC, $U > 275 V AC$, 3 phase in 1 module Suitable for 3Ph+N	1	MZ216	9341

Use of MZ203/204/205/206/209/215/216 on RCCBs require use of interface auxiliary CZ001



CD240Y

RCCBs

Characteristics:

- Conforms to IEC 61008
- IS12640-1
- ISI Marked

- Protects a circuit automatically in the event of an earth leakage
- With earth fault indicator & positive contact indication

Description	Pack Qty.	Sensitivity	Cat. Ref.	Unit MRP (₹)
Double Pole				
16A, 2 modules	1	10 mA	CC216Y	11856
25A, 2 modules	1	10 mA	CC225Y	13600
	1	30 mA	CD225Y	5027
	1	100 mA	CE225Y	5632
	1	300 mA	CF225Y	5654
40A, 2 modules	1	30 mA	CD240Y	5882
	1	100 mA	CE240Y	6350
	1	300 mA	CF240Y	6555
63A, 2 modules	1	30 mA	CD263Y	7114
	1	100 mA	CE263Y	7684
	1	300 mA	CF263Y	7741
100A, 2 modules	1	30 mA	CDC284Y	19334
	1	300 mA	CEC284Y	19334



CD440Y

Four Pole

25A, 4 modules	1	30 mA	CD425Y	7102
	1	100 mA	CE425Y	7399
	1	300 mA	CF425Y	7547
40A, 4 modules	1	30 mA	CD440Y	6954
	1	100 mA	CE440Y	7444
	1	300 mA	CF440Y	7684
63A, 4 modules	1	30 mA	CD463Y	7877
	1	100 mA	CE463Y	8869
	1	300 mA	CF463Y	8869
100A, 4 modules	1	30 mA	CDC484Y	19517
	1	100 mA	CEC484Y	19517
	1	300 mA	CFC484Y	19825

RCCBs - type Hi (high immunity)

Characteristics:

- Conforms to IEC 61008 & EMC standard EN 61543
- For electrical networks with high harmonics / pulsated DC currents and transients

- With earth fault indicator & positive contact indication



CH240J

Description	Pack Qty.	Sensitivity	Cat. Ref.	Unit MRP (₹)
Double Pole				
25A, 2 modules	1	30 mA	CH225J	10841
	1	300 mA	CQ225J	10442
40A, 2 modules	1	30 mA	CH240J	11286
	1	300 mA	CQ240J	10807
63A, 2 modules	1	30 mA	CH263J	11617
	1	300 mA	CQ263J	11377



CH440J

Four Pole

25A, 4 modules	1	300 mA	CQ425J	11605
40A, 4 modules	1	30 mA	CH440J	12608
	1	300 mA	CQ440J	12095
63A, 4 modules	1	30 mA	CH463J	12825
	1	300 mA	CQ463J	12472



AD956Y

RCBOs - 2 pole 2 modules

Characteristics:

- Conforms to IEC 61009
- Breaking capacity 6kA

- Two pole compact device for overload, short-circuit and
- earth leakage protection, with earth fault indicator

Description	Pack Qty.	Sensitivity	Cat. Ref.	Unit MRP (₹)
Double Pole				
6A, 2 modules	1	30 mA	AD956Y	7604
	1	100mA	AE956Y	7763
10A, 2 modules	1	30 mA	AD960Y	7604
	1	100mA	AE960Y	7763
16A, 2 modules	1	30 mA	AD966Y	7604
	1	100 mA	AE966Y	7763
	1	300 mA	AF966Y	8048
20A, 2 modules	1	30 mA	AD970Y	7604
	1	100 mA	AE970Y	7763
	1	300 mA	AF970Y	8048
25A, 2 modules	1	30 mA	AD975Y	7604
	1	100mA	AE975Y	7763
	1	300 mA	AF975Y	8048
32A, 2 modules	1	30 mA	AD982Y	8003
	1	100mA	AE982Y	7980
	1	300 mA	AF982Y	8470
40A, 2 modules	1	30 mA	AD990Y	9485
	1	100mA	AE990Y	9701
	1	300 mA	AF990Y	9542



ADH975

RCBOs - type Hi (high immunity)

Characteristics:

- Conforms to IEC 61009
- Breaking capacity 6kA

- For electrical networks with high harmonics / pulsated
- DC components with earth fault indicator

Description	Pack Qty.	Sensitivity	Cat. Ref.	Unit MRP (₹)
Double Pole				
16A, 2 modules	1	30 mA	ADH966	13760
	1	300 mA	AFH966	14558
20A, 2 modules	1	30 mA	ADH970	13760
25A, 2 modules	1	30 mA	ADH975	13760
	1	300 mA	AFH975	14558
32A, 2 modules	1	30 mA	ADH982	15584
40A, 2 modules	1	30 mA	ADH990	18388

Protection devices

RCBO, RCD+MCB modules



ADC225Y

RCBO, RCD+MCB modules

Characteristics:

- Conforms to IEC 61009-1
- Breaking capacity 10kA
- CE / ISI Marked
- RoHS compliant
- Type AC
- Two pole and four pole device for overload, short-circuit and earth leakage protection, with earth fault indicator

Description	Pack Qty.	Sensitivity	Cat. Ref.	Unit MRP (₹)
Double Pole				
6A, 4 modules	1	30 mA	ADC206Y	6202
	1	100 mA	AEC206Y	7718
10A, 4 modules	1	30 mA	ADC210Y	6430
	1	100 mA	AEC210Y	7718
16A, 4 modules	1	30 mA	ADC216Y	5939
	1	100 mA	AEC216Y	7421
	1	300 mA	AFC216Y	7672
25A, 4 modules	1	30 mA	ADC225Y	6122
	1	100 mA	AEC225Y	7786
	1	300 mA	AFC225Y	8208
32A, 4 modules	1	30 mA	ADC232Y	6498
	1	100 mA	AEC232Y	7604
	1	300 mA	AFC232Y	7934
40A, 4 modules	1	30 mA	ADC240Y	7729
	1	100 mA	AEC240Y	8550
	1	300 mA	AFC240Y	8789
63A, 4 modules	1	30 mA	ADC263Y	9884
	1	100 mA	AEC263Y	10579
	1	300 mA	AFC263Y	10750



ADC425Y

Four Pole

16A, 6 modules	1	30 mA	ADC416Y	8368
	1	100 mA	AEC416Y	9428
	1	300 mA	AFC416Y	9724
25A, 6 modules	1	30 mA	ADC425Y	8949
	1	100 mA	AEC425Y	9656
	1	300 mA	AFC425Y	10032
32A, 7 modules	1	30 mA	ADC432Y	8630
	1	100 mA	AEC432Y	9416
	1	300 mA	AFC432Y	9701
40A, 7 modules	1	30 mA	ADC440Y	8755
	1	100 mA	AEC440Y	9542
	1	300 mA	AFC440Y	9576
63A, 7 modules	1	30 mA	ADC463Y	10784
	1	100 mA	AEC463Y	11354
	1	300 mA	AFC463Y	11560



LS501

HRC fuse carriers

Characteristics:

- Conforms to IEC 60269 - 2
- IEC 60269 - 2 - 1
- IEC 60947 - 3
- Description
- Protection and control of circuits against overloads and short circuits.
- Technical data
- sizes : L38, L51
- poles : 1P, 2P
- voltage rating : 500 V AC, 690V AC
- current rating : 32 to 50A
- frequency : 50/60Hz
- climate sealed : T2
- short circuit resistance with fuse link 10.3 x 38 mm :
 - 80kA – 690V~ /
 - 120kA – 500 V~
- short circuit resistance with fuse link 14x51 mm :
 - 100kA – 690V
- Connection capacity
- L38 (10x38) :
 - rigid conductors : 25mm²
 - flexible conductors : 16mm²
- L51 (14x51) :
 - rigid conductors : 35mm²
 - flexible conductors : 25mm²

Description	Pack Qty.	Characteristics	Cat. Ref.	Unit MRP (₹)
L38 fuse carriers 690V - 32A	12	Single Pole	LSN501	475
L51 fuse carriers 690V - 32A	1	Single Pole	LS601	1739
	1	Double Pole	LS602	3596



LF302G

HRC cartridge fuses - gG type

Description	Pack Qty.	Characteristics	Amp Rating	Cat. Ref.	Unit MRP (₹)
Cartridge fuses					
type gG	10	500 V AC	1A	LF301G	97
10 x 38 mm	10		2A	LF302G	97
breaking capacity: 120kA	10		4A	LF304G	97
	10		6A	LF306G	97
	10		10A	LF310G	97
	10		12A	LF312G	97
	10		16A	LF316G	97
	10		20A	LF320G	97
	10		25A	LF325G	97
	10	400 V AC	32A	LF332G	108
Cartridge fuses					
type gG	10	690 V AC	6A	LF406G	184
14 x 51 mm					
breaking capacity:	10	500 V AC	32A	LF432G	184
2 to 25A : 80kA	10		40A	LF440G	184
32 to 50A : 120kA	10	400 V AC	50A	LF450G	238



SPL465R

Surge protection devices

Characteristics:

- Conforms to IEC 61643 - 1
- IEC 61643 - 11

- Protects electronic equipments against transient voltage surges caused by lightning or switching of motors, transformers etc.

Description	Pack Qty.	Characteristics	Cat. Ref.	Unit MRP (₹)
Type 1 + 2 products-main protection				
Imax 12.5kA (Remote Signaling)	1	2P T1+T2 TNS/TT	SPL212R	18481
Imax 12.5kA (Remote Signaling)	1	4P T1+T2 TNS/TT	SPL412R	36996
Type 2 products-main protection				
Imax 20kA	1	2P T2 TNS/TT	SPL220	10247
Imax 20kA	1	4P T2 TNS/TT	SPL420	19481
Imax 40kA	1	2P T2 TNS/TT	SPL240	12087
Imax 40kA	1	4P T2 TNS/TT	SPL440	23736
Imax 65kA (Remote Signaling)	1	2P T2 TNS/TT	SPL265R	20666
Imax 65kA (Remote Signaling)	1	4P T2 TNS/TT	SPL465R	41032
Phase cartridges for				
	1	SPL220/SPL420	SPL020	3324
	1	SPL240/SPL440	SPL040	4083
	1	SPL265R/SPL465R	SPL065	4876
Neutral cartridges for				
	1	SPL240/SPL440	SPL040N	6509



SFT240N

2 way centre off changeover switches

Characteristics:

- Allows changeover from electricity boards supply to generator supply & vice-versa

Description	Pack Qty.	Cat. Ref.	Unit MRP (₹)
Double Pole			
25A, 2 modules	1	SFT225N	3456
40A, 2 modules	1	SFT240N	5270
63A, 4 modules		SF263	5594
Four Pole			
40A, 4 modules	1	SFT440N	8489
63A, 8 modules	1	SF463	9331



SBN225N

Isolating switches

Characteristics:

- Conforms to IEC 60947-III

- AC22A devices used as switch disconnectors in electrical circuit

Double Pole	Pack Qty.	Cat. Ref. Curve C	Unit MRP (₹)
40A, 2 modules	1	SBN240N	863
63A, 2 modules	1	SBN263N	1150
100A, 2 modules	1	SBN290N	1645

Triple Pole

40A, 3 modules	1	SBN340N	1576
63A, 3 modules	1	SBN363N	1840
100A, 3 modules	1	SBN390N	2197

Four Pole

63A, 4 modules	1	SBN463N	2151
100A, 4 modules	1	SBN490N	2691



SBN440N



MFM Characteristics :

Password Protection
Class 0.5 Accuracy
31st order THD (available in Power Analyzer)
Backlight LCD display
Demand Controller with Contact
RS485 communication

Description	Pack Qty.	Cat.Ref.	Unit MRP(₹)
Single Phase Ammeter LED	1	SMHMA7001EWH	1,160
Single Phase Volt Meter LED	1	SMHMV7001EWH	1,160
Three Phase Amp Meter LED	1	SMHMA7003EWH	1,900
Three Phase Volt Meter LED	1	SMHMV7003EWH	1,900
VAF Meter LED	1	SMHME8003EWM	2,380
Energy MFM LED + RS485	1	SMHME8003EWH	6,500
Energy MFM LCD + RS485	1	SMHME8003CWH	6,500
Power analyser Dual Source LCD+ RS485	1	SMHMP9003EWH	10,000
Power analyser Dual Source LCD+ RS485	1	SMHMP9003CWH	11,250

Voltage protection relay Characteristics:

Under voltage/Over voltage/phase reversal Protection
Fault and Healthiness Annunciation
3P/3W and 3P/4W versions
Potential Free Contact for CB operation
Din rail Mounting
Demand Controller with Contact
RS485 communication



Description	Pack Qty.	Cat.Ref.	Unit MRP(₹)
CT 25/5A CL1	1	SRHCX0025BHM	620
CT 50/5A CL1	1	SRHCX0050BHM	620
CT 75/5A CL1	1	SRHCX0075BHM	620
CT 100/5A CL1	1	SRHCX0100BHM	620
CT 150/5A CL1	1	SRHCX0150BHM	600
CT 200/5A CL1	1	SRHCX0200BHM	600
CT 250/5A CL1	1	SRHCX0250BHM	600
CT 300/5A CL1	1	SRHCX0300BHM	680
CT 400/5A CL1	1	SRHCX0400BHM	680
CT 450/5A CL1	1	SRHCX0450BHM	720
CT 500/5A CL1	1	SRHCX0500BHM	720
CT 600/5A CL1	1	SRHCX0600BHM	720
CT 800/5A CL1	1	SRHCX0800BHM	950
CT 1000/5A CL1	1	SRHCX1000BHM	1,040
CT 1250/5A CL1	1	SRHCX1250BHM	1,210
CT 1600/5A CL1	1	SRHCX1600BHM	1,300
CT 2000/5A CL1	1	SRHCX2000BHM	1,300
CT 2500/5A CL1	1	SRHCX2500BHM	1,620
CT 3000/5A CL1	1	SRHCX3000BHM	1,750
CT 4000/5A CL1	1	SRHCX4000BHM	2,110

Timer Characteristics:

Use settable Delay for Suitable Automation
Relay and Power operation annunciation through LED
High operational endurance
Din rail Mounting



Description	Pack Qty.	Cat.Ref.	Unit MRP(₹)
VOLTAGE PROTECTION RELAY 3P/3W	1	EUHRVP33D	1,990
VOLTAGE PROTECTION RELAY 3P/4W	1	EUHRVP34D	1,990
Timer STAR DELTA	1	EZHSD00D	1,880
Timer MULTIFUNCTION	1	EZHMF00D	1,960
Timer CYCLIC	1	EZHCY00D	1,960
Timer ON DELAY	1	EZHOD00D	990

Indicator lights	72
Push buttons	72
Modular contactors	72
Movement & presence detectors	72
Movement detector-wall mounted	72
Accessories for movement & presence detectors	72



SVN126

Indicating lights (LED)

Characteristics:

- Modular LED indicating lights for remote signalling of status of an electrical circuit

Description	Pack Qty.	Cat. Ref.	Unit MRP (₹)
Green, 1 module	12	SVN121	1199
Red+Green indicator, 1 module	12	SVN126	1544
Red+Orange+Blue (RYB) indicator, 1 module	12	SVN222	2246



SVN312

Contactors

Characteristics:

- All contactor ratings are for AC 7A load only (Coil voltage 230V 50Hz)

- For remote switching & control of power circuits

Description	Pack Qty.	Cat. Ref.	Unit MRP (₹)
Type 1 products-main protection			
2 NO, 25A, 1 module	1	ESC225	3164
1 NO+1NC, 25A, 1 module	1	ESC227	3510
2 NO, 40A, 3 modules	1	ESC240	5616
2 NO, 63A, 3 modules	1	ESC263	7657
3 NO, 40A, 3 modules	1	ESC340	7679
3 NO, 63A 3 modules	1	ESC363	9947
4 NO, 25A, 3 modules	1	ESC425	5033
4 NO, 40A, 3 modules	1	ESC440	9061
3 NO+1NC, 40A, 3 modules	1	ESC443	8197
4 NO, 63A, 3 modules	1	ESC463	11005
2NO+2NC, 63A, 3 modules	1	ESC465	9839
Auxiliary contact 1NO+1NC	1	ESC080	3067



ESC463

Detection Solutions



EE805A

Movement and presence detectors

Characteristics:

- Day light sensing.
- Surface and flush mounting versions
- Adjustable time delay and lux level settings
- Movement detectors
- - Inbuilt ambient light sensor with adjustable lux level 5 to 1000 lux
- - adjustable time delay upto 30 mins

Description	Pack Qty.	Cat. Ref.	Unit MRP (₹)
Single lens, 360°, 6m dia detection 10A AC 1, 1 channel, surface mounted	1	EE804A	5275
Single lens, 360°, 6m dia detection 10A AC 1, 1 channel, flush mounted	1	EE805A	5275

Zero-crossing contact PIR Presence/motion detector

Characteristics

Zero-crossing contact
PIR Presence/motion detector



EER501

Description	Pack Qty.	Cat.Ref.	Unit MRP(₹)
Single lens, 360°, 20m detection 10A AC 1,1 channel, flush mount mounted	1	EER501	10270



EER505

Single lens, 360°, 20m dia detection 10A AC 1,1 channel, flush mounted	1	EER503	11230
Single lens, 360°, 30x5m detection 10A AC 1,1 channel, flush mounted.	1	EER505	11185



EER513

Single lens, 360°, 20m dia detection 10A AC 1, 1 channel, surface mounted	1	EER513	11230
Single lens, 360°, 10A AC 1, 1 channel, surface mounted for Corridor	1	EER515	11185
Single lens, 360°, 10A AC 1, 1 channel, surface mounted for HighBay	1	EER518	12690

Wiring Accessories

insysta range of wiring accessories is tailor made to suit the requirement of Indian customers. The comprehensive range offers “AX” rated switches to switch inductive loads without derating the switches. insysta switches can be front loaded & removed, thus giving easy access when maintenance is required. The sockets & fan regulators are tested & conform to ISI standards and is marked giving utmost confidence to the users.

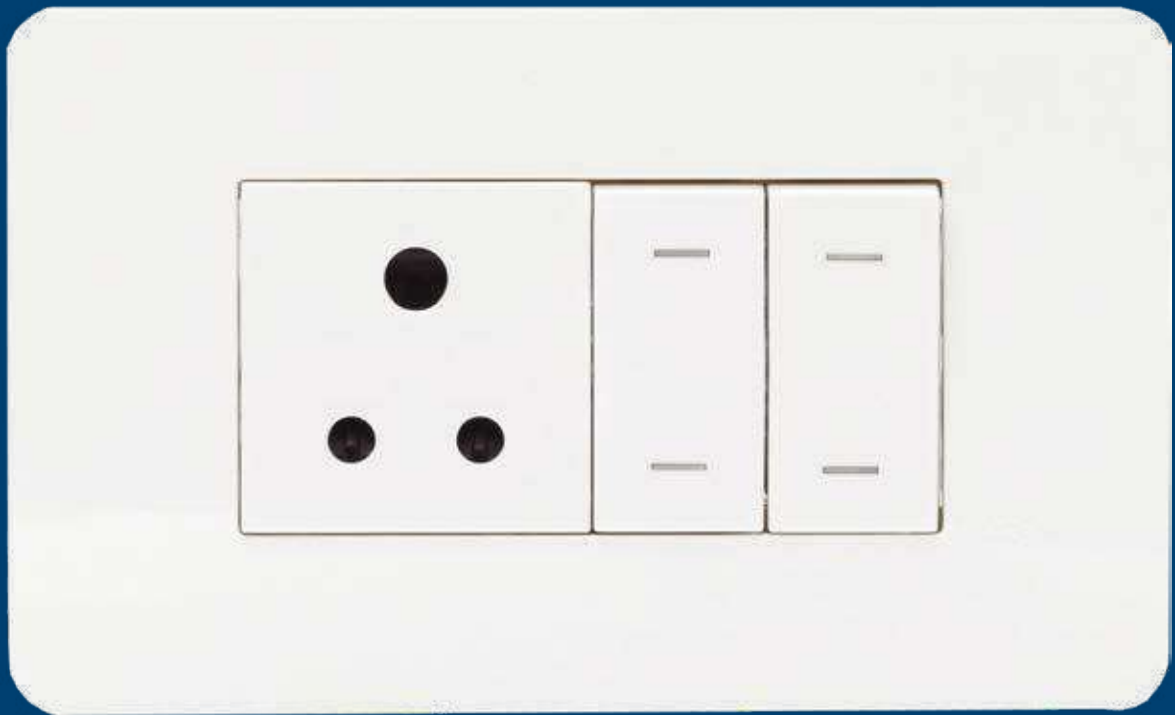

6AX switches	78
10AX switches	78
16AX switches	78
20AX switches	78
20A / 32A Double Pole switches	78
Push button	79
Sockets	79
Regulators & dimmers	79
Data sockets	80
VDI module & accessories	80
USB socket	80
Cover & grid plates - Plastic	80
Cover plates - Real material	80
Grid plates - Real material	80
Wall Boxes	80

insysta™ 6AX switches



WSNSW11

Description	Module size	Cat. Ref.	Unit MRP (₹)
1 way glossy white	1	WSNSW11	194
1 way glossy white with LED	1	WSNSL11	308
1 way anthracite	1	WSNSW11A	239
1 way anthracite with LED	1	WSNSL11A	376
2 way glossy white	1	WSNSW21	285
2 way anthracite	1	WSNSW21A	331

insysta™ 10AX switches



WSNSW31

Description	Module size	Cat. Ref.	Unit MRP (₹)
1 way glossy white	1	WSNSW31	251
1 way anthracite	1	WSNSW31A	296

insysta™ 16AX switches



WSNSW61

Description	Module size	Cat. Ref.	Unit MRP (₹)
1 way glossy white	1	WSNSW51	376
1 way glossy white with LED	1	WSNSL51	353
1 way anthracite	1	WSNSW51A	399
1 way anthracite with LED	1	WSNSL51A	433
2 way glossy white	1	WSNSW61	399
2 way anthracite	1	WSNSW61A	479

insysta™ 20AX switches



WSNSL71

Description	Module size	Cat. Ref.	Unit MRP (₹)
1 way glossy white	1	WSNSW71	365
1 way glossy white with LED	1	WSNSL71	388
1 way anthracite	1	WSNSW71A	433
1 way anthracite with LED	1	WSNSL71A	456

insysta™ 20A / 32A Double Pole switches with LED



WSNSW81

Description	Module size	Cat. Ref.	Unit MRP (₹)
20A DP 1 way glossy white	2	WSNSW81	787
20A DP 1 way anthracite	2	WSNSW81A	946
32A DP 1 way glossy white	2	WSNSL92	1117
32A DP 1 way anthracite	2	WSNSL92A	1345

insysta™ Push button



WSNBP11

Description	Module size	Cat. Ref.	Unit MRP (₹)
6A glossy white	1	WSNBP11	285
6A glossy white with Indicator	1	WSNBP21	388
6A glossy white	2	WSNBP12	410
6A glossy white with Indicator	2	WSNBP22	502
6A anthracite	1	WSNBP11A	342
6A anthracite with Indicator	1	WSNBP21A	456
6A anthracite	2	WSNBP12A	502
6A anthracite with Indicator	2	WSNBP22A	604

insysta™ Sockets



WSNSK42

Description	Module size	Cat. Ref.	Unit MRP (₹)
6 / 16A glossy white Protruded	2	WSNSK42	479
6 / 16A glossy white	3	WSNSK53	581
6 / 16A anthracite Protruded	2	WSNSK42A	581
6 / 16A anthracite	3	WSNSK53A	718
6A Indian socket glossy white	2	WSNSK72	342
6A Indian socket anthracite	2	WSNSK72A	467

insysta™ Regulators & dimmers



WSNFC22

Description	Module size	Cat. Ref.	Unit MRP (₹)
100W glossy white fan regulator	1	WSNFC11	992
120W glossy white fan regulator	2	WSNFC22	1334
400W glossy white incandescent rotary dimmer	1	WSNDM11	1208
1000W glossy white incandescent rotary dimmer	2	WSNDM22	2394
100W anthracite fan regulator	1	WSNFC11A	1163
120W anthracite fan regulator	2	WSNFC22A	1585
400W anthracite incandescent rotary dimmer	1	WSNDM11A	1436
1000W anthracite incandescent rotary dimmer	2	WSNDM22A	2873

insysta™ Data sockets



WSNDS11

Description	Module size	Cat. Ref.	Unit MRP (₹)
glossy white RJ11 single	1	WSNDS11	308
glossy white RJ11 twin	1	WSNDS21	433
glossy white RJ45 cat 5e	1	WSNDS31	787
glossy white RJ45 cat 6	1	WSNDS41	912
anthracite RJ11 single	1	WSNDS11A	388
anthracite RJ11 twin	1	WSNDS21A	513
anthracite RJ45 cat 5e	1	WSNDS31A	946
anthracite RJ45 cat 6	1	WSNDS41A	1094

insysta™ VDI module & accessories



WSNDT11



WSNDT31

Description	Module size	Cat. Ref.	Unit MRP (₹)
glossy white HDMI Port	1	WSNDT21	2269
glossy white 3x female RCA AV Connector	1	WSNDT31	3055
glossy white female HD VGA 15AV Connector	1	WSNDT42	3933
glossy white Co-Axial TV socket	1	WSNDT11	251
glossy white cord outlet	1	WSNDS71	342
glossy white blanking plate	1	WSNBK11	57
anthracite HDMI Port	1	WSNDT21A	2725
anthracite 3x female RCA AV Connector	1	WSNDT31A	3591
anthracite female HD VGA 15AV Connector	1	WSNDT42A	4640
anthracite Co-Axial TV socket	1	WSNDT11A	308
anthracite cord outlet	1	WSNDS71A	410
anthracite blanking plate	1	WSNBK11A	68



WSNDS51

insysta™ USB sockets

Description	Module size	Cat. Ref.	Unit MRP (₹)
glossy white USB Port	1	WSNDS51	1824
anthracite USB Port	1	WSNDS51A	2177
2A glossy white USB charger	1	WSNDS61	3238
2A anthracite USB charger	1	WSNDS61A	3682

- For charging purpose please select USB charger. USB ports to be used for data transfer.



WSNCG1

insysta™ Cover plates - Plastic

Pack qty.	Module size	Glossy white		Anthracite (Dark Gray)	
		Cat. Ref.	Unit MRP (₹)	Cat. Ref.	Unit MRP (₹)
15	1	WSNCG1	190	WSNCG1A	336
15	2	WSNCG2	190	WSNCG2A	358
10	3	WSNCG3	224	WSNCG3A	381
10	4	WSNCG4	224	WSNCG4A	437
5	6	WSNCG6	426	WSNCG6A	728
5	8	WSNCG8	504	WSNCG8A	806
5	8	WSNCGS8	594	WSNCGS8A	1053
5	12	WSNCG12	750	WSNCG12A	1366
5	18	WSNCG18	1019	WSNCG18A	1803



WSNCG1GW

insysta™ Cover plates - Real material

Pack qty.	Module size	White glass		Black glass	
		Cat. Ref.	Unit MRP (₹)	Cat. Ref.	Unit MRP (₹)
1	1	WSNCG1GW	2405	WSNCG1GB	2485
1	2	WSNCG2GW	2713	WSNCG2GB	2782
1	3	WSNCG3GW	3443	WSNCG3GB	3511
1	4	WSNCG4GW	3545	WSNCG4GB	3614
1	6	WSNCG6GW	4970	WSNCG6GB	5050
1	8	WSNCG8GW	5951	WSNCG8GB	5860
1	8	WSNCGS8GW	5939	WSNCGS8GB	6008
1	12	WSNCG12GW	6703	WSNCG12GB	6783



WSNG3

insysta™ Grid plates - Real material

Description	Pack qty.	Module size	Cat. Ref.	Unit MRP (₹)
Grid Plate - 1 module	1	1	WSNG1	114
Grid Plate - 2 module	1	2	WSNG2	114
Grid Plate - 3 module	1	3	WSNG3	125
Grid Plate - 4 module	1	4	WSNG4	171
Grid Plate - 6 module	1	6	WSNG6	239
Grid Plate - 8 module (Horizontal)	1	8	WSNG8	285
Grid Plate - 8 module (Square)	1	8	WSNG8S	308
Grid Plate - 12 module	1	12	WSNG12	433



WSNMB3

insysta™ Wall boxes

Description	Pack qty.	Module size	Cat. Ref.	Unit MRP (₹)
Metal Mounting Boxes 1 & 2	60	2	WSNMB2	146
Metal Mounting Boxes 3 module	45	3	WSNMB3	146
Metal Mounting Boxes 4 module	30	4	WSNMB4	190
Metal Mounting Boxes 6 module	20	6	WSNMB6	291
Metal Mounting Boxes 8 module (Horizontal)	15	8	WSNMB8H	347
Metal Mounting Boxes 8 module (Square)	24	8	WSNMB8R	347
Metal Mounting Boxes 12 module	16	12	WSNMB12	526
Metal Mounting Boxes 18 module	10	18	WSNMB18	661

Dispatch lead time for non-stockable references:

- MCBs / RCCBs / RCBOs - 2 weeks
- novello⁺ distribution boards - 4 - 6 weeks
- golf, vector enclosures & MCCBs - 8 weeks
- Manual changeover switches - 4 - 6 weeks
- Automatic transfer switches - 6 - 8 weeks
- Others - 4 - 6 weeks
- The above delivery lead times are subject to change without prior notice. Please contact your nearest Sales representative / Office for latest delivery lead times.

Terms & Conditions

- Price means Maximum Retail Price (M.R.P).
- This price list supercedes all previous price list.
- Price is in Indian Rupees (₹) and inclusive of GST / taxes / duties as applicable.
- Delivery term is "Door Delivery".
- Prices are subject to revision without notice. All dispatch will be as per price prevailing on the date of invoice.
- Enclosures / Distribution Boards have the provision for fixing the component as shown in the photograph.
- For all Insysta Color reference and real material, minimum ordering quantity will be applicable. Please connect with sales representative for details regarding MOQ.
- All the products listed in the price list carry a warranty, against manufacturing defects for a period of 24 months from the date of invoicing.
- The warranty is however subject to proper usage and maintenance and does not cover defects arising out of improper installation, inefficient maintenance, faulty operation and willful or accidental damage including nonperformance, which is caused by an event constituting Force Majeure, i.e. including (but not limited to) pandemic, fire, floods, administrative orders etc.
- Hager and / or manufacturer shall not be liable for any consequential loss, including personal injury or damages arising out of, or in connection with, defects in the Products including claim by third party.
- Proof of purchase to be retained to avail warranty.

Our network to serve you better

200+

Authorised Channel Partners

20+



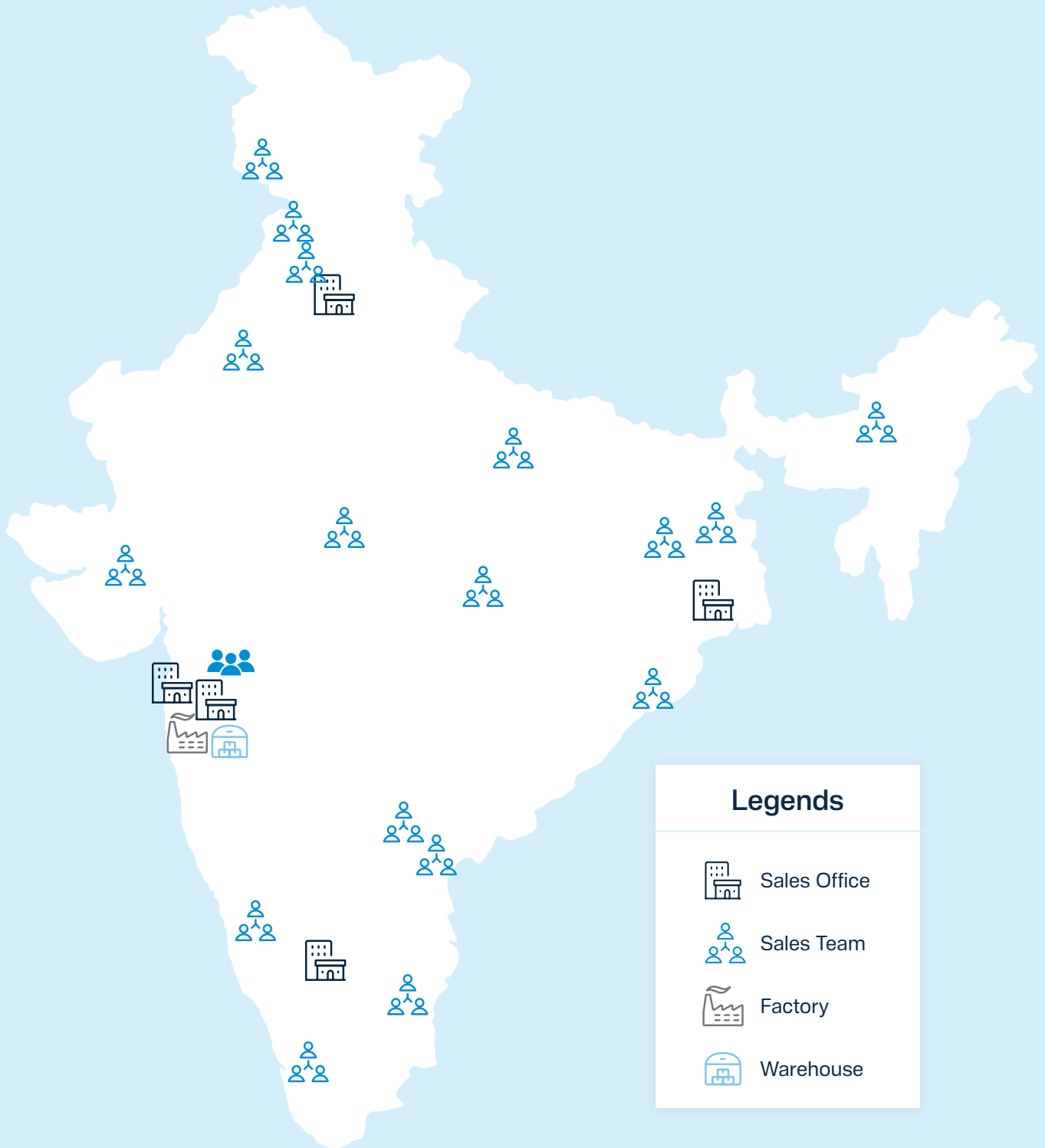

System Integrators

25+

Service Centers



Legends

-  Sales Office
-  Sales Team
-  Factory
-  Warehouse

Hager Electro Private Limited

Global Industrial Park, G. No. 185,
Alandi – Ahmednagar Road, Phulgaon, Pune 412216, India

Branch Office Hager Electro Pvt Ltd

Awfis Prestige DotCom 16,
2, Residency Rd, Srinivas Nagar,
Shanthala Nagar, Ashok Nagar,
Bengaluru, Karnataka 560025

Hager Electro Pvt Ltd

Wework Berger Delhi One
Sector 16 B, Noida,
Uttar Pradesh – 201301

Hager Electro Pvt Ltd

Wework Futura,
Magarpatta road,
Kirtane Baugh Pune – 411013

Hager Electro Pvt Ltd

Wework Hager, 12th Floor, 247 Park,
Hindustan C. Bus Stop,
Lal Bahadur Shastri Rd, Gandhi Nagar,
VikhroliWest, Mumbai, MH 400079



Tel: +91 20 66784500



Mail Us At- hagerwow.india@hager.com



Toll free no.: 1800 103 5440



Visit Us At- hager.co.in



German Quality

Better buildings
Better tomorrows **:hager**