

ELETTRO

Strong Connections, Stronger Performance...



Price List

9th MARCH 2026

Elettro: Your Reliable Source for Electrical Panel Accessories

Introduction:- Elettro is a reputable brand in the electrical industry, specializing in the production of a diverse range of high-quality electrical panel accessories. With a commitment to innovation, reliability, and customer satisfaction, Elettro has established itself as a leading provider of essential components for electrical panels. The company's website, <https://www.elettro.in> serves as a comprehensive platform where customers can explore their extensive product catalog and access valuable information and resources.

Product Range:- Elettro offers an impressive array of electrical panel accessories that cater to the needs of various industries and applications. Their product range includes air vents, junction boxes, flexible conduit pipes, cable ties and much more. From miniature components for compact panels to heavy-duty accessories for industrial setups, Elettro ensures that their offerings meet the highest standards of quality, performance, and safety.

Quality and Reliability:- Elettro quality and reliability are at the core of their operations. The company employs rigorous quality control measures throughout the manufacturing process to ensure that every product that leaves their facility meets stringent industry standards. By utilizing cutting-edge technology, superior materials, and advanced testing methods, Elettro guarantees the durability and performance of their electrical panel accessories, ensuring they can withstand demanding environments and provide reliable electrical connections.

Innovation and Customization:- Elettro understands the importance of staying ahead in a rapidly evolving industry. With a team of skilled engineers and designers, the company continuously innovates to develop new and improved products that meet the evolving needs of their customers. Furthermore, Elettro offers customization options, allowing clients to tailor their electrical panel accessories to specific requirements. This commitment to innovation and customization sets Elettro apart as a trusted partner for clients seeking specialized solutions.

Conclusion:- Elettro is a leading brand in the electrical industry, renowned for its extensive range of high-quality electrical panel accessories. With a commitment to quality, reliability, and innovation, the company has become a trusted partner for clients across diverse sectors. Whether you need components for residential, commercial, or industrial applications, Elettro's comprehensive product catalog and dedication to customer satisfaction make them the go-to choice for all your electrical panel accessory needs.

We have Certifications

Elettro is proud to present its latest range of Electrical Panel Board Accessories, designed to meet the highest standards of safety, reliability, and efficiency. Our commitment to quality and innovation ensures that every product in our catalog exceeds customer expectations and complies with industry benchmarks.

Certified Quality and Approvals :

All our electrical panel board accessories are crafted with precision, adhering to stringent manufacturing processes. They carry the necessary certifications and approvals from recognized authorities, ensuring compliance with global standards. The certifications our products hold are a testament to their durability, high performance, and safety under varied operating conditions.



OUR
COMMITMENT



Our Team



At Elettro, our motivated team thrives in a dynamic, collaborative environment, fostering innovation and excellence. United by passion and diverse perspectives, we craft cutting-edge electronic accessories, driven by a shared commitment to excellence.

PRODUCTION HOUSE



Elettro's advanced production house ensures high-quality electrical panel accessories with precision and durability. We focus on innovation, reliability and strict quality control.

SELF LOCKING PA 66 CABLE TIES

CE ROHS⁺ HSN CODE: 39235090



Technical Details	
• Material	PA 66 UL Certified 94V-2
• Operating Temp	-10°C to 130°C
• Oxygen Index	25% - 28%
• Smoke Density	Flaming 35 No Flaming 13

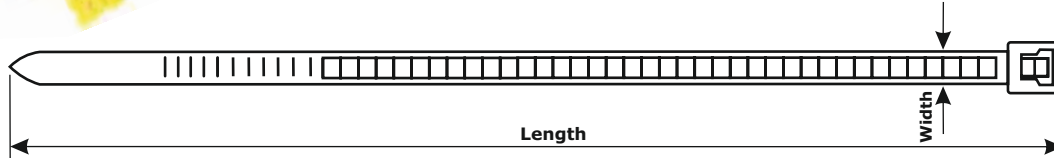

Cat. No.	Nominal Overall Length	Strap Width	Natural	Black	Coloured	UV Grade	Pieces/packet	CTN / Packet
			M.R.P. ₹	M.R.P. ₹	M.R.P. ₹	M.R.P. ₹		
MINIATURE SERIES								
ET 100 x 1.8	Length 100mm	X Width 1.8mm	38.00	41.00	43.00	45.00	100	600
ET 100 x 2.5	Length 100mm	X Width 2.5mm	46.00	48.00	50.00	52.00	100	600
ET 100 1k x 2.5	Length 100mm	X Width 2.5mm	410.00	430.00	450.00	470.00	1000	60
ET 150 x 2.5	Length 150mm	X Width 2.5mm	69.00	71.00	75.00	78.00	100	400
ET 200 x 2.5	Length 200mm	X Width 2.5mm	93.00	93.00	97.00	102.00	100	200
INTERMEDIATE SERIES								
ET 150 x 3.6	Length 150mm	X Width 3.6mm	105.00	106.00	111.00	115.00	100	300
ET 200 x 3.6	Length 200mm	X Width 3.6mm	135.00	135.00	141.00	147.00	100	200
ET 250 x 3.6	Length 250mm	X Width 3.6mm	184.00	189.00	198.00	207.00	100	150
ET 300 x 3.6	Length 300mm	X Width 3.6mm	205.00	210.00	220.00	230.00	100	150
STANDARD SERIES								
ET 200 x 4.8	Length 200mm	X Width 4.8mm	182.00	188.00	197.00	206.00	100	150
ET 250 x 4.8	Length 250mm	X Width 4.8mm	235.00	242.00	254.00	265.00	100	150
ET 300 x 4.8	Length 300mm	X Width 4.8mm	291.00	296.00	310.00	325.00	100	150
ET 350 x 4.8	Length 350mm	X Width 4.8mm	360.00	371.00	390.00	406.00	100	120
ET 400 x 4.8	Length 400mm	X Width 4.8mm	415.00	420.00	440.00	460.00	100	90
ET 450 x 4.8	Length 450mm	X Width 4.8mm	481.00	485.00	507.00	530.00	100	60
ET 500 x 4.8	Length 500mm	X Width 4.8mm	550.00	565.00	592.00	620.00	100	30
HEAVY DUTY SERIES								
ET 200 x 7.6	Length 200mm	X Width 7.6mm	385.00	375.00	392.00	410.00	100	60
ET 300 x 7.6	Length 300mm	X Width 7.6mm	522.00	555.00	580.00	606.00	100	60
ET 400 x 7.6	Length 400mm	X Width 7.6mm	700.00	700.00	732.00	770.00	100	50
ET 450 x 7.6	Length 450mm	X Width 7.6mm	850.00	895.00	935.00	980.00	100	50
ET 550 x 7.6	Length 550mm	X Width 7.6mm	1140.00	1230.00	1285.00	1340.00	100	40
ET 650 x 7.6	Length 650mm	X Width 7.6mm	1390.00	1485.00	1550.00	1625.00	100	30
ET 760 x 7.6	Length 760mm	X Width 7.6mm	1600.00	1620.00	1690.00	1775.00	100	30
ET 920 x 9.0	Length 920mm	X Width 9.0mm	2700.00	2910.00	3040.00	3200.00	100	10
ET 1020 x 9.0	Length 1020mm	X Width 9.0mm	3785.00	4080.00	4260.00	4550.00	100	10

TAG TYPE SERIES

Cat. No.	d1mm	inch	d2mm	inch	mm	inch	mm	kgf	lbs	M.R.P. ₹	Pieces	CTN
										PerPacked	Packed	Packed
ET-T 100 X 2.5	100	4	2.5	0.10	20	0.79	0.9	8	18	150.00	100	400

HSN CODE: 39235090



S.S. 304/316 ROLLER BALL 4.6mm CABLE TIES

 HSN CODE 73269060

GENERAL INFORMATION:

Yield Strength	190-280 MPa
Elongation	40-60%
Hardness	85 HRB (Rockwell B scale)
Temperature Range	-50°C to 500°C (-58°F to 932°F)

Cat. No.	Nominal Overall Length	Strap Width	M.R.P. ₹	Pieces/packet Std.Pkg.	CTN / Packet Std.Pkg.
ET-ST 100 X 4.6	Length 100mm	X Width 4.6mm	● Ask for Price.	100	10000
ET-ST 150 X 4.6	Length 150mm	X Width 4.6mm		100	10000
ET-ST 200 X 4.6	Length 200mm	X Width 4.6mm		100	10000
ET-ST 260 X 4.6	Length 260mm	X Width 4.6mm		100	10000
ET-ST 300 X 4.6	Length 300mm	X Width 4.6mm		100	10000
ET-ST 360 X 4.6	Length 360mm	X Width 4.6mm		100	5000
ET-ST 400 X 4.6	Length 400mm	X Width 4.6mm		100	5000
ET-ST 520 X 4.6	Length 520mm	X Width 4.6mm		100	5000
ET-ST 620 X 4.6	Length 620mm	X Width 4.6mm		100	5000
ET-ST 680 X 4.6	Length 680mm	X Width 4.6mm		100	5000
ET-ST 840 X 4.6	Length 840mm	X Width 4.6mm		100	2000
ET-ST 1000 X 4.6	Length 1000mm	X Width 4.6mm		100	2000

S.S. 304/316 ROLLER BALL 7.9mm CABLE TIES

 HSN CODE 73269060



GENERAL INFORMATION:

Tensile Strength	Typically around 550-700 MPa
Yield Strength	240-310 MPa
Elongation	40-60%
Hardness	95 HRB (Rockwell B scale)
Temperature Range	-50°C to 500°C (-58°F to 932°F)

Cat. No.	Nominal Overall Length	Strap Width	M.R.P. ₹	Pieces/packet Std.Pkg.	CTN / Packet Std.Pkg.
ET-ST 100 X 7.9	Length 100mm	X Width 7.9mm	● Ask for Price.	100	10000
ET-ST 150 X 7.9	Length 150mm	X Width 7.9mm		100	10000
ET-ST 200 X 7.9	Length 200mm	X Width 7.9mm		100	10000
ET-ST 260 X 7.9	Length 260mm	X Width 7.9mm		100	10000
ET-ST 300 X 7.9	Length 300mm	X Width 7.9mm		100	10000
ET-ST 360 X 7.9	Length 360mm	X Width 7.9mm		100	5000
ET-ST 400 X 7.9	Length 400mm	X Width 7.9mm		100	5000
ET-ST 520 X 7.9	Length 520mm	X Width 7.9mm		100	5000
ET-ST 620 X 7.9	Length 620mm	X Width 7.9mm		100	5000
ET-ST 680 X 7.9	Length 680mm	X Width 7.9mm		100	5000
ET-ST 840 X 7.9	Length 840mm	X Width 7.9mm		100	2000
ET-ST 1000 X 7.9	Length 1000mm	X Width 7.9mm		100	2000

POLYAMIDE FLEXIBLE CONDUIT & SLITTED CONDUIT

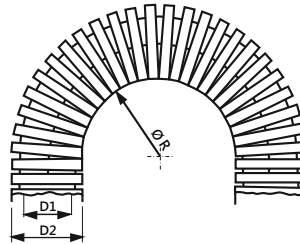
HSN CODE 39172190



POLYAMIDE FLEXIBLE PIPE POLYAMIDE FLEXIBLE SLITTED PIPE

DIMENSION DRAWING & TECHNICAL DETAILS

Technical Details :

Material	Polyamide 6
Flexural Strength	950 Kg / cm ²
Flexural Modulus	26,000 Kg / cm ²
Tensile Strength	700 Kg / cm ²
Impact Strength	25 Kg / cm ²
Temperature Range	-40°C to +120°C Continuous, +150°C Short Term
Resistant	Alcohol, Benzol, Greases, Mineral Oil, Diesel Fuel, Sea Water, Petrol etc.
Protection	IP 67
Approvals	CE ROHS

Cat. No.	Conduit Gland Size	Price /per Mtr. M.R.P. Rs.	Cat. No.	Price /per Mtr. (Slitted) M.R.P. ₹	Std. Roll Pkg. mtr.	Std.Pkg. mtr.
ETP-10	PG-7	38.00	ETP-10 ST	42.00	100	1000
ETP-13.5	PG-9	48.00	ETP-13.5 ST	52.00	100	1000
ETP-16	PG-11	62.00	ETP-16 ST	68.00	50	500
ETP-18.5	PG-13.5	77.00	ETP-18.5 ST	84.00	50	500
ETP-22	PG-16	93.00	ETP-22 ST	101.00	50	500
ETP-28	PG-21	145.00	ETP-28 ST	157.00	50	300
ETP-34	PG-29	188.00	ETP-34 ST	204.00	50	250
ETP-42	PG-36	275.00	ETP-42 ST	304.00	25	125
ETP-54	PG-48	405.00	ETP-54 ST	443.00	25	100
ETP-67	-----	1700.00	ETP-67 ST	1875.00	15	60
ETP-80	-----	2050.00	ETP-80 ST	2260.00	10	50
ETP-106	-----	3600.00	ETP-106 ST	4000.00	05	25

POLYAMIDE FLEXIBLE CONDUIT CLAMP

HSN CODE 39172190

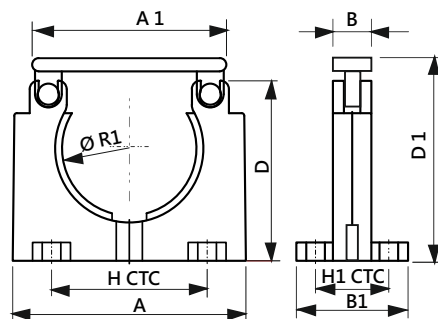

Technical Details :

Material	Polyamide 6
Temperature Range	-40°C to +120°C Continuous, +150°C Short Term
Resistant	Alcohol, Benzol, Greases, Mineral Oil, Diesel Fuel, Sea Water, Petrol etc.
Approvals	CE ROHS

Cat. No.	Clamp Size	M.R.P. ₹ Per Piece	Polybag Pkg Std.Pkg.	CTN Pkg Std.Pkg.
ETC-9	ETP-13.5	31.00	100 Nos	4000 Nos
ETC-11	ETP-16	33.00	100 Nos	4000 Nos
ETC-13.5	ETP-18.5	38.00	100 Nos	4000 Nos
ETC-16	ETP-22	40.00	100 Nos	4000 Nos
ETC-21	ETP-28	47.00	50 Nos	2000 Nos
ETC-29	ETP-34	75.00	50 Nos	2000 Nos
ETC-36	ETP-42	85.00	25 Nos	500 Nos
ETC-48	ETP-54	123.00	25 Nos	500 Nos

POLYAMIDE CONDUIT GLAND

HSN CODE 39172190

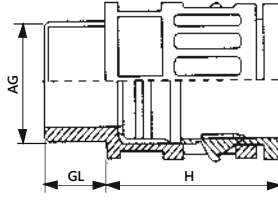

Technical Details :

Material	Polyamide 6
Temperature Range	-40°C to +120°C Continuous, +150°C Short Term
Resistant	Alcohol, Benzol, Greases, Mineral Oil, Diesel Fuel, Sea Water, Petrol etc.
Approvals	CE ROHS

Cat. No.	Conduit Pipe Size	M.R.P. ₹	Std.Pkg.
ETG-7	ETP-10 Conduit Size	● Ask for Price.	100 Nos
ETG-9	ETP-13.5 Conduit Size		100 Nos
ETG-11	ETP-16 Conduit Size		100 Nos
ETG-13.5	ETP-18.5 Conduit Size		100 Nos
ETG-16	ETP-22 Conduit Size		100 Nos
ETG-21	ETP-28 Conduit Size		50 Nos
ETG-29	ETP-34 Conduit Size		25 Nos
ETG-36	ETP-42 Conduit Size		20 Nos
ETG-48	ETP-54 Conduit Size		10 Nos

POLYAMIDE FLEXIBLE CONDUIT METRIC GLANDS

HSN CODE 39172190

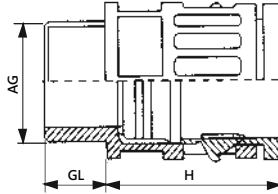

General Information

Material	Polyamide (Nylon 6)
Type	Metric Threads Gland for Flexible Conduit
Colour	Black (Standard), other colors available on request
Temperature Rang	-40°C to 120°C (Intermittent +150°C)
Approvals	CE ROHS

Cat. No.	Conduit Pipe Size	M.R.P. ₹	Std.Pkg.
ETMG-16	ETP-16 Conduit Size	● Ask for Price.	100 Nos
ETMG-20 M-20 (M-15.8)	ETP-16 Conduit Size		100 Nos
ETMG-25 M-20 (M-21.2)	ETP-22 Conduit Size		100 Nos
ETMG-25 M-25 (M-21.2)	ETP-22 Conduit Size		100 Nos
ETMG-32 M-32	ETP-34 Conduit Size		50 Nos
ETMG-40 M-40	ETP-42 Conduit Size		50 Nos
ETMG-50 M-50	ETP-54 Conduit Size		50 Nos
ETMG-63 M-63	ETP-54 Conduit Size		50 Nos

POLYAMIDE FLEXIBLE CONDUIT 90° ELBOW GLANDS

HSN CODE 39172190

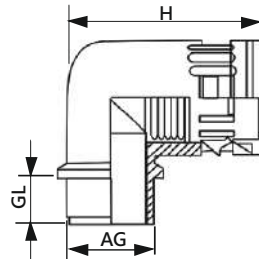

General Information

Material	(Polyamide 6)
Design & Construction	Angle: 90° Elbow
Colour	Black (Standard), other colors available on request
Temperature Rang	Static: -40°C to +120°C Dynamic: -20°C to +90°C
Approvals	CE ROHS IP65 TO IP68 (depending on the model and assembly)

Cat. No.	Conduit Pipe Size	M.R.P. ₹	Std.Pkg.
ETEG-7	ETP-10 Conduit Size	● Ask for Price.	100 Nos
ETEG-9	ETP-13.5 Conduit Size		100 Nos
ETEG-11	ETP-16 Conduit Size		100 Nos
ETEG-13.5	ETP-18.5 Conduit Size		100 Nos
ETEG-16	ETP-22 Conduit Size		50 Nos
ETEG-21	ETP-28 Conduit Size		50 Nos
ETEG-29	ETP-34 Conduit Size		50 Nos
ETEG-36	ETP-42 Conduit Size		50 Nos
ETEG-48	ETP-54 Conduit Size		50 Nos

AIR- VENT

CE ROHS[✓] HSN CODE: 84213100

(VALUE & ECONOMIC SERIES)

Cat. No.	Size	M.R.P. ₹	Std.Pkg.
ETAV-01	130mmX130mm (SCREW FIT)	120.00	300 Nos
ETAV-01 VP	130mmX130mm(SCREW FIT) (VP-10 Nos.)	1080.00	30 Packs
ETAV-02	147mmX147mm (SNAP FIT)	169.00	200 Nos
ETAV-02 VP	147mmX147mm (SNAP FIT) (VP-10 Nos.)	1550.00	24 Packs
ETAV-03	184mmX184mm (SCREW FIT)	310.00	150 Nos
ETAV-03 VP	184mmX184mm (SCREW FIT) (VP-10 Nos)	2750.00	16 Packs
ETAV-04	203mmX203mm (SNAP FIT)	370.00	100 Nos
ETAV-04 VP	203mmX203mm (SNAP FIT) (VP-10 Nos.)	3500.00	12 Packs
ETAV-05	238mmX238mm (SCREW FIT)	555.00	60 Nos
ETAV-05 VP	238mmX238mm (SCREW FIT) (VP-5 Nos.)	2580.00	12 Packs
ETAV-06	255mmX255mm (SNAP FIT)	680.00	60 Nos
ETAV-06 VP	255mmX255mm (SNAP FIT) (VP-5 Nos.)	3200.00	12 Packs
ETAV-09	325mmX325mm (SNAP FIT)	1250.00	25 Nos
ETAV-10	117mmx117mm (SNAP FIT)	150.00	150 Nos
ETAV-11	90mmX90mm (SCREW FIT)	110.00	200 Nos
ETAV-204/DT	204mmX204mm (DOOM TYPE)	500.00	30 Nos
ETAV-255/DT	255mmX255mm (DOOM TYPE)	790.00	25 Nos
ETAD-285	285mmX285mm (SCREW FIT) (ADAPTOR)	260.00	50 Nos



Colour Shade- RAL7035 /RAL7032
COLOUR ON REQUEST RAL 9005(BLACK)

AIR- VENT (OVAL DESIGN) (PREMIUM SERIES)

CE ROHS[✓] HSN CODE: 84213100



Colour Shade- RAL7035
COLOUR ON REQUEST RAL 9005(BLACK)

Cat. No.	Size	M.R.P. ₹	Std.Pkg.
ETAV-130/4	130mm x 130mm (SCREW FIT)	130.00	300 Nos
ETAV-150/SF-4	150mm x 150mm (SNAP FIT)	200.00	200 Nos
ETAV-184/6	184mm x 184mm (SCREW FIIT)	350.00	150 Nos
ETAV-204/SF-4/6	204mm x 204mm (SNAP FIT)	410.00	100 Nos
ETAV-238/8	238mm x 238mm (SCREW FIT)	590.00	60 Nos
ETAV-255/SF-6/8	255mm x 255mm (SNAP FIT)	725.00	60 Nos

AIR- VENT (WITH E.P.D.M GASKETING)

CE ROHS[✓] IP54 IP55 HSN CODE: 84213100

Cat. No.	Size	M.R.P. ₹	Std.Pkg.
ETAV-150/SF-4 EG	150mm x 150mm	300.00	150 Nos
ETAV-204/SF-4/6 EG	204mm x 204mm	515.00	100 Nos
ETAV-255/SF-6/8EG	255mm x 255mm	783.00	50 Nos
ETAV-09/EG	325mm x 325mm	1480.00	25 Nos
ETAV-117/SF-3/3.5EG	117mm x 117mm	190.00	150 Nos
ETAV-204/DT-1EG	204mm x 204mm (Doom Type)	560.00	30 Nos
ETAV-255/DT-1EG	255mm x 255mm (Doom Type)	850.00	25 Nos



Colour Shade- RAL7035 /RAL7032
COLOUR ON REQUEST RAL 9005(BLACK)

JUNCTION BOX

JUNCTION BOX W/O Connector IP-65

CE ROHS⁺ IP65 HSN CODE: 85359040

Cat. No.	Size	M.R.P. ₹	Std.Pkg.
ET - 9020	88mm x 88mm x 53mm	290.00	150 Nos
ET - 9040	98mm x 98mm x 61mm	320.00	150 Nos
ET - 9060	139mm x 119mm x 70mm	500.00	50 Nos
ET - 9100	167mm x 125mm x 82mm	725.00	30 Nos
ET - 9250	200mm x 160mm x 98mm	1350.00	30 Nos
ET - 9350	260mm x 210mm x 117mm	2750.00	10 Nos



Colour Shade - RAL-7035 Material: pc

JUNCTION BOX With Brass Connector IP-65

Cat. No.	Size	M.R.P. ₹	Std.Pkg.
ET - 9020E	88mm x 88mm x 53mm (2.5 Sq.mm)	370.00	150 Nos
ET - 9040E	98mm x 98mm x 61mm (4/6 Sq.mm)	400.00	150 Nos
ET - 9060E	139mm x 119mm x 70mm (10 Sq.mm)	780.00	50 Nos
ET - 9100E	167mm x 125mm x 82mm (16 Sq.mm)	1590.00	30 Nos
ET - 9250E	200mm x 160mm x 98mm (16 Sq.mm)	2500.00	30 Nos
ET - 9350E	260mm x 210mm x 117mm (25 Sq.mm)	3910.00	10 Nos

JUNCTION BOX

CE ROHS⁺ IP55 IP65 HSN CODE: 85359040



Colour Shade - RAL-7035 Material: A.B.S.

Cat. No.	Size	Grey colour M.R.P. ₹	Transparent M.R.P. ₹	
ET - 10107	100mm x 100mm x 70mm	180.00	216.00	200 Nos
ET - 15117	150mm x 110mm x 70mm	300.00	360.00	75 Nos
ET - 15157	150mm x 150mm x 70mm	350.00	420.00	75 Nos
ET - 20107	200mm x 100mm x 70mm	360.00	432.00	50 Nos
ET - 20168	200mm x 155mm x 80mm	480.00	576.00	50 Nos
ET - 201612	200mm x 155mm x 120mm	790.00	948.00	40 Nos
ET - 26208	255mm x 200mm x 80mm	705.00	846.00	30 Nos
ET - 262012	255mm x 200mm x 120mm	920.00	1104.00	30 Nos
ET - 302512	300mm x 250mm x 120mm	1325.00	1590.00	20 Nos
ET - 302515	300mm x 250mm x 150mm	1650.00	1980.00	10 Nos
ET - 403512	400mm x 350mm x 120mm	3050.00	3660.00	7 Nos

CE ROHS⁺ IP67 HSN CODE: 85359040



Colour Shade - RAL-7035 Material: A.B.S.

Cat No.	Size	M.R.P. ₹	Std. Pkg.
ET-6001	110mmX110mmX110mm	600.00	50 Nos
ET-6002	155mmX115mmX110mm	700.00	50 Nos

DISTRIBUTION BOX



 HSN CODE: 85359040



Cat. No.	Size	M.R.P. ₹	Std.Pkg.
ETDB -02 (2Way)	120mm x 53mm	335.00	150 Nos
ETDB -05 (5Way)	159mm x 119mm	500.00	85 Nos
ETDB -08 (8Way)	201mm x 153mm	1000.00	50 Nos
ETDB -12 (12Way)	256mm x 196mm	1600.00	30 Nos
ETDB -18 (18Way)	360mm x 194mm	3500.00	15 Nos
ETDB -24 (24Way)	357mm x 271mm	4400.00	15 Nos

PC SOLAR JUNCTION BOX







Cat. No.	Size	M.R.P. ₹	Std.Pkg.
ET - SJB / 01 / AA-H	180mm x 130mm x 100mm (Transparent With Hinges)	525.00	45 Nos
ET - SJB / 01 / AA	180mm x 130mm x 100mm (Transparent)	525.00	45 Nos
ET - SJB / 01 / AC	180mm x 130mm x 100mm (Grey)	500.00	45 Nos
ET - SJB / 02 / AA	180mm x 180mm x 100mm (Transparent)	850.00	30 Nos
ET - SJB / 02 / AC	180mm x 180mm x 100mm (Grey)	810.00	30 Nos
ET - SJB / 03 / AA	220mm x 190mm x 100mm (Transparent)	1060.00	20 Nos
ET - SJB / 03 / AC	220mm x 190mm x 100mm (Grey)	1000.00	20 Nos
ET - SJB / 04 / AA	280mm x 190mm x 130mm (Transparent)	1630.00	16 Nos
ET - SJB / 04 / AC	280mm x 190mm x 130mm (Grey)	1550.00	16 Nos

JUNCTION BOX WINDOW



 HSN CODE: 85359040



Cat. No.	ITEM	M.R.P. ₹	Std.Pkg.
ETJBW - 3	JUNCTION BOX WINDOW - 3 WAY	645.00	120 Nos
ETJBW - 4	JUNCTION BOX WINDOW - 4 WAY	700.00	100 Nos
ETJBW - 6	JUNCTION BOX WINDOW - 6 WAY	1025.00	100 Nos
ETJBW - 8	JUNCTION BOX WINDOW - 8 WAY	1275.00	100 Nos
ETJBW - 12	JUNCTION BOX WINDOW - 12 WAY	1610.00	50 Nos

TOGGLE SWITCHES

6A/10A /15A 250AC SINGLE & DOUBLE POLE



SINGLE POLE UNSEALED

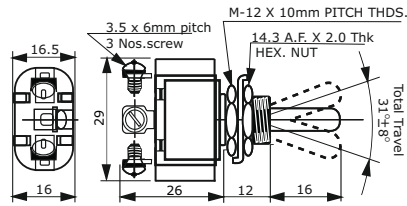

DOUBLE POLE UNSEALED

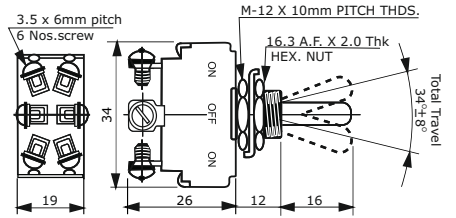

Cat. No.	Rating	Description	M.R.P. ₹	Std. Pkg
ETS-601	6A	SPST ON- OFF	160.00	30 NOS
ETS-602	6A	SPDT ON ON	175.00	30 NOS
ETS-603	6A CENTRE OFF	SPDT ON-OFF-ON	175.00	30 NOS
ETS-606	6A	DPST ON-OFF	195.00	30 NOS
ETS-607	6A	DPDT ON ON	217.00	30 NOS
ETS-608	6A CENTRE OFF	DPDT ON-OFF-ON	217.00	30 NOS
ETS-1001	10A	SPST ON- OFF	170.00	30 NOS
ETS-1002	10A	SPDT ON ON	185.00	30 NOS
ETS-1003	10A CENTRE OFF	SPDT ON-OFF-ON	185.00	30 NOS
ETS-1006	10A	DPST ON-OFF	230.00	30 NOS
ETS-1007	10A	DPDT ON ON	255.00	30 NOS
ETS-1008	10A CENTRE OFF	DPDT ON-OFF-ON	255.00	30 NOS
ETS-1501	15A	SPST ON- OFF	195.00	30 NOS
ETS-1502	15A	SPDT ON ON	215.00	30 NOS
ETS-1503	15A CENTRE OFF	SPDT ON-OFF-ON	215.00	30 NOS
ETS-1506	15A	DPST ON-OFF	255.00	30 NOS
ETS-1507	15A	DPDT ON ON	288.00	30 NOS
ETS-1508	15A CENTRE OFF	DPDT ON-OFF-ON	305.00	30 NOS

PANEL DOOR SWITCHES

Cat. No.	Colour	M.R.P. ₹	Std. Pkg.
ETDS-01	White & Black	● Ask for Price.	1000 Nos

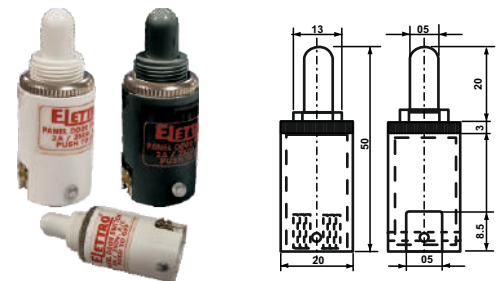

L.T. CONTROL SWITCHES



RANG & SEQUENCE

RATING	ON-OFF	REVERSING	CHANGEVER
16 Amps. 440 Volts AC 50 Hz.	SIT EO.16	SIT EO.16	SIT EO.16

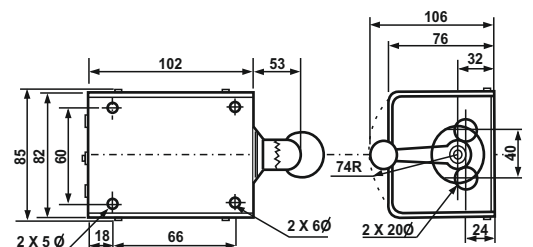

ET-16	BAKELITE HANDLE ROUND MODEL 16 AMP 440 V	● Ask for Price.	64 NOS
ET16SH	STEEL HANDLE ROUND MODEL 16 AMP 440 V		64 NOS
ET32SH	32 AMP. 440V REVERSE FORWARD SWITCH WITH STEEL HANDLE		64 NOS

SELF ADHESIVE GASKET TAPE

HSN CODE: 39199020

PRODUCT SPECIFICATIONS

- Self Life : 1 Years
- Adhesive Side : Single Side
- Peeling Strength : >550gms / 25mm
- Material : EVA FOAM
- Tape Type : Single Side Gasket Type
- Adhesive Type : Pressure Sensitive
- Colour : Black

PRODUCT SPECIFICATIONS

- Use commonly in sealing Industrial electrical panels, compartments with application even in Bus & Truck body, these Tape most commonly use EVA Foam as the substrate and are coated with an Acrylic Adhesive , Commonly Available in Black Colour .
- Thickness : 2mm, 3mm, 5mm, 6mm , 8mm & 10mm
- Widths : 12mm to 100mm.



	M.R.P. ₹	M.R.P. ₹	M.R.P. ₹	M.R.P. ₹	M.R.P. ₹	M.R.P. ₹	M.R.P. ₹
Thickness	2 mm	3 mm	4 mm	5 mm	6 mm	8 mm	10 mm
Width	10 Mtr	10 Mtr	10 Mtr	10 Mtr	10 Mtr	5 Mtr	5 Mtr
10mm	77.00	100.00	125.00	138.00	160.00	115.00	135.00
12mm	92.00	115.00	145.00	170.00	190.00	135.00	160.00
15mm	115.00	145.00	185.00	210.00	240.00	165.00	200.00
20mm	150.00	190.00	240.00	275.00	315.00	220.00	265.00
24mm	182.00	235.00	295.00	335.00	380.00	265.00	320.00
25mm	190.00	240.00	305.00	345.00	395.00	275.00	330.00
30mm	225.00	290.00	365.00	415.00	475.00	330.00	400.00
40mm	300.00	385.00	480.00	545.00	630.00	440.00	540.00
50mm	375.00	475.00	600.00	690.00	790.00	545.00	660.00
60mm	445.00	570.00	725.00	825.00	940.00	650.00	790.00
80mm	595.00	760.00	960.00	1100.00	1260.00	875.00	1065.00
100mm	740.00	945.00	1200.00	1370.00	1575.00	1100.00	1320.00

White Eva Foam Also Available

as per Request Kindly note Price will be High by 7.5% on the above Prices

STD PACKING	
Thickness	2mm & 3mm
Length	10 Mtr Per roll
Width	Qty Per Ctn
12mm	300 Rolls
15mm	240 Rolls
20mm	180 Rolls
25mm	144 Rolls
30mm	120 Rolls
40mm	90 Rolls
50mm	72 Rolls

STD PACKING	
Thickness	4mm , 5mm & 6mm
Length	10 Mtr Per roll
Width	Qty Per Ctn
12mm	180 Rolls
15mm	160 Rolls
20mm	120 Rolls
25mm	96 Rolls
30mm	80 Rolls
40mm	60 Rolls
50mm	48 Rolls

STD PACKING	
Thickness	8mm & 10mm
Length	5 Mtr Per roll
Width	Qty Per Ctn
12mm	180 Rolls
15mm	160 Rolls
20mm	120 Rolls
25mm	96 Rolls
30mm	80 Rolls
40mm	60 Rolls
50mm	48 Rolls

FAN FINGER GUARD

CE ROHS⁺ HSN CODE: 84149090

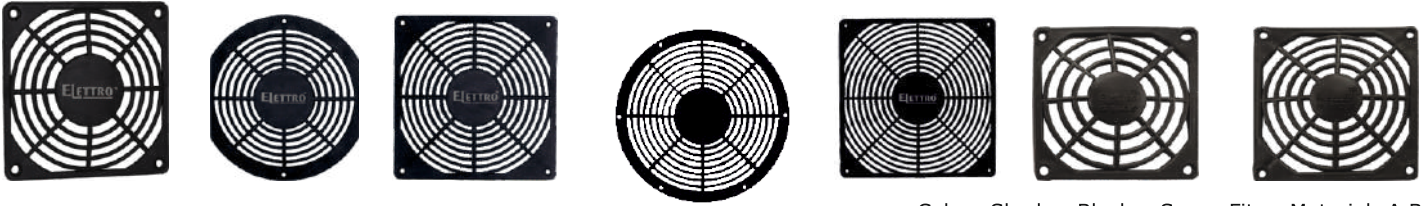

Colour Shade - Black Screw Fit Material: A.B.S.

Cat. No.	Description (Size)	M.R.P. ₹	Std.Pkg.
ETFG-01	4" Square (120mm x 120mm)	24.00	500 Nos
ETFG-02	6" Oval (172mm x 150mm)	45.00	300 Nos
ETFG-03	6" Square (172mm x 172mm)	45.00	300 Nos
ETFG-04	8" Round (200mm) Ø	70.00	300 Nos
ETFG-05	8" Square (220mm x 220mm)	70.00	300 Nos
ETFG-06	3" Square (80mm x 80mm)	22.00	500 Nos
ETFG-07	3.5" Square (92mm x 92mm)	22.00	500 Nos
ETAB-01	AIR BREATHER	58.00	1000 Nos

METAL FAN FINGER GUARD

HSN CODE 84149040

Cat. No.	Size	Std.Pkg.
ETMG-01	4" Square (1.6 Thk -8 Ring)	1000 Nos
ETMG-02	6" Oval (1.6 Thk -7 Ring)	400 Nos
ETMG-03	6" Square (1.6 Thk -8 Ring)	200 Nos
ETMG-04	8" Oval (1.6 Thk -11 Ring)	200 Nos
ETMG-05	8" Square (1.6 Thk -11 Ring)	200 Nos
ETMG-08	10" Square(1.6 Thk -14 Ring)	100 Nos
ETMG-06	3" Square(1.6 Thk -6 Ring)	1000 Nos
ETMG-07	3.5" Square(1.6 Thk -8 Ring)	1000 Nos

● Ask for Price.

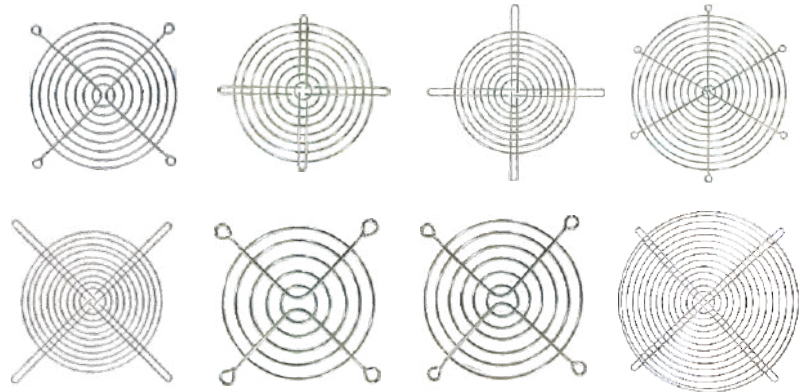

Colour Shade - Chrome plated Screw Fit Material: M.S.

DOCUMENT HOLDER

CE ROHS⁺ HSN CODE: 39261019



ETDH-01

ETDH-02

ETDH-03

Cat. No.	Size	M.R.P. ₹	Std.Pkg.
ETDH-01	188mm x 185mm x 20mm Deep	145.00	100 Nos
ETDH-02	258mm x 235mm x 35 Deep (A-4 Size)	270.00	50 Nos
ETDH-03	282mm x 236mm x 17 Deep (A-4 Size)	250.00	100 Nos

Colour Shade - RAL-7035 Screw Fit
Material: A.B.S.

◆ With adhesive Double sided tape

OTHER ACCESSORIES

HSN CODE: 39269099

ETPL-06

ETPL-07

ETPL-07-1

ETPL-09

ETSL-01
 GRAY / BLACK Colour

ETLP-01

ETLP-02

ETHL-01

ETBL-01

Colour shade : White

ETHD-19 ETHD-25 ETHD-40

ET 4 (PA)
 GRAY / BLACK Colour

ETEC-101

Cat. No.	Size	M.R.P. ₹ Per Piece	Polybag Pkg Std.Pkg.	CTN Pkg Std.Pkg.
ETPL-06	135mm x 25mm x 40mm (115mm CTC)	68.00	50 Nos	500 Nos
ETPL-07	94mm x 42mm x 17mm (94mm)	45.00	100 Nos	1000 Nos
ETPL-07-1	109mm x 51mm x 25mm (109mm)	75.00	50 Nos	500 Nos
ETPL-09	96mm x 90 mm x 15mm	23.00	100 Nos	500 Nos
ETSL-01	45mm x 28mm x 80mm	28.00	100 Nos	2000 Nos
ETBL-01	Ø22.5mm Thrd. x 18mm H Blanker	13.00	100 Nos	2000 Nos
ETLP-01	(25mm x 11mm) Ø 22.2 Legend Plate	12.00	100 Nos	2000 Nos
ETLP-06	(25mm x 18mm) Ø 22.2 Legend Plate	16.00	100 Nos	2000 Nos
ETHL-01	(50mm x 70mm) with SS pin	170.00	100 Nos	500 Nos
ETEC-101	END CLAMP / STOPPER	19.00	100 Nos	2500 Nos
ETHD-19	Self Adhesive Tie Mount (19mm x 19mm)	140.00	100 Nos	20000 Nos
ETHD-25	Self Adhesive Tie Mount (25mm x 25mm)	185.00	100 Nos	15000 Nos
ETHD-40	Self Adhesive Tie Mount (40mm x 40mm)	500.00	100 Nos	4000 Nos
ETPA-19 / 3M	Self Adhesive Tie Mount (19mm x 19mm)	-----	100 Nos	20000 Nos
ETPA-25 / 3M	Self Adhesive Tie Mount (25mm x 25mm)	-----	100 Nos	15000 Nos
ETPA-40 / 3M	Self Adhesive Tie Mount (40mm x 40mm)	-----	100 Nos	4000 Nos
ET4(PA)	Screw type Tie Mount	350.00	100 Nos	10000 Nos

CAMERA BOX

CE ROHS HSN CODE: 85359040



Colour Shade - White Material: P.P.

Cat. No.	Size	M.R.P. ₹	Std. Pack
ETCB-01	100mmx100mmx70mm	120.00	200 NOS
ETCB-02	100mmx100mmx50mm	68.00	360 NOS

PUSH BUTTON STATION

CE ROHS HSN CODE: 85359090



Cat. No.	Size	M.R.P. ₹	Std. Pack
ETPB-01 1Way	73mm x 73mm X 68mm	140.00	200 Nos
ETPB-02 2Way	113mm x 73mm X 68mm	170.00	150 Nos
ETPB-03 3Way	153mm x 73mm X 68mm	220.00	100 Nos
ETPB-04 4Way	192mm x 73mm X 68mm	250.00	80 Nos
ETPB-06 6Way	252mm x 73mm X 68mm	380.00	50 Nos





SCAN FOR CATALOGUE

Product Range

CE ROHS

IP42 IP54 IP55 IP65 IP67



TOGGLE SWITCHES METAL FAN FINGER GUARD AIR-VENT JUNCTION AIR-VENT
POLYAMIDE FLEXIBLE CONDUIT PIPE LEGEND PLATE
BLANKER PANEL DOOR SWITCHES FAN FINGER
SELF ADHESIVE GASKET TAPE DOCUMENT HOLDER
POLYAMIDE CONDUIT GLAND PUSH BUTTON STATION TOGGLE SWITCHES
POLYAMIDE FLEXIBLE CONDUIT CLAMP AIR-VENT AIR VENT

Manufacture by :

K. N. Elettro Industries Pvt. Ltd.

Web.: www.elettro.in