

RANGE IN INDUSTRIAL SWITCHES AND COMPONENTS

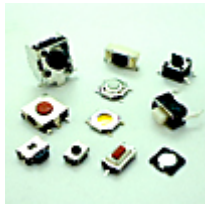

SMD TACT SWITCHES



SMD SLIDE SWITCH



TACT SWITCHES



ROCKER SWITCH



TOGGLE SWITCH



ROCKER PADDEL



SEALED TOGGLE



POWER TOGGLE



POWER SLIDE



LIGHT SWITCH



MINI PUSH SWITCHES



POWER PUSH



MICRO SWITCHES

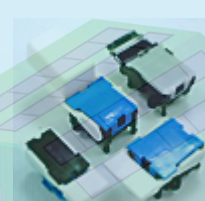

HOOK SWITCHES



SLIDE SWITCHES

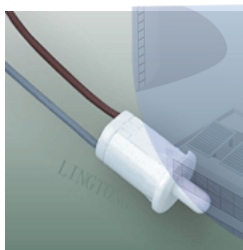

DOOR SWITCHES

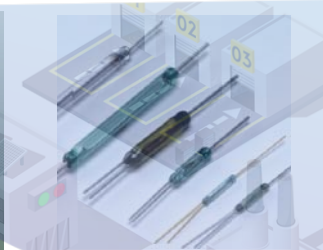

REED SWITCH

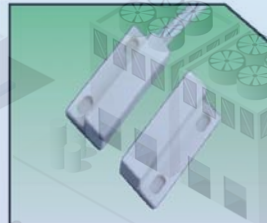

MAGNETIC SWITCHES

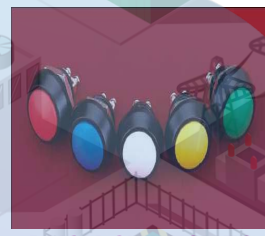

PUSH SWITCHES



KEY SWITCH + LED

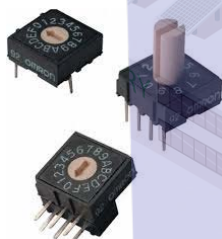

DIP ROTARY SWITCH

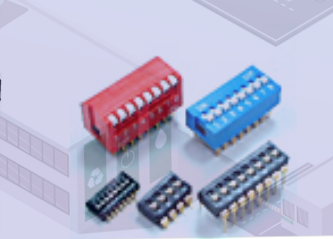

DIP SWITCHES



FLOAT SWITCH



DOMES SWITCHES



GANG SWITCH



PANAL LAMP



16MM PUSH SWITCH



25MM ILLUMINATED PUSH BUTTON





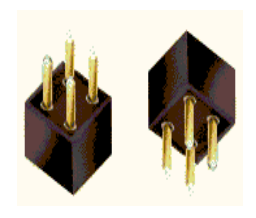



















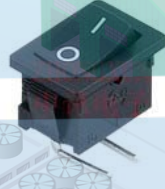





16MM ILLUMINATED SWITCHES

























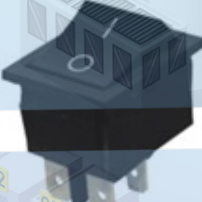

360* VIBRATION SENSOR VS-001

ROCKER SWITCHES

 SMRS-101 ON-OFF 3AMP/250V	 SMRS-102 ON-ON 3AMP/250V	 R-SMRS-101-8C 3AMP/250V	 R-SMRS-102-8C 3AMP/250V
 RS-12 ON-OFF 6AMP/250V	 MRS-111 OFF-(ON) 6AMP/250V	 MRS-102 ON-ON 6AMP/250V	 MRS-103 ON-OFF-ON MRS-113 (ON)-OFF-ON MRS-123 (ON)-OFF-(ON)
 RS-12 WITH LED 1.2V	 IRS-14 3PIN 6AMP/250V	 IRS-14 6AMP/250V	 RS-14 6AMP/250V
 RS-15 DPDT ON-ON	 RS-16 DPDT ON-OFF-ON	 RS-12-C3	 RS-14-C3
 MRS-103-C3	 RS-101-6C	 IRS-101-6C	 RS-101-8C
 RS-102-8C SPDT ON-ON	 IRS-101-8C WITH LIGHT	 SS-RS-14 8C DPST	 SS-IRS-14-8C DPST
 SS-RS-16-8C DPDT	 RS-17 6AMP/250V ON-OFF	 RS-18 DPDT ON-ON	 RS-19 DPDT ON-OFF-ON

IRS-WITH LIGHT
RS-NO LIGHT

ROCKER SWITCHES











 IRS-17 ON-OFF WITH LIGHT	 IRS-18 DPDT WITH LIGHT	 MRS-211 OFF-(ON)	 SS-RS-17 ON-OFF 10AMP/250V
 RS-101 ON-OFF	 RS-102 ON-ON	 RS-103 ON-OFF-ON	 IRS-101 15AMP/250V
 SS-RS-101-BIG	 SS-RS-102-BIG	 SS-IRS-101-BIG	 SS-RS-104-4PIN
 SS-IRS-104-4PIN	 RS-201-1C ON-OFF SIZE-22MM X 28MM	 IRS-201-1C ON-OFF SIZE-22MM X 28MM	 RS-202 ON-ON SIZE-22MM X 28MM/30MM 25AMP/250V
 RS-212 ON-(ON) SIZE-22MM X 28MM	 IRS-202 + LIGHT SIZE-22MM X 28MM	 RS-201-2C SIZE-22MM X 30MM	 LC-IRS-201-2C SIZE-22MM X 30MM
 CWS-123 (ON)-OFF-(ON)	 RS-203 ON-OFF-ON	 RS-223 (ON)-OFF-(ON)	 IRS-205
			 IRS-204

DUST PROOF SWITCHES

 RS-12	 RS-14	 RS-101	 ZX-IRS-201-1C WITH CAP	 SS-IRS-201-2C
--	--	---	--	--

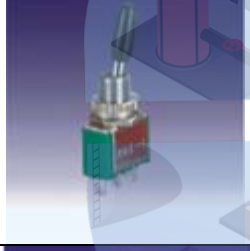
(ON)-OFF-(ON) spring return both sides

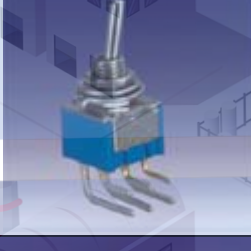
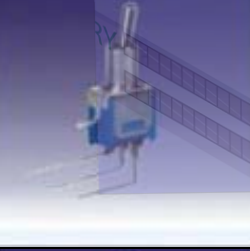
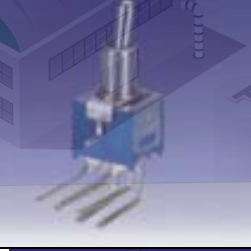





















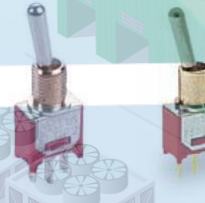
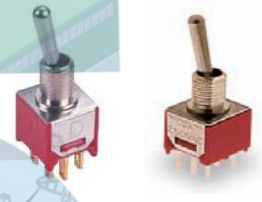

TOGGLE SWITCHES

	<p>SMTS-102 ON-ON 1AMP/250VAC</p> <p>SMTS-102-A2 ON-ON 1AMP/250VAC</p> <p>P.C.B MOUNTING</p>		<p>SMTS-202 ON-ON 1AMP/250VAC</p> <p>SMTS-202-A2 ON-ON 1AMP/250VAC</p> <p>P.C.B MOUNTING</p>
	<p>MTS-102 ON-ON</p> <p>MTS-103 ON-OFF-ON</p> <p>MTS-112 ON-(ON)</p> <p>MTS-113 ON-OFF-(ON)</p> <p>MTS-123 (ON)-OFF-(ON)</p>		<p>MTS-202 ON - ON</p> <p>MTS-203 ON-OFF-ON</p> <p>MTS-212 ON - (ON)</p> <p>MTS-213 ON-OFF-(ON)</p> <p>MTS-223 (ON)-OFF-(ON)</p>
	<p>MTS-102-A2 ON-ON</p> <p>3AMP/250VAC PCB MOUNTING</p> <p>MTS-103-A2 ON-OFF-ON</p>		<p>MTS-202-A2 ON-ON</p> <p>3AMP/250VAC PCB MOUNTING</p> <p>MTS-203-A2 ON-OFF-ON</p>
	<p>KNX-1 ON-ON</p> <p>3AMP/250VAC</p> <p>KNX-103 ON-OFF-ON</p>		<p>KNX-2 ON-ON</p> <p>3AMP/250VAC</p> <p>KNX-203 ON-OFF-ON</p>
	<p>MTS-102-C3 ON-ON</p> <p>3AMP/250VAC</p> <p>MTS-103-C3 ON-OFF-ON</p>		<p>MTS-202-C3 ON-ON</p> <p>3AMP/250VAC</p>
	<p>SMTS-102-C4 ON-ON</p> <p>1AMP/250V</p>		<p>SMTS-202-C4 ON-ON</p> <p>1AMP/250V</p>
	<p>MTS-102-C4 ON-ON</p> <p>3AMP/250V</p>		<p>MTS-202-C4 ON-ON</p> <p>3AMP/250V</p>

TOGGLE SWITCHES

 <p>R-11 CAP MTS-102-C3 ON-ON MTS-103-C3 ON-OFF-ON</p>	 <p>P-14 CAP MTS-102 ON-ON MTS-103 ON-OFF-ON</p>	 <p>R-12 CAP MTS-202 ON-ON MTS-203 ON-OFF-ON</p>	 <p>MTS-223 (ON)OFF(OFF) F11 CAP DPDT</p>
 <p>KN3A-123 (ON)OFF(OFF) SPRING RETURN SPDT</p>	 <p>KN3A-223 (ON)OFF(OFF) SPRING RETURN DPDT</p>	 <p>KN3A-101AA ON-OFF 15AMP/250V SPST</p>	 <p>KN3A-102 ON-ON 15AMP/250V SPDT</p>
 <p>KN3A-103 ON-OFF-ON SPDT</p>	 <p>KN3C-201 ON-OFF DPST</p>	 <p>KN3C-202 ON-ON DPDT</p>	 <p>KN3C-203 ON-OFF-ON DPDT</p>
 <p>KN3C-302 ON-ON</p>	 <p>KN3C-303 ON-OFF-ON</p>	 <p>KN3C-402 ON-ON</p>	 <p>KN3C-403 ON-OFF-ON</p>
 <p>P-KN3A-101A ON-OFF</p>	 <p>P-KN3A-101B PUSH ON</p>	 <p>IP68 protection level WATERPROOF</p>	 <p>IP68 protection level WATERPROOF</p>
 <p>12V DC ASW-07</p>	 <p>ASW-14 12V DC</p>	 <p>ASW-15 12V DC</p>	 <p>ASW-07 12V DC</p>

MADE BY TAIWAN

 <p>SH-P-SMTS-101 PUSH ON SPST</p>	 <p>SH-P-SMTS-102 PUSH ON SPDT</p>	 <p>SH-P-SMTS-101-C3 PUSH ON SPST</p>	 <p>SH-P-SMTS-102-C3 PUSH ON SPDT</p>
 <p>SH-P-SMTS-101-C4 PUSH ON SPST</p>	 <p>SH-P-SMTS-102-C4 PUSH ON SPDT</p>	 <p>SH-P-SMTS-102 WATER PROOF PUSH ON</p>	 <p>SH-P-SMTS-102-C4 WATER PROOF</p>
 <p>P-MTS-102 PUSH ON P-MTS-102 ON OFF</p>	 <p>P-MTS-202 PUSH ON P-MTS-202 ON OFF</p>	 <p>SH-P-MTS-102-C3 PUSH ON</p>	 <p>SH-P-MTS-102-C4 PUSH ON</p>
 <p>ZX-P-MTS-102 PUSH ON</p>	 <p>P-MTS-102+F22 CAP PUSH ON</p>	 <p>SH-SMTS-102 SPDT SH-SMTS-102-A2 PCB MOUNTING</p>	 <p>SH-SMTS-202 9DPDT SH-SMTS-202-A2 PCB MOUNTING</p>
 <p>SH-SMTS-102 WATER PROOF</p>	 <p>SH-SMTS-102-C4 WATER PROOF</p>	 <p>SH-MTS-102 / 103 WATER PROOF</p>	 <p>SH-P-MTS-102 WATER PROOF</p>
 <p>12MM SPDT</p> <p>SH-MTS-102 – ON-ON SH-MTS-103 – ON-OFF-ON SH-MTS-123 – (ON)OFF(ON)</p>		 <p>12MM DPDT</p> <p>SH-MTS-202 – ON-ON SH-MTS-203 – ON-OFF-ON SH-MTS-223 – (ON)OFF(ON)</p>	
 <p>P-MTS-102 ON-OFF 12MM</p>	 <p>P-MTS-202 ON-OFF 12MM</p>	 <p>P-MTS-102 PUSH ON 12MM</p>	 <p>P-MTS-302A ON-OFF P-MTS-302B PUSH ON</p>

MADE BY TAIWAN

 <p>SH-SMSTS-103 ON-OFF-ON</p>	 <p>SH-SMSTS-203 ON-OFF-ON</p>	 <p>SH-SMSTS-102-C4 ON-ON</p>	 <p>SH-SMSTS-103-C3 ON-OFF-ON</p>
 <p>SH-SMSTS-101-C3 ON-OFF</p>	 <p>SH-SMSTS-102-C3 ON-ON</p>	 <p>SH-SMSTS-202-C3 ON-ON</p>	 <p>SH-SMSTS-202-C4 ON-ON</p>
 <p>SH-MTS-102 SPDT</p>	 <p>SH-MTS-102-A2</p>	 <p>SH-MTS-102-C3 SH-MTS-103-C3</p>	 <p>SH-MTS-102-C4</p>
 <p>SH-MTS-202 DPDT</p>	 <p>SH-MTS-202-A2</p>	 <p>SH-MTS-202-C3</p>	 <p>SH-MTS-202-C4</p>
 <p>SH-SS-102-C3 SH-SS-103-C3</p>	 <p>SH-SS-12F13 2AMP/250V</p>	 <p>SH-MTS-302 ON-ON SH-MTS-303 ON-OFF-ON</p>	 <p>SH-MTS-402 ON-ON SH-MTS-403 ON-OFF-ON</p>
 <p>SH-SS-102 ON-ON SH-SS-103 ON-OFF-ON</p>	 <p>HARTMANN SX254</p>	 <p>KDC-A11</p>	 <p>KDC-A11-PCB TYPE</p>
 <p>FA2</p>	 <p>SW-3 SELF LOCK</p>	 <p>KDC-04 LOCK</p>	 <p>PWL-74</p>

PUSH BUTTONS

	<p>PBS-11A ON-OFF PBS-11B PUSH- ON PBS-11C PUSH -OFF 1AMP/250VAC RED / GREEN / BLACK</p>		<p>PBS-12A ON-OFF PBS-12B PUSH-ON 1AMP/250VAC RED / GREEN / BLACK</p>	
	<p>PBS-15-A ON-OFF PBS-15-B PUSH ON PBS-15-C PUSH OFF RED / GREEN / BLACK</p>		<p>PBS-20A ON-OFF PBS-20B PUSH ON RED / GREEN / BLACK</p>	
	<p>PBS-21A ON-OFF PBS-21B PUSH ON 1AMP/250VAC RED / GREEN / BLACK</p>		<p>PBS-22B PUSH ON PBS-22A ON-OFF 1AMP/250VAC RED / GREEN / BLACK</p>	
 <p>PBS-33B PUSH ON 12MM</p>	 <p>PB-10 A PUSH ON-OFF PB-10 B PUSH ON PB-10 C PUSH OFF</p>	 <p>KD-4N PUSH ON KD-4L PUSH ON-OFF</p>	 <p>KD-8N PUSH ON KD-8L ON-OFF</p>	
 <p>SP-318B – PUSH ON RED/BLACK/GREEN</p>	 <p>SP – 316B PUSH ON RED/BLACK/GREEN</p>	 <p>SP -312B PUSH ON RED/BLACK/GREEN</p>	 <p>SP-402 PUSH ON RED/BLACK/GREEN</p>	
 <p>CY-11A – ON-OFF CY-11B – PUSH ON 2V LED</p>	 <p>RS-16-11B PUSH ON RS-16-11A ON-OFF 2V LED</p>	 <p>PBS-25B – PUSH ON PBS-25C – PUSH OFF</p>	 <p>PBS-26B - PUSH ON PBS-26C-PUSH OFF</p>	
 <p>IPS-15A ON-OFF WITH LIGHT</p>	 <p>ZX-PS-14B PUSH ON SS-PS-14A ON-OFF</p>	 <p>PS-12B PUSH ON</p>	 <p>CS 218 PUSH ON</p>	 <p>IRS-201-8A ON-OFF IRS-201-8B PUSH ON</p>

GAME SWITCHES

			
GAME-1 – 23.5mm	GAME-4 – 24.5mm	GAME-3 – 23.5mm	CL-2021 63MM
			
GAME-5 – 23.5mm	GAME-6 – 23.5mm	GAME-7 – 24.5mm	CL-2012 100MM
			
CL-2033	CL-2045	PBS-001	CL-2024
			
CL-2050S 24MM	CL-2050P 24MM	CL-2053 28MM	CL-2052 28MM
			
CL-2038	CL-2042	CL-2043	CL-2046
			
CL-2040	CL-2041	CL-2048	CL-2020

Joystick

Miniature / Finger Joystick - Potentiometer Type



- Single, Dual & Triple Axis
- High Accuracy, Long Life
- Pushbutton(s) Models
- Many Handle Styles
- Spring Return to Center
- 3/16" Shaft Diameter
- Cost Effective



CV-4 JOYSTICK

CL-308

CL-316



CMRN-212
GO-ON 2WAY

CMRN-214
GO ON 4WAY

CMRN-222
AUTO RETURN 2WAY

CMRN-224
AUTO RETURN 4WAY



MINI JOYSTICK



SW-10



MINI JOYSTICK

KEY SWITCHES

			
PS-3002	TS6 WITHOUT LED	TS6 WITH LED	KS-1001
			
KS-1002	KS-1003	TL-6151	SPL-6
			
PB-6133 N / L	PB-6171 N	SP-86 - TOPAZ	SP-86B BIG
			
ZIPPY-P2	SPL-12	JB15-FP	JB15LPC-JC
			
TYPE-30 6X8MM KNOB	TYPE-30 10X10MM KNOB	TYPE-30 7MM KNOB	SH-P6 KEY
			
LT-15 TRF.	LT-15 RED	LT-19 TRF.	LT-19 RED
			
KSB-C	PB-11E01	CHERRY KEY	LT-15 AND LT-19 WITH 1 LED

ALL HEIGHT IS BASE TO TOP

6MM TACT SWITCHES















 <p>4.5MM X 4.5MM</p> <p>TC-204</p>	 <p>TC-2401</p>	 <p>R6-4.3H 2PIN</p>	 <p>R6-5H 2PIN</p>	 <p>R6-7H 2PIN</p>
 <p>R6-8H 2PIN</p>	 <p>R6-9.5H 2PIN</p>	 <p>TC-102H-13H</p>	 <p>R6-4.3H</p>	
 <p>R6-6H</p>		 <p>R6-8H</p>	 <p>R6-8.5H</p>	 <p>R6-9H</p>
 <p>R6-9.5H</p>	 <p>R6-10H</p>	 <p>R6-11H</p>	 <p>R6-12H</p>	 <p>R6-13H</p>
 <p>R6-15H</p>	 <p>TS6-16H</p>	 <p>R6-17H</p>	 <p>TS6-18H</p>	 <p>TS6-21H</p>

RIGHT ANGEL TACT SWITCHES

 <p>TC100-4.3H</p>	 <p>TC100-5H</p>	 <p>TC100-7H</p>	 <p>TC-100-8H</p>
 <p>TC100-9.5H</p>	 <p>TC100-11H</p>	 <p>TC100-13H</p>	 <p>TC100-15H</p>

ALL HEIGHT IS BASE TO TOP

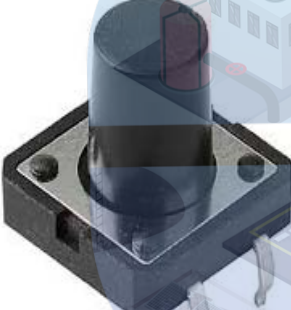
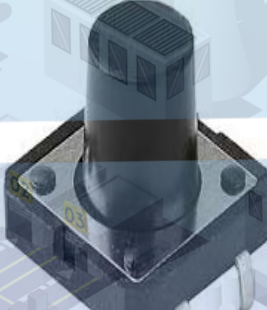
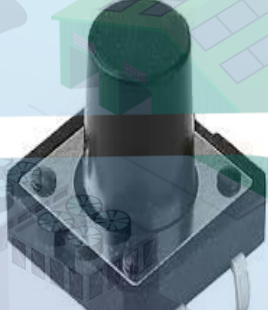
12MM TACT SWITCHES

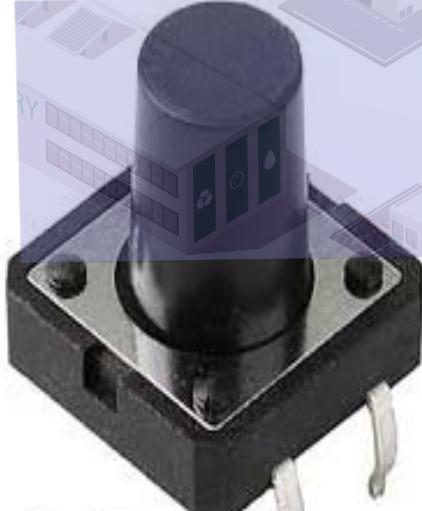
 <p>R12-4.3H</p>	 <p>R12-5H</p>	 <p>R12-6H</p>	 <p>R12-7H</p>
 <p>R12-8H</p>	 <p>R12-8.5H</p>	 <p>R12-9H</p>	 <p>R12-10H</p>
 <p>R12-11H</p>	 <p>R12-12H</p>	 <p>R12-13H</p>	 <p>R12-14H</p>
 <p>R12-15H</p>	 <p>R12-17H</p>	 <p>R12-18H</p>	 <p>R2-19H</p>
 <p>R12-21H</p>	 <p>R12-22H</p>		

TACT SWITCHES

				
TC-06204 4.5MM X 4.5MM	TC-06104- 4.3H	TC-06104-A 5H	TC-06104-E 7H	TC-06104-F 8H
				
TC-06104-C 9.5H	KFC-322	KFC-321	KFC-316-2.5MM	KFC-316-3.1MM
				
TC-12020A-01	DTSJW-66	TC-1157	TVEJ-13-P SMD	TC-12010-00
				
KFC-309 4.5X4.5MM	KFC-308 4.5X4.5MM	KFC-327 3X3MM	KFC-302 - 4.3H KFC-302- 5H	KFC-303- 4.3H KFC-303- 5H
				
KFC-301-WHITE	KFC-301-RED	KFC-329-NC	KFC-305	ALPS - SMT
				
KFC-332	KFC-300	KFC-300A	TC-26402	TC-26404
				
KFC-304	KFC-333-2.5	KFC-334	TC-16301	TC-16311
				
MOUSE SWITCH	AP8-13H	AP9-13H	AP10-13H	AP10-23H

PB PUSH SWITCHES

				
AP6-4.3H	AP6-5H	AP6-7H	AP6-9.5H	PB-50 LOCK PB-50 UNLOCK
				
PB-70 LOCK PB-70 UNLOCK	PB-80 LOCK PB-80 UNLOCK	PB-85 LOCK PB-85 UNLOCK	PB-0101 UNLOCK PB-0112 LOCK	ALPS PB-85 L
				
KAT-08-LOCK KAT-08 UNLOCK	PS-42E09 LOCK	PB-90 LOCK	KAT-11	PS-22E19N PS-22E19 LOCK
				
LTV-75 5.7MM / 6.5MM / 9MM / 11MM	DTR-8	DTS-8 SMD	DTR-12	DTS-12 SMD
				
ALPS-TC-121	ALPS-TC-121 R	ALPS-TC-121B	ALPS-TC-122	ALPS-TC-122 R
				
B3F-4000	B3F-4005	B3F-4050	B3F-4055	TC-12EF
				
TC-121	CS-122 CHINA	TC-122	TC-123	TC-12EB

DTS STEEL DOME TACT SWITCHES







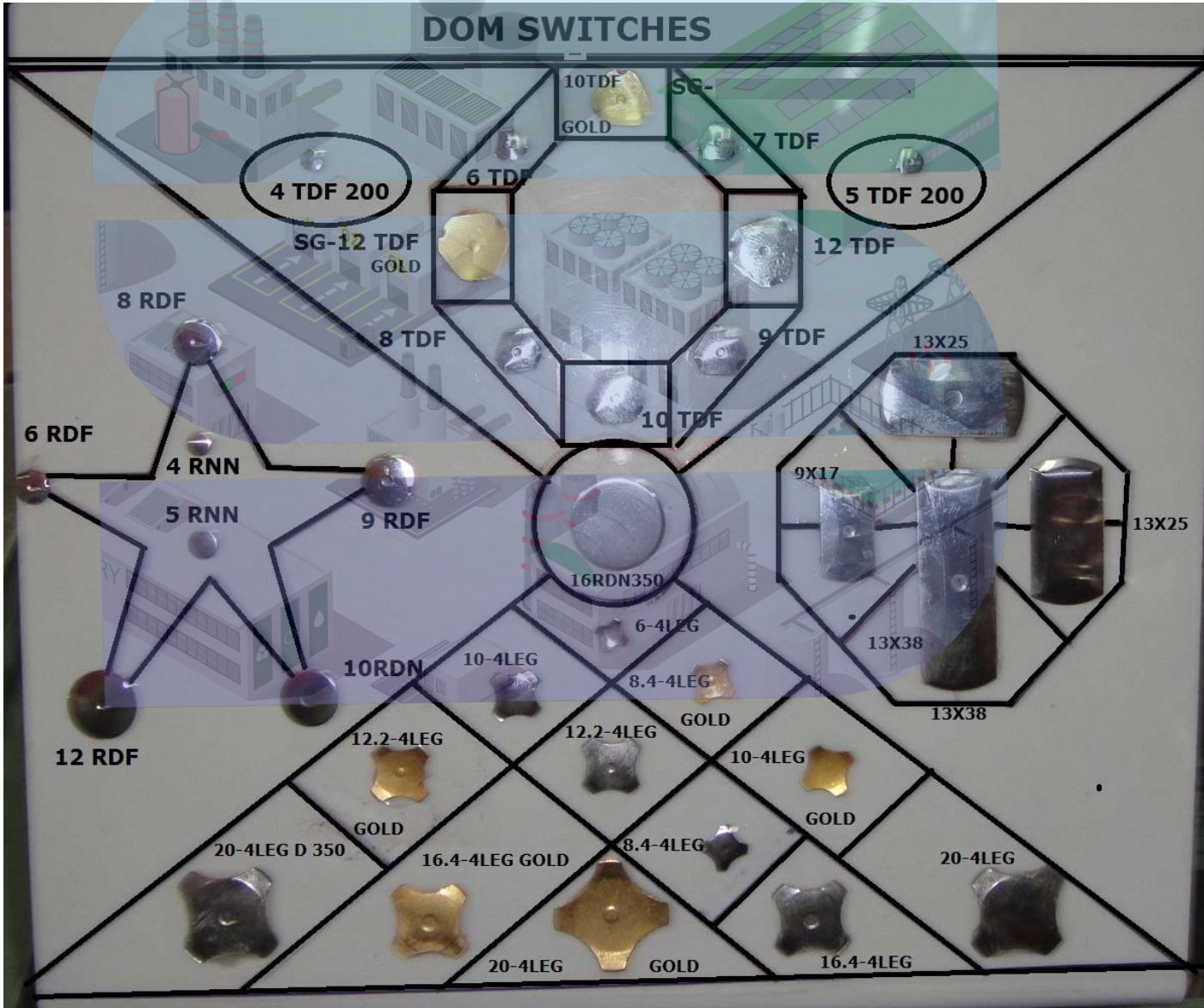









 <p>DTS-104-00 4.3H</p>	 <p>DTS-104A 5H</p>	 <p>DTS-104E 7H</p>	 <p>DTS-104C - 9.5H</p>
 <p>DTS--121</p>	 <p>DTS-12-8.5H</p>	 <p>TS-12- 4.3H SMD</p>	 <p>TS-12- 8.5H SMD</p>

DOME SWITCHES







DOM SWITCHES

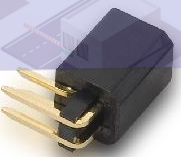
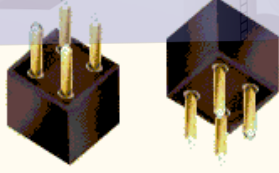

GÜNTHER REED SWITCHES

 52MM GOLD	 52MM-3PIN
 32MM-3PIN	 24MM GOLD
 20MM GOLD	 16MM GOLD
 14MM GOLD	 ORT-551 14MM - 3PIN
 10MM GOLD	 7MM GOLD
 27MM SILVER	 37MM SILVER
 50MM SILVER	 52MM GOLD - 5AMP
 36MM - 3PIN SILVER	 50MM - 3PIN SILVER

TILT SWITCHES / VIBRATION SENSOR AND SWITCH

 ROLL BALL SWITCH SW-520	 Tilt sensitive trigger switch R-512	 360*Vibration sensor VS-001	 VS-600 vibration sensor
 SW-200 ROLL BALL SWITCH	 SW-460 ROLL BALL SWITCH	 VS-420 vibration sensor	 VS-180 Vibration switch

SURFACE MOUNTED MAGNETIC CONTACTS



SP-1017-N.O
SP-1017A-N.C



SP-2012-N.O
SP-2012A-N.C



SP-3011C SHUTTER



SP-2022-N.O
SP-2022A-N.C



SP-2031 N.O
SP-2031C

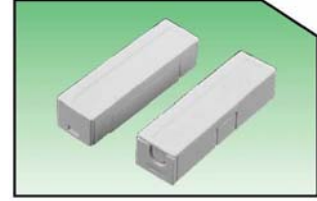

SP-2033 N.O

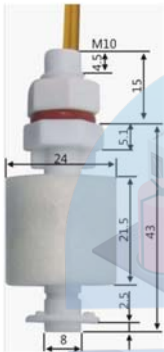

FS-43 FLOAT SWITCHES

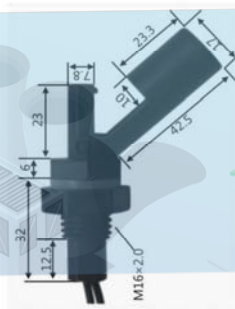

5C-45



SP-1013

<p>MN2525 (1/4" square rare earth magnet)</p>	<p>MN2550 (Dia. 1/4" x L 1/2" rare earth magnet)</p>	<p>MN2537 (Dia. 1/4" x L 3/4" rare earth magnet)</p>	<p>MN25100 (Dia. 1/4" x L 1" rare earth magnet)</p>
<p>MN3725 (Dia. 3/8" x L 1/4" rare earth magnet)</p>	<p>MN37375 (Dia. 3/8" x L 3/8" rare earth magnet)</p>	<p>MN3750 (Dia. 3/8" x L 1/2" rare earth magnet)</p>	<p>MN3775 (Dia. 3/8" x L 3/4" rare earth magnet)</p>
<p>MN5025 (Dia. 1/2" x L 1/4" rare earth magnet)</p>	<p>MN400 (Dia. 3/8" x L 1/2" Screw hole rare earth donut magnet)</p>	<p>MN600 (Dia. 3/5" Screw hole rare earth donut magnet)</p>	<p>MN123787 (1/8" x 3/8" x 7/8" flat rare earth magnet with VHB tape)</p>

BARE NEODYMIUM MAGNETS

DOOR SWITCHES-PRESS TO OFF TYPE

			
LTK-15	LTK-16	LTK-17	LTK-17-3PIN
			
LTK-18	LTK-19	LTK-20	LTK-22
			
DS-203	DS-204	SLIDING DOOR SWITCH DS-202	PS-56 2NO-2NC
			
PS-14 SPDT	PS-14 DPDT	BS-301	BS-303

DOOR RELEASE PUSH SWITCHES

86Lx86W x20T	86Lx28Wx20T	86Lx50Wx20T	55x20	86Lx86W
				
DB-5	DB-6	DB-4	DB-7	DB-1 N.O/N.C
				
DS-101		SP19		
				
		DS-144		

KEY SWITCHES

 <p>KLS-201M – 12MM 2PIN KLS-301M – 12MM 3PIN</p>	 <p>KS-01 – 12MM 2PIN</p>	 <p>KS-02 – 12MM 2PIN</p>	 <p>JT-NS 112 12MM</p>
 <p>S-1231 12MM ON-ON</p>	 <p>S-1333 12MM OFF-ON-ON</p>	 <p>S-1444 12MM OFF-ON- ON-ON</p>	 <p>S-1343 12MM ON-ON-ON</p>
 <p>JT-S 334B 16MM ON-OFF</p>	 <p>JT-S 331 16MM ON-ON</p>	 <p>JT-S 332 16MM OFF-ON</p>	 <p>JT-S 333 16MM OFF-ON-ON</p>
 <p>AN-KS-102A 19MM ON-OFF</p>	 <p>AN-KS-103 19MM ON-OFF-ON</p>	 <p>JT-KLS-123 19MM (ON) OFF (ON)</p>	 <p>JT-KLS-102A 19MM JT-KLS-102 AB 19MM</p>
 <p>KLS-102A KLS-102AB</p>		 <p>KLS-102A KLS-102AB</p>	
<p>AN-KLS-102A 19MM</p>		<p>AN-KLS-102AB 19MM</p>	

TORCH ON-OFF SWITCHES

 KAN-5 ON-OFF	 KAN8A ON-OFF	 KAN-9A ON-OFF 8A/250V	 KAN-13 ON-OFF
 KAN-15 ON-OFF	 KAN-1213 ON-ON-OFF	 KAN16-03E ON-ON-OFF	 KAN17-04 ON-ON-ON-OFF
 KAN-1812 ON-OFF	 KAN-1817 ON-OFF	 KAN-1820 ON-ON-OFF	 KAN-18 ON-OFF
 PS-11B03 ON-OFF	 PS-16C01 1P/6WAY ON-ON-ON-OFF	 KAN-29 ON-OFF	 PS-11B02 ON-OFF
 PB-03 ON-OFF	 PB-08 ON-OFF	 KAN-34 ON-OFF	 KAN-38 PUSH ON





















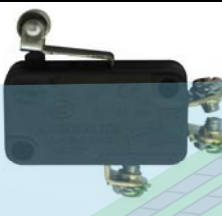

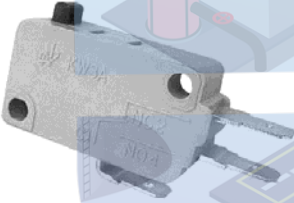

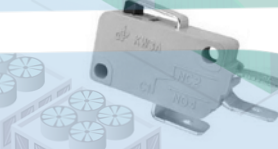

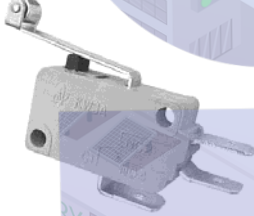
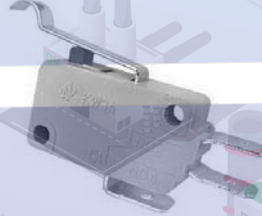
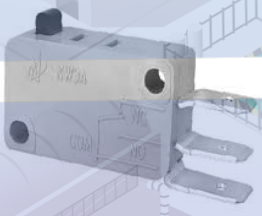
THUMB WHEEL SWITCHES

 KSA-5 14MM PUSH TYPE	 KSA-1 22MM PUSH TYPE	 KBP5 22MM-ROTED	 KBPM 30MM-ROTED
--	--	--	---



















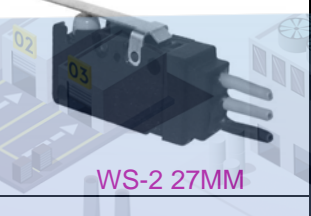

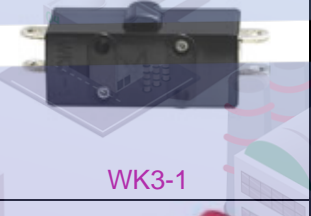
MICRO SWITCHES

			
MS-108	MS-118	MS-118- 18MM	MS-118-PROFILE
			
MS-118-ROLLER	MS-118 LEFT ANGEL	MS-118 RIGHT ANGEL	DS-37 DS-38L
			
MS-103 LONG LEG	MS-114 LONG LEG	MS-103 PCB TYPE	MS-114 PCB TYPE
			
MS-103 5AMP	MS-114 5AMP	MS-114-25MM	MS-114-ROLLER
			
MS-114-36MM	MS-114-44MM	MS-114-60MM	MS-114 R/A 14mm & 36mm
			
MS-114-PROFILE	MS-103 R/A	MS-103 L/A	MS-103 WATER PROOF
			
MS-114 WATER PROOF	WS1-103 WATER PROOF	WS1-114 WATER PROOF	WS1-114-ROLLER WATER PROOF

MICRO SWITCHES

			
MSW-01 SIDE 2 PIN N.O. 5AMP/250V	MSW-01 SIDE 2 PIN N.C. 5AMP/250V	MSW-01 SIDE 3 PIN 5AMP/250V	MSW-01 BASIC 5AMP/250V
			
MSW-02 - 27MM 5AMP/250V	MSW-02 - 60MM 5AMP/250V	MSW-03 13.5MM 5AMP/250V	MSW-03-25.6MM 5AMP/250V
			
MSW-01S 15A	MSW-02S 27MM 15A	MSW-03S 13.5MM 15A	MSW-03 S 25.6MM 15A
			
MSW-01 15AMP/250V	MSW-02-27MM 15AMP/250V	MSW-02-60MM 15AMP/250V	MSW-03-13.5MM 15AMP/250V
			
MSW-03-25.6MM 15AMP/250V	MSW-04-PROFILE 15AMP/250V	MSW-01 15AMP/250V SIDE 3PIN	MSW-01 15AMP/250V SIDE 2PIN N.C.
			
MSW-02 -F6B	MSW-02 -F7	MSW-02-F8	MSW-02-F9
			
MSW-02 -F14	MSW-02 -F15	MSW-02 -F16	MS10- 02-60MM 50GF

MICRO SWITCHES

			
MS1-BASIC 3AMP	MS1-PCB L/A	MS1-PCB R/A	MS1-02-27MM
			
MS1-02-60MM 3AMP	MS1-04-PROFILE 3AMP	MS1-03-13.5MM 3AMP	MS1-03-25.6MM 3AMP
			
MSW-01-2	MSW-04-27MM	MSW-06-13.5MM	MSW-06-25.6MM
			
WS-2 BASIC	WS-2 27MM	WS-2 60MM	WS-2 13.5MM
			
WS-2 25.6MM	WK3-1	WK1-1	JW2-11
			
DS-428	DS-628 - 2NO/2NC	FPB SWITCH	PB SWITCH
			
DB-1 LONG LEG	DB-2	ZIPPY COIN SWITCH	D2JW-OMRON

MICRO SWITCHES / LIMIT SWITCHES

			
CM-1300	CM-1305	CM-1306	CM-1307
			
CM-1308	CM-1309	CM-1701	CM-1702
			
CM-1703	CM-1704	CM-1705	CZ-7110
			
CZ-7120	CZ-7121	CZ-7124	CZ-7140
			
CZ-7141	CZ-7144	CZ-7166	CZ-7310
			
CZ-7311	CZ-7312	CZ-7100	TZ-6001
			
CPB-2 3A/250V	CBSP-330	CPB-3	CBSN-330

FOOT SWITCHES

 <p>CFS-01 PLASTIC BODY</p>	 <p>CFS-201 PLASTIC BODY</p>	 <p>CFS-1 IRON BODY</p>
 <p>CFS-3</p>	 <p>CFS-105 ON-OFF</p>	 <p>CFS-85</p>
 <p>CAS-012</p>	 <p>TZ-8104</p>	 <p>TZ-8107</p>
 <p>J TZ-8108</p>	 <p>TZ-8112</p>	 <p>KH-9011</p>
 <p>CLS-191</p>	 <p>CLS-101</p>	 <p>CLS-103</p>

SMD DIP SWITCHES 2.54MM PITCH



BOX DIP SWITCHES

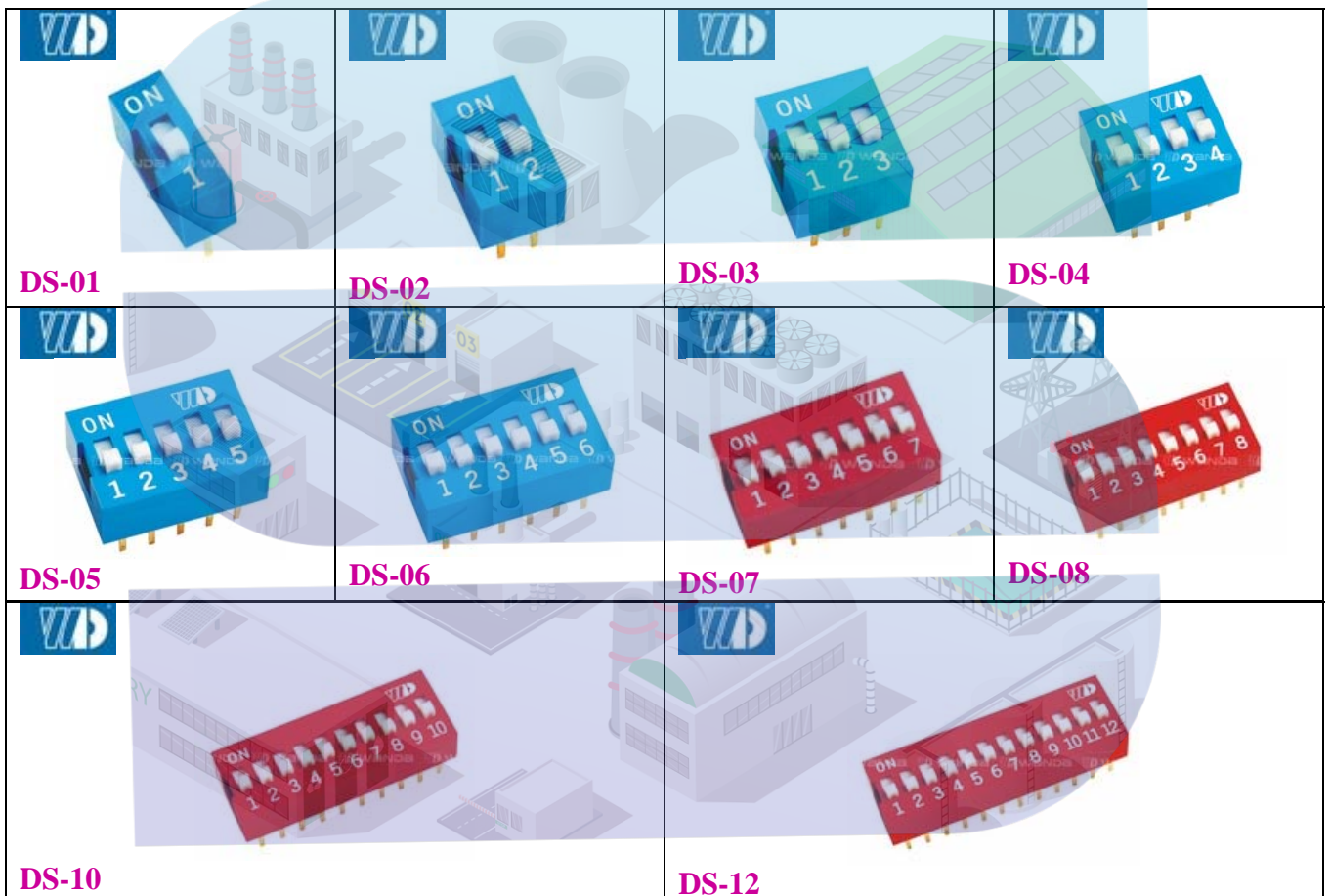

SMD DIP SWITCHES 1.27MM PITCH

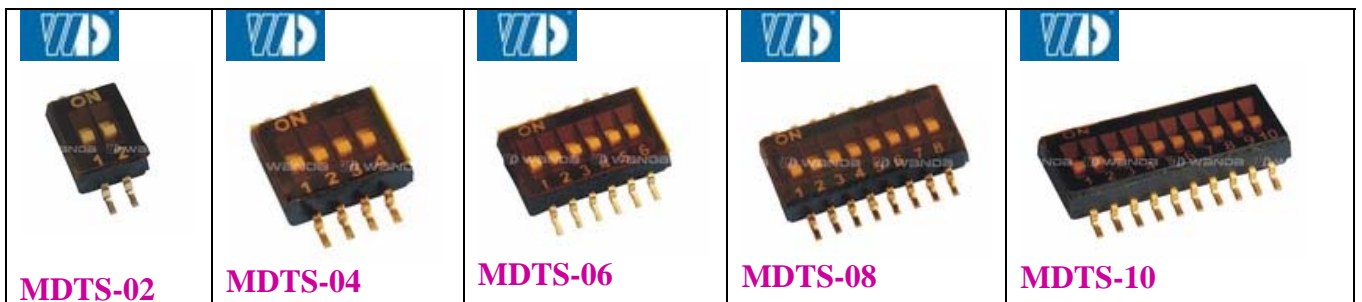

PIANO DIP SWITCHES

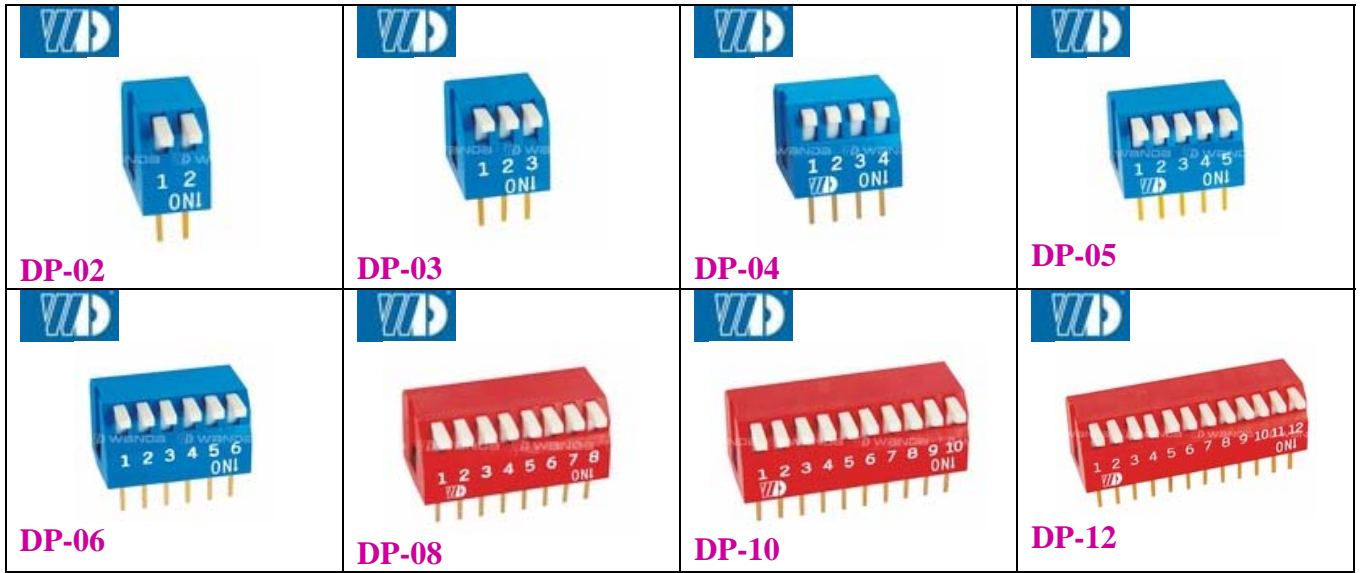



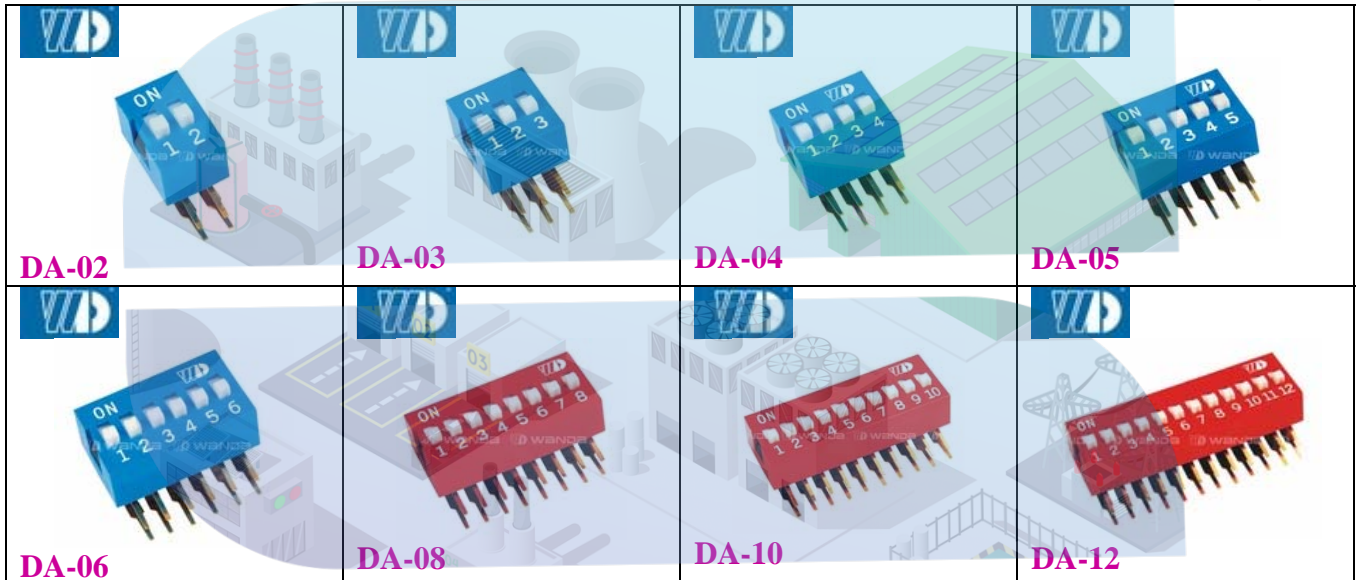

RIGHT ANGLE DIP SWITCHES

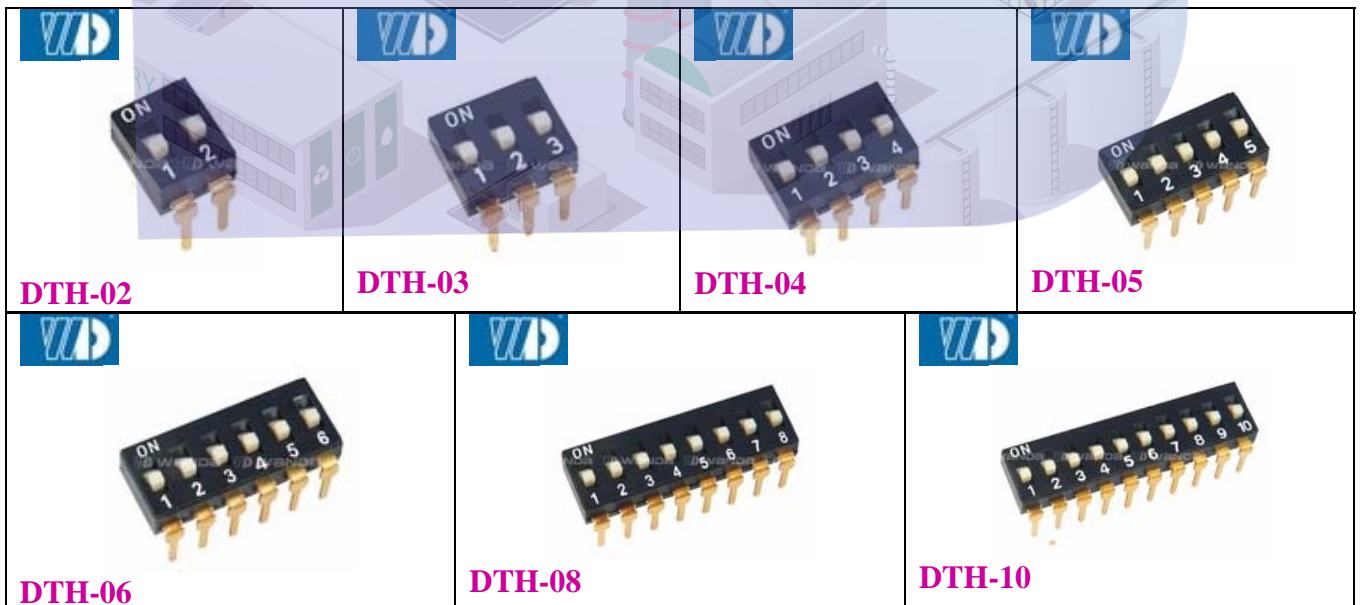





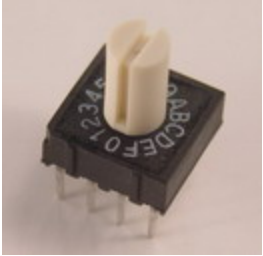
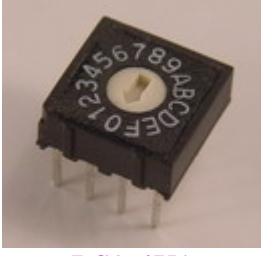
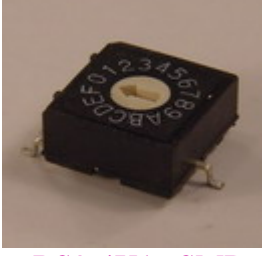



IC TYPE DIP SWITCHES



ROTARY DIP SWITCHES

			
RS9-3X3 RS16-3X3	RS9-3X3 / 2 SMD RS16-3X3 / 2 SMD	RS9-3X2 RS16-3X2	RS9-4X1 7.3MM RS16-4X1 7.3MM
			
RS9-4X1 RS16-4X1	RS9-4X1 SMD RS16-4X1 SMD	R/A RS9-3X3 R/A RS16-3X3	R/A RS9-3X3 R/A RS16-3X3 7.3MM KNOB

CIRKIT BREAKER SWITCHES

			
A-0708U 3A TO 20A	A-0709P ABR21-4A TO 30A	A0702 5A TO 20A	A-0710W 5A TO 20A
			
THERMOSTAT B-1009	A-0701M 5AMP TO 30AMP	A-0707X	THERMOSTAT 70°C / 80°C 16AMP

Computer power switches



KEY PAD

SIZE-81*69MM

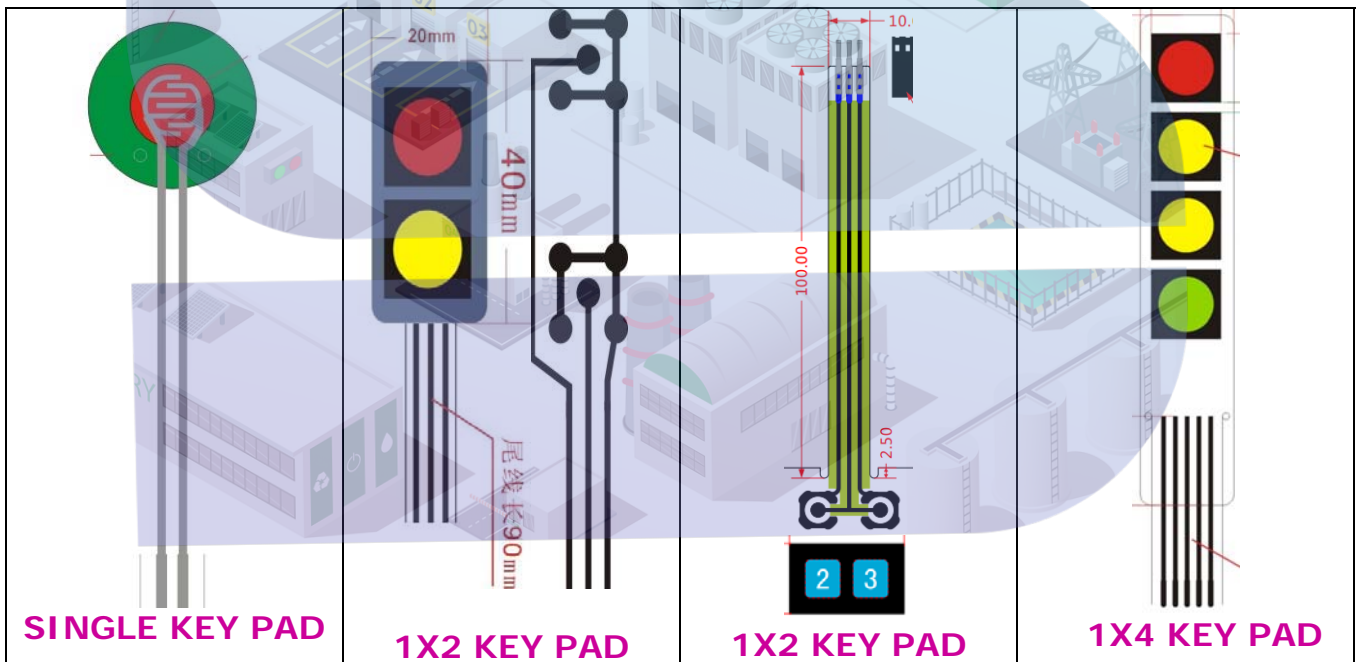
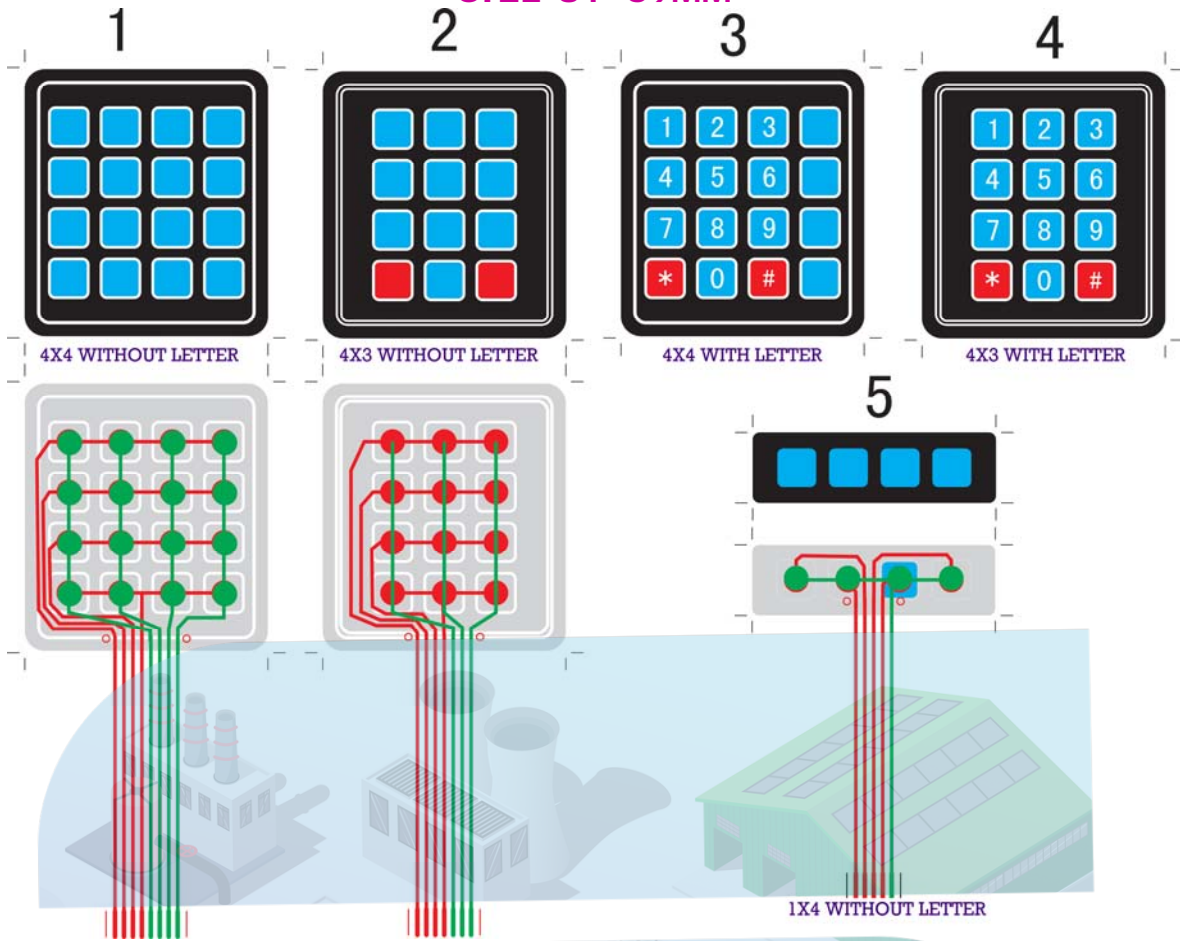











4X4 WITH PCB KEY PAD



3X4 WITH PCB KEY PAD

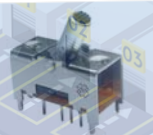
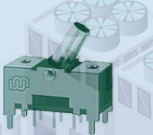















PUSH SWITCHES

 PS-22I48	 PS-12D01	 PS-12E05	 PS-22E50L	 PS-22F01
 PS-22F02-LOCK PS-22F03-N	 PS-22F04-LOCK PS-22F05-N	 PS-22F11	 PS-22F15	 PS-22F22
 PS-22F24	 PS-22F40	 PS-22L02	 PS-42L02	 PS-62L02
 PBS-22H01-N PBS-22H03-L	 PBS-22H04 SELF LOCK	 PBS-42H01-N PBS-42H03-L	 PBS-42H04	 GANG SWITCHES
 TS-22E02	 TS-23E02	 TS-22J02	 TS-42E02	 TS-43E02





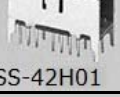
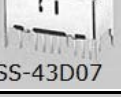





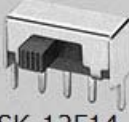



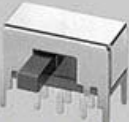







AC POWER SLIDE SWITCHES

 RL-202	 RL-203	 RL-204	 ACS-12L01
 WS-13H01	 ACS-13H01	 ACS-22I05	 ACS-23L05
 ACS-23L01	 ACS-24L01	 SL-13B	 SL-14B

SLIDE SWITCHES

 SS-12D00	 SS-12D01	 SS-12E17	 SS-12E21	 SS-12F02	 SS-12F08
 SS-12F13	 SS-12F14	 SS-12F15	 SS-12F17	 SS-12F23	 SS-12F24
 SS-12F25	 SS-12F26	 SS-12F44	 SS-12F47	 SS-12J11	 SS-13D03
 SS-13F03	 SS-13F11	 SS-16F03	 SS-22D03	 SS-22F04	 SS-22F05
 SS-22F06	 SS-22F08	 SS-22F12	 SS-22F17	 SS-22F25	 SS-22H07
 SS-22H03	 SS-22L15	 SS-22J01	 SS-22D03	 SS-23D07	 SS-23D08
 CS-23F25	 SS-22J12	 SS-23E04	 SS-23E08	 SS-23F02	 SS-23F03
 SS-23F08	 SS-23F09	 SS-23F19	 SS-23H02	 SS-23H03	 SS-24D03
 SS-24E01	 SS-24E08	 SS-24H02	 SS-24H08	 SS-42F01	 SS-43D01
 SS-42D02	 SS-42H01	 SS-43D07	 SS-44D04	 SS-62H01	 SS-63D01
 SS-63D05		 SS-64D01		 SS-83D01	

SIDE KNOB SLIDE SWITCHES

 SK-12D01	 SK-12F14	 SK-13D03	 SK-22D01	 SK-22D03
 SK-22F02	 SK-22F11	 SK-22F18	 SK-22H02	 SK-22H03
 SK-22H04	 SK-22J01	 SK-23D01	 SK-23D02	 SK-23D03
 SK-23H01	 SK-24F01	 SK-24H02	 SK-42D01	 SK-42F01
 SK-42H01	 SK-43D01	 SK-62H01	 SK-63D01	 SK-64D01

MINIATURE SLIDE SWITCHES

 MSK-12C02	 MSK-12D01	 MSS-12D05	 MSK-12D18	 MSK-12D18
 SSS-12L	 MSK-12D35	 MSS-13D19	 MSS-13D21	 MSS-23D18
 MSS-22C02	 MSS-22D18	 MSK-22D18	 MSK-22D48	 MSS-23C02











HOOK SWITCHES

 HS-2201	 HS-2201A	 HS-2201A
--	---	---

SOCKETS

				
EP SOCKET-3501	STM-3518-MONO	STM-3519-STEREO	STM-3507-STEREO	STM-3506-MONO
				
SP-6	DC-22A	STM-25084C	PJ-64019	DC-02
				
DC-05	DC-015	DC-017	AC-004	DC-019
				
DC-020	DC-021	DC-022	DCM-916-SMD	DC-960
				
AS-01	AS-02	AS-02-2	AS-03	AS-04
				
SS-AS-05	AS-06	AS-07	AS-07-2	AS-08
				
SP-722	SP-723	SP-724	SP-709	MICRO USB-922
				
USB-101S	USB-101A	USB-301B	USB-501	USB-502M

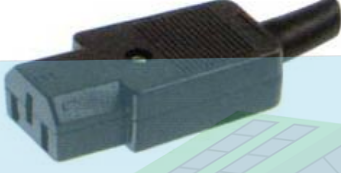
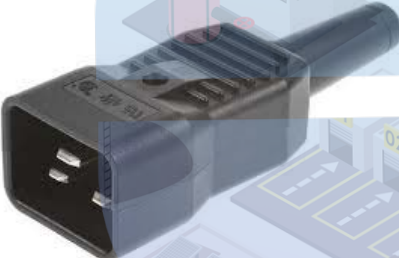



















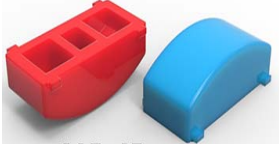













DC AND AC POWER JACK

 SP-22 0.7MM	 SP-23 1MM	 SP-28 1.3MM	 SP-47 1.7MM
 SP-24 2.5MM	 SP-25 2.1MM	 SP-02 3.5MM	 SP-03 2.5MM SP-04 3.5MM
 10AMP SP-1654		 10AMP SP-1655	
 16AMP SP-1656		 16AMP SP-1657	

TACT SWITCHES WITH CAP

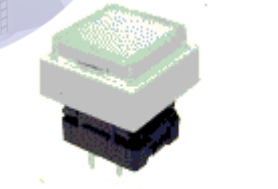
 PB-50L + CAP 6	 PB-80 + CAP 1	 PB-80 + CAP 6	 6MM+CAP-7
 TC122+CAP-4	 TC122+CAP-4 + HOUSING	 TC122+CAP-10	 TC122 + SH-CAP-4
 MTS-102 WITH RUBBER BOOT	 TC-2401 + CAP-30	 6MM + CAP-25	 TC-122+CAP-4B

SWITCHES CAP

 CAP-1	 CAP-2	 CAP-2A	 CAP-3
 CAP-4 10MM X 10MM	 CAP-4B	 CAP-4 + HOUSING	 SH-CAP-4 12MM X 12MM
 CAP-5	 CAP-6	 CAP-6B	 CAP-7
 CAP-7B	 CAP-8	 CAP-9	 CAP-10
 CAP-12A	 CAP-15	 CAP-19	 CAP-22
 CAP-25	 CAP-28	 CAP-30	 CAP-36
 CAP-4 HOUSING	 CAP FOR RS-12	 CAP FOR RS-101-8C	 CAP FOR RS-17
 CAP FOR IRS-101	 CAP FOR IRS-201	 KSC-G CAP	 KSC-CG CAP
 WB-CAP-17	 WPC-05	 TAIWAN 12MM RUBBER HOOD	 RUBBER HOOD

INDICATOR



Model Number	LAS1Y-D/Δ/▲/○	LAS1F-D/Δ/▲/○	LAS1J-D/Δ/▲/○
16MM LED NEON LAMP			
Remarks	12V / 24V / 230V	R G Y O B W	ONPOW

22MM PUSH BUTTONS

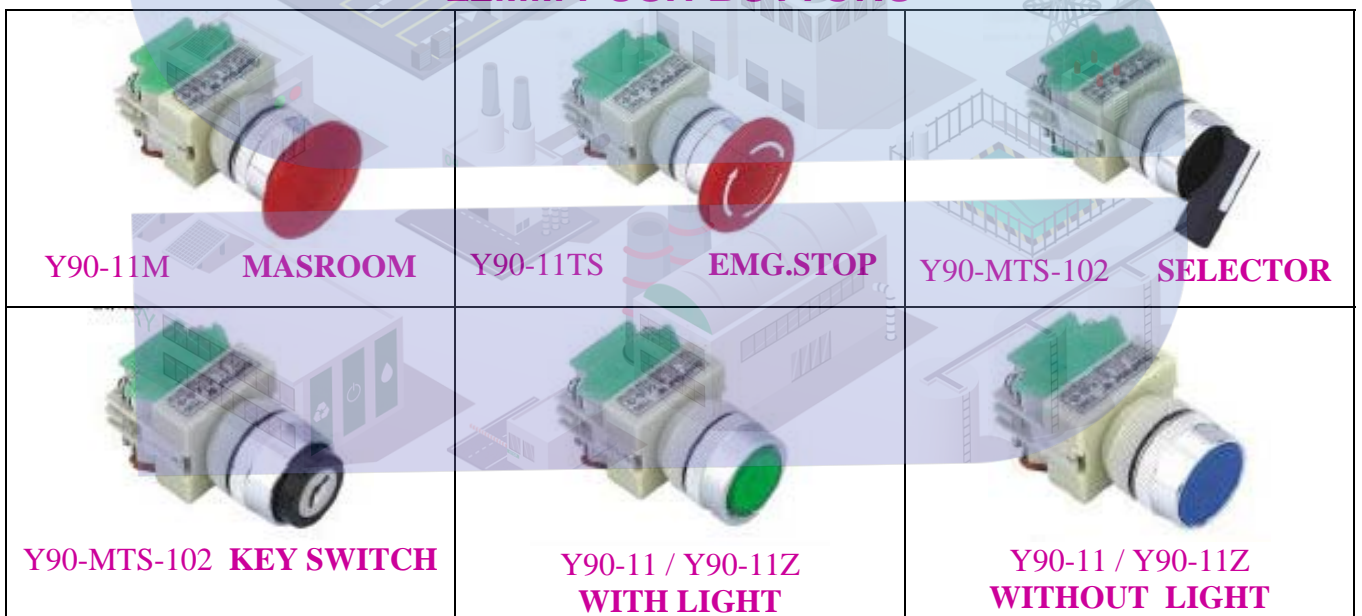

16MM FLASHING BUZZER



16MM MASROOM



22MM FLASHING BUZZER

8MM / 10MM / 12MM / 16MM SWITCHES

		
LAS1-AY 16MM	LAS1-AF 16MM	LAS1-AJ 16MM
		
LAS1-Y 16MM	LAS1-F 16MM	LAS1-J 16MM
		
LAS2-Y 12MM	LAS2-F 12MM	LAS2-J 12MM
		
LAS3-Y 10MM	LAS3-F 10MM	LAS3-J 10MM
		
LAS4-Y 8MM	LAS4-F 8MM	LAS4-J 8MM
		
AY-11TS 16MM	BY-11TS 16MM	BY-22TSB 2NO*2NC 16MM

				
LAS1-APY	LAS1-AWY	LAS1-APJ	LAS1-AWF	LAS1-APF

16MM ONPOW SWITCHES

 <p>SELECTOR AY-11-102</p>	 <p>SELECTOR AF-11-102</p>	 <p>SELECTOR AJ-11-102</p>
 <p>SELECTOR Y-11-102</p>	 <p>SELECTOR F-11-102</p>	 <p>SELECTOR J-11-102</p>
 <p>KEY-Y-11-102</p>	 <p>KEY-F-11-102</p>	 <p>KEY-J-11-102</p>
 <p>KEY-AY-11-102</p>	 <p>KEY-AF-11-102</p>	 <p>KEY-AJ-11-102</p>
 <p>LAS1-BY</p>	 <p>LAS1-BF</p>	 <p>LAS1-BJ</p>
 <p>SELECTOR BY-11-102</p>	 <p>SELECTOR BF-11-102</p>	 <p>SELEECTOR BJ-11-102</p>
 <p>KEY-BY-11-102</p>	 <p>KEY-BF-11-102</p>	 <p>KEY-BJ-11-102</p>

12MM SWITCHES

 <p>ONPOW 中国·红波按钮</p> <p>GQ-12AH-10E</p>	 <p>ONPOW 中国·红波按钮</p> <p>GQ-12AH</p>	<p>PUSH ON</p>  <p>ONPOW 中国·红波按钮</p> <p>GQ-12CH-10E</p>	<p>PUSH ON-OFF</p>  <p>ONPOW 中国·红波按钮</p> <p>GQ-12CH-10ZE</p>
 <p>ONPOW 中国·红波按钮</p> <p>GQ-10CH-10E</p>	 <p>ONPOW 中国·红波按钮</p> <p>GQ-10CH-10ZE</p>	 <p>ONPOW 中国·红波按钮</p> <p>GQ16H-10E</p>	 <p>ONPOW</p> <p>GQ12B-10D</p>

 <p>X5-IRS-201 ON-OFF</p>	 <p>X5-IRS-202 ON-ON</p>	 <p>X5-IRS-203 ON-OFF-ON</p>	 <p>X5-IRS-223 (ON)-OFF-(ON)</p>
 <p>E-T-A 3120-F321-20AMP</p>	 <p>E-T-A 3120-F321-8AMP</p>	 <p>K3AA2EAA</p>	 <p>TA45 16.5AMP</p>



JB-03



FIRE SWITCH



IRS-21



ROTARY SWITCHES

			
MR-113	MR-118	SR-112	SR-0206
			
SR-25 1P/3WAY	SR-25 1P/12WAY	SR-25 2P/4WAY	SR-25 2P/6WAY
			
WB-1P / 12WAY	WB-2P / 12WAY	WB-2P / 6WAY	WB-16P / 2WAY

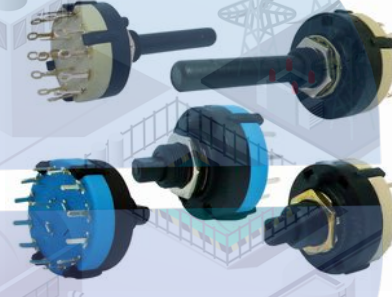
Switch point

	
SR-26	SR-26

PROXIMITY SENSOR

		
8MM-1MM DC-6 - 30V	12MM-2MM DC-6 - 30V	12MM-4MM DC-6 - 30V
		
18MM-5MM DC-6 - 30V	18MM-8MM DC-6 - 30V	30MM-8M DC-6 - 30V



12MM-GQ-12B



12MM-GQ-12B-10J



12MM-GQ-12B-N



12MM-GQ-12S-10J



16MM-GQ-16H



19MM-GQ-19B



LAS2-GQ-16MM



LAS1-AGQ-19MM



GQ-22MM/25mm



BUZZER



19MM SELECTOR



19MM KEY

PIEZO & TOUCH SWITCHES IP68

PIEZO & TOUCH SWITCHES IP68