

FLEXIBLE SPIRAL CONDUITS METAL

TECHNICAL DETAILS

Material	: Galvanised steel
Certificates	: ROHS, CE
Protection class	: IP40
Temperature range	: -25 °C +120 °C

Properties

High impact strength
High abrasion resistance
Halogen free
Low fire hazard
Self-extinguishing
Full-shrink packing

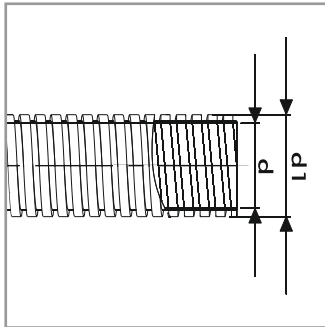

PRODUCT RANGE OVERVIEW

Code	Size	d mm.	d1 mm.	Roll Length mt.
OCGS 7	-	7,5	10,5	50
OCGS 9	1/4"	9	12	50
OCGS 11	3/8"	11	14	50
OCGS 13	3/8"	13	16	50
OCGS 14	-	14	17	50
OCGS 16	1/2"	16	19	50
OCGS 18	-	18	21	50
OCGS 21	3/4"	21	24	50
OCGS 26	1"	26	30	25
OCGS 29	-	29	33	25
OCGS 32	-	32	36	25
OCGS 35	1 1/4"	35	39	25
OCGS 37	-	37	41	25
OCGS 40	1 1/2"	40	44	25
OCGS 42	-	42	46	25
OCGS 45	-	45	49	25
OCGS 51	2"	51	55	25
OCGS 63	2 1/2"	63	67	15
OCGS 75	3"	75	80	15

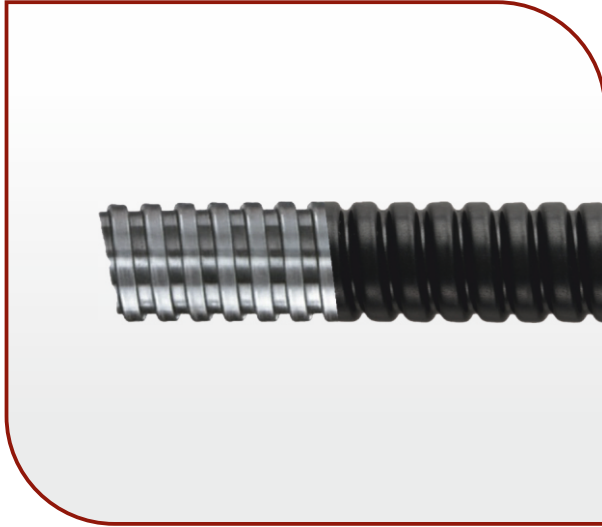
FLEXIBLE SPIRAL CONDUITS PVC COATED METAL

TECHNICAL DETAILS

Material	: Galvanised steel PVC coated
Certificates	: ROHS, CE
Color	: Black (RAL9005) Other color versions are available on request with reasonable qty.
Protection class	: IP54, IP65
Temperature range	: - 25 °C + 90 °C

Properties

High fatigue life
High impact strength
Self-extinguishing
High UV resistance (black) (on request)
Full-shrink packing

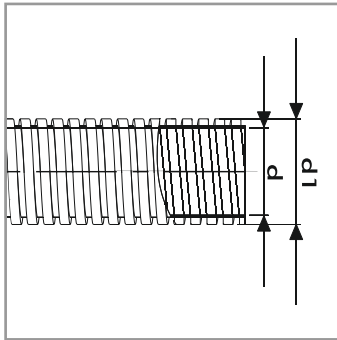

PRODUCT RANGE OVERVIEW

Code	Size	d mm.	d1 mm.	Roll Length mt.
OPCGS 7	-	7,5	11,5	50
OPCGS 9	1/4"	9	13	50
OPCGS 11	3/8"	11	15	50
OPCGS 13	3/8"	13	16,5	50
OPCGS 14	-	14	18	50
OPCGS 16	1/2"	16	20	50
OPCGS 18	-	18	22	50
OPCGS 21	3/4"	21	25	50
OPCGS 26	1"	26	31	25
OPCGS 29	-	29	34	25
OPCGS 32	-	32	37	25
OPCGS 35	1 1/4"	35	40	25
OPCGS 37	-	37	42	25
OPCGS 40	1 1/2"	40	45	25
OPCGS 42	-	42	47	25
OPCGS 45	-	45	50	25
OPCGS 51	2"	51	56	25
OPCGS 63	2 1/2"	63	68	15
OPCGS 75	3"	75	83	15
OPCGS 100	4"	100	107	10

TACFLEX TPV COATED METAL FLEXIBLE CONDUITS

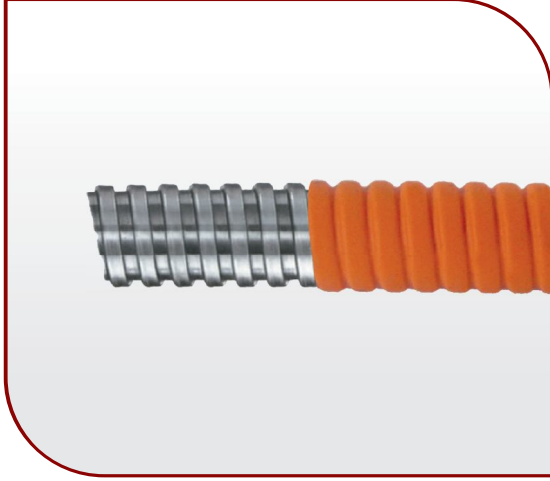
FLEXIBLE SPIRAL CONDUITS TPV COATED

TECHNICAL DETAILS

Material	: Galvanised steel TPV coated
Certificates	: ROHS, CE, PT, TUV, Halojen Free
Protection class	: IP54, IP65
Temperature range	: -20 °C +100 °C

Properties

High impact strength
Halogen free
Low fire hazard
Self-extinguishing
High UV resistance (black)
Full-shrink packing

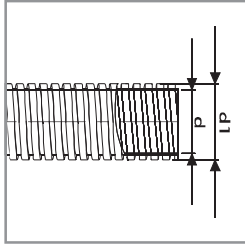

HALOGEN FREE KAPLI METAL SİRİAL BORULAR

Hammaddesi	: Galvaniz & kalay kaplı sac
Renk	: Turuncu / siyah
Kaplama	: TPV
Sürekli ısıya direnci	: -20 °C + 100 °C
Özellik	: Halogen free Alev iletmez UV dayanımlı

PRODUCT RANGE OVERVIEW

Code	Size	d mm.	d1 mm.	Roll Length mt.
OPCHF 7	-	7,5	11,5	50
OPCHF 9	1/4"	9	13	50
OPCHF 11	3/8"	11	115	50
OPCHF 13	3/8"	13	16,5	50
OPCHF 14	-	14	18	50
OPCHF 16	1/2"	16	20	50
OPCHF 18	-	18	22	50
OPCHF 21	3/4"	21	25	50
OPCHF 26	1"	26	31	25
OPCHF 29	-	29	34	25
OPCHF 32	-	32	37	25
OPCHF 35	1 1/4"	35	40	25
OPCHF 37	-	37	42	25
OPCHF 40	1 1/2"	40	45	25
OPCHF 42	-	42	47	25
OPCHF 45	-	45	50	25
OPCHF 51	2"	51	56	25
OPCHF 63	2 1/2"	63	68	25
OPCHF 75	3"	75	83	25

Halogen free

TACFLEX FLEXIBLE CONDUITS - Steel wire over braiding



tacflex

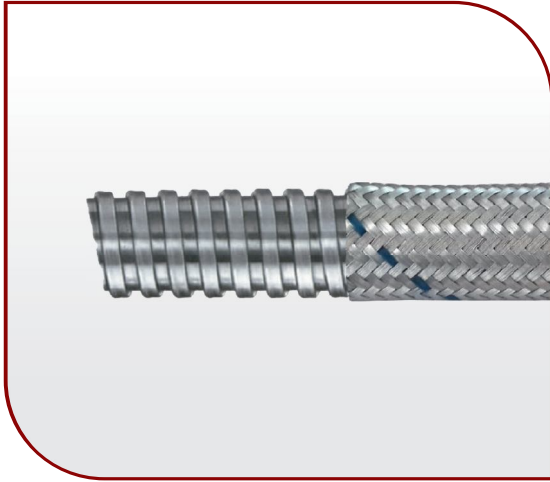

FLEXIBLE SPIRAL CONDUITS STEEL WIRE OVER BRAIDING

TECHNICAL DETAILS

Material : Galvanised steel galv. steel overbraid
 Certificates : ROHS, CE, PT, TUV
 * SS overbraid version is available on request
 Protection class : IP40
 Temperature range : -100 °C +300 °C

Properties

High impact strength
 Halogen free
 Low fire hazard
 Self-extinguishing
 High abrasion resistance
 EMC screening
 Full-shrink packing

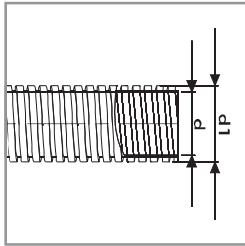

ÇELİK TEL ÖRGÜLÜ METAL SİRAL BORULAR

Hammaddesi : Galvaniz & kalay kaplı sac
 Örgü kaplaması : Galvaniz / Paslanmaz çelik
 Sürekli ısıya direnci : -100 °C + 300 °C
 Emc screen özelliği

PRODUCT RANGE OVERVIEW

Code	Size	d mm.	d1 mm.	Roll Length mt.
CTS 9	1/4"	9	14	50
CTS 10	1/4"	10	15	50
CTS 11	3/8"	11	16	50
CTS 13	3/8"	13	17,5	50
CTS 16	1/2"	16	21	50
CTS 21	3/4"	21	26	50
CTS 26	1"	26	32	25
CTS 35	1 1/4"	35	41	25
CTS 40	1 1/2"	40	46	25
CTS 51	2"	51	57	25

TACFLEX LIQUID TIGHT FLEXIBLE CONDUITS



FLEXIBLE SPIRAL CONDUITS STEEL WIRE OVER BRAIDING LIQUID TIGHT

TECHNICAL DETAILS

Material	: Galvanised steel PVC coated steel wire over braiding liquid tight
Certificates	: ROHS, CE, PT, TUV
Color	: Black Other color versions are available on request with reasonable qty.
Protection class	: IP66
Temperature range	: -20 °C + 100 °C

Properties

High impact strength
Self-extinguishing
High UV resistance (black)
High abrasion resistance
EMC screen

AĞIR HİZMET ÇELİK TEL ÖRGÜLÜ PVC KAPLI METAL SİRİAL BORULAR

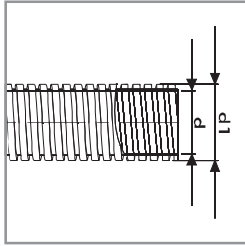

Hammaddesi	: Galvaniz & kalay kaplı sac
1. Kaplama	: PVC
2. Kaplama	: Galvaniz / paslanmaz çelik
Sürekli ısıya direnci	: -20 °C + 100 °C
Özellik	: Alev iletmez UV dayanımlı Ağır hizmet tipi Kırılmayı önleyici mühür ipli EMC screen özelliği
Renk	: Gri / Siyah

PRODUCT RANGE OVERVIEW

Code	Size	d mm.		d1 mm.		Roll Length mt.
LGTCT 10	1/4"	10,3	10,5	17,5	18	30
LGTCT 12	3/8"	12,3	12,7	19,5	20	30
LGTCT 16	1/2"	15,5	16,3	22,8	23,4	30
LGTCT 21	3/4"	20,9	21,3	28,2	28,5	30
LGTCT 27	1"	26	27	34,7	35,3	30
LGTCT 35	1 1/4"	35	35,5	42,5	44	15
LGTCT 40	1 1/2"	40	40,5	49,3	50,2	15
LGTCT 51	2"	51,5	51,9	61,5	62	15
LGTCT 63	2 1/2"	63	63,5	74,2	75	7,5
LGTCT 78	3"	78	78,5	90	100,5	7,5
LGTCT 91	3 1/2"	88,9	89,9	102,6	103,6	7,5
LGTCT 102	4"	101,6	102,6	113,3	116,3	7,5

TACFLEX LIQUID TIGHT FLEXIBLE CONDUITS





FLEXIBLE SPIRAL CONDUITS LIQUID TIGHT

TECHNICAL DETAILS

Material	: Galvanised steel PVC coated liquid tight
Certificates	: ROHS, CE, PT, TUV
Color	: Black Other color versions are available on request with reasonable qty.
Protection class	: IP66
Temperature range	: -20 °C +105 °C

Properties

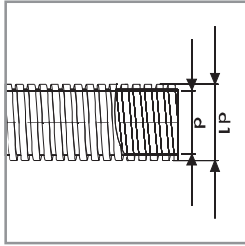
High impact strength
Self-extinguishing
High UV resistance (black)



AĞIR HİZMET PVC KAPLI METAL SİRİRAL BORULAR

Hammaddesi	: Galvaniz & kalay kaplı sac
Kaplama	: PVC
Sürekli ısıya direnci	: -20 °C +105 °C
Özellik	: Alev iletmez UV dayanımlı Ağır hizmet tipi Kırılmayı önleyici mühür ipli
Renk	: Gri / Siyah

PRODUCT RANGE OVERVIEW

Code	Size	d mm.		d1 mm.		Roll Length mt.
LGT 10	1/4"	10,3	10,5	15,5	16	30
LGT 12	3/8"	12,3	12,7	17,5	18	30
LGT 16	1/2"	15,5	16,3	20,8	21,4	30
LGT 21	3/4"	20,9	21,3	26,2	26,5	30
LGT 27	1"	26	27	32,7	33,3	30
LGT 35	1 1/4"	35	35,5	41,5	42	15
LGT 40	1 1/2"	40	40,5	47,3	48,2	15
LGT 51	2"	51,5	51,9	59,5	60	15
LGT 63	2 1/2"	63	63,5	72,2	73	7,5
LGT 78	3"	78	78,5	88	88,5	7,5
LGT 91	3 1/2"	88,9	89,9	100,6	101,6	7,5
LGT 102	4"	101,6	102,6	113,3	114,3	7,5

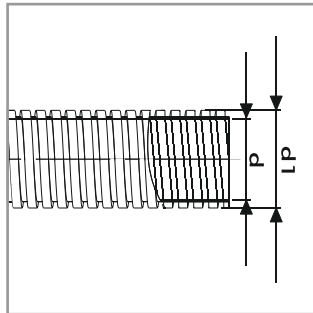
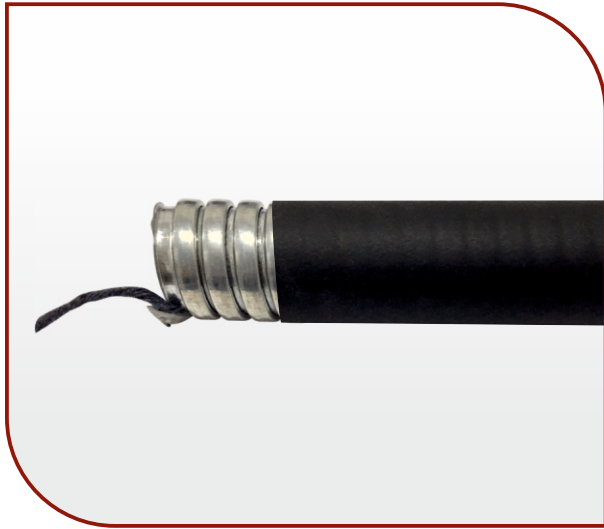
FLEXIBLE SPIRAL CONDUITS LIQUID TIGHT HALOGEN FREE

TECHNICAL DETAILS

Material	: Galvanised steel TPV coated liquid tight
Certificates	: ROHS, CE, Halogen Free
Color	: Black Other color versions are available on request with reasonable qty.
Protection class	: IP66
Temperature range	: -40 °C +100 °C

Properties

High impact strength
Self-extinguishing
High UV resistance (black) (on request)
Halogen free
Low fire hazard
Apply with either LSPR-LSRDP Ex-MLSR type conduit fittings

Code	Size	d mm.		d1 mm.		Roll Length mt.
LGTHF 10	1/4"	10,3	10,5	15,5	16	30
LGTHF 12	3/8"	12,3	12,7	17,5	18	30
LGTHF 16	1/2"	15,5	16,3	20,8	21,4	30
LGTHF 21	3/4"	20,9	21,3	26,2	26,5	30
LGTHF 27	1"	26	27	32,7	33,3	30
LGTHF 35	1 1/4"	35	35,5	41,5	42	15
LGTHF 40	1 1/2"	40	40,5	47,3	48,2	15
LGTHF 51	2"	51,5	51,9	59,5	60	15
LGTHF 63	2 1/2"	63	63,5	72,2	73	7,5
LGTHF 78	3"	78	78,5	88	88,5	7,5
LGTHF 91	3 1/2"	88,9	89,9	100,6	101,6	7,5
LGTHF 102	4"	101,6	102,6	113,3	114,3	7,5

TACFLEX FLEXIBLE CONDUIT FITTINGS



FLEXIBLE SPIRAL CONDUIT FITTINGS LIQUID TIGHT FIXED & SWIVEL

TECHNICAL DETAILS

Material

Cap nut	: Brass with nickel plated
Ring	: PA6
Ferrule	: Aluminium / Galvanised
Gland body	: Brass with nickel plated
O-ring	: NBR
Connection thread	: Metric (EN60423) / PG (DIN 40430)
Protection class	: IP67
Certificates	: ROHS, CE, PT, TUV
Temperature range	: -45 °C +105 °C

Properties

Easy to assemble
Fixed or swivel body versions
Apply with either LGT or CTS, CTPS type conduits

AĞIR HİZMET SİRAL BORU RAKORU SABİT & DÖNER DIŞ

Hammaddesi	: Pirinç, nikel kaplı
Bağlantı dişi M	: EN 60423
Bağlantı dişi PG	: DIN 40430
Koruma sınıfı	: IP67
O-ring	: Nitril kauçuk
Uygun spiral	: LGT-CTS-CTPS

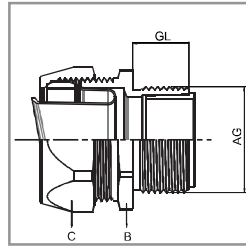
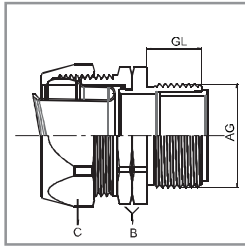

FIXED/SWIVEL BODY

PRODUCT RANGE OVERVIEW

Code		AG Thread		Spiral	GL	B	C
PG	Metric	PG	Metric	Measure	mm.	mm.	mm.
LSRP 00	LSRM 00	PG 7	M 12 x 1,5	LGT10 - 1/4"	10	20	22
LSRP 1A	LSRM 1A	PG 9	M 16 x 1,5	LGT10 - 1/4"	10	20	22
LSRP 01	LSRM 01	PG 11	M 16 x 1,5	LGT13 - 3/8"	11,5	24	26
LSRP 2A	-	PG 13,5	-	LGT16 - 1/2"	13	27	29
LSRP 02	LSRM 02	PG 16	M 20 x 1,5	LGT16 - 1/2"	13	27	29
LSRP 03	LSRM 03	PG 21	M 25 x 1,5	LGT21 - 3/4"	15	33	35
LSRP 04	LSRM 04	PG 29	M 32 x 1,5	LGT27 - 1"	15	43	45
LSRP 05	LSRM 05	PG 36	M 40 x 1,5	LGT35 - 1 1/4"	16	52	54
LSRP 06	LSRM 06	PG 42	M 50 x 1,5	LGT40 - 1 1/2"	18	60	63
LSRP 07	LSRM 07	PG 48	M 63 x 1,5	LGT51 - 2"	20	74	77
	LSRM 08		M 72 x 1,5	LGT63 - 2 1/2"	20	90	90
	LSRM 09		M 75 x 1,5	LGT78 - 3"	24	105	110
	LSRM 10		M 100 x 2	LGT102 - 4"	30	136	140
SWIVEL BODY							
LSRDP 00	LSRDM 00	PG 7	M 12 x 1,5	LGT10 - 1/4"	10	20	22
LSRDP 1A	LSRDM 1A	PG 9	M 16 x 1,5	LGT10 - 1/4"	10	20	22
LSRDP 01	LSRDM 01	PG 11	M 16 x 1,5	LGT13 - 3/8"	11,5	24	26
LSRDP 2A	-	PG 13,5	-	LGT16 - 1/2"	13	27	29
LSRDP 02	LSRDM 02	PG 16	M 20 x 1,5	LGT16 - 1/2"	13	27	29
LSRDP 03	LSRDM 03	PG 21	M 25 x 1,5	LGT21 - 3/4"	15	33	35
LSRDP 04	LSRDM 04	PG 29	M 32 x 1,5	LGT27 - 1"	15	43	45
LSRDP 05	LSRDM 05	PG 36	M 40 x 1,5	LGT35 - 1 1/4"	16	52	54
LSRDP 06	LSRDM 06	PG 42	M 50 x 1,5	LGT40 - 1 1/2"	18	60	63
LSRDP 07	LSRDM 07	PG 48	M 63 x 1,5	LGT51 - 2"	20	74	77
	LSRDM 08		M 72 x 1,5	LGT63 - 2 1/2"	20	90	90
	LSRDM 09		M 75 x 1,5	LGT78 - 3"	24	105	110
	LSRDM 10		M 100 x 2	LGT102 - 4"	30	136	140

TACFLEX FLEXIBLE CONDUIT FITTINGS



FLEXIBLE SPIRAL CONDUIT FITTINGS NPT LIQUID TIGHT FIXED & SWIVEL

TECHNICAL DETAILS

Material

Cap nut	: Brass with nickel plated
Ring	: PA6
Ferrule	: Aluminium / Galvanised
Gland body	: Brass with nickel plated
O-ring	: NBR
Connection thread	: NPT ANSI B1.20.1
Protection class	: IP67
Certificates	: Certificates
Temperature range	: -45 °C +105 °C

Properties

Easy to assemble
Fixed or swivel body versions
Apply with either LGT or CTS, CTPS type conduits

AĞIR HİZMET SİRAL BORU RAKORU SABİT & DÖNER DİŞ

Hammaddesi	: Pirinç, nikel kaplı
Bağlantı dişi NPT	: NPT ANSI B1.20.1
Koruma sınıfı	: IP67
O-ring	: Nitril kauçuk
Uygun spiral	: LGT-CTS-CTPS

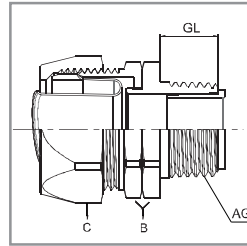
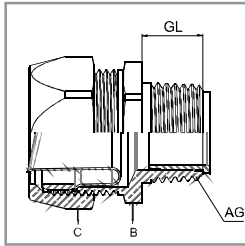

NPT / FIXED/SWIVEL BODY

Code	AG Thread Npt	Spiral Measure	GL mm.	B mm.	C mm.
LSRN 00	1/4"	LGT10 - 1/4"	10	20	22
LSRN 01	3/8"	LGT13 - 3/8"	11,5	24	26
LSRN 02	1/2"	LGT16 - 1/2"	13	27	29
LSRN 03	3/4"	LGT21 - 3/4"	15	33	35
LSRN 04	1"	LGT27 - 1"	15	43	45
LSRN 05	1 1/4"	LGT35 - 1 1/4"	16	52	54
LSRN 06	1 1/2"	LGT40 - 1 1/2"	18	60	63
LSRN 07	2"	LGT51 - 2"	20	74	77
LSRN 08	2 1/2"	LGT63 - 2 1/2"	20	90	90
LSRN 09	3"	LGT78 - 3"	24	105	110
LSRN 10	4"	LGT102 - 4"	30	136	140
SWIVEL BODY					
LSRDN 00	1/4"	LGT10 - 1/4"	10	20	22
LSRDN 01	3/8"	LGT13 - 3/8"	11,5	24	26
LSRDN 02	1/2"	LGT16 - 1/2"	13	27	29
LSRDN 03	3/4"	LGT21 - 3/4"	15	33	35
LSRDN 04	1"	LGT27 - 1"	15	43	45
LSRDN 05	1 1/4"	LGT35 - 1 1/4"	16	52	54
LSRDN 06	1 1/2"	LGT40 - 1 1/2"	18	60	63
LSRDN 07	2"	LGT51 - 2"	20	74	77
LSRDN 08	2 1/2"	LGT63 - 2 1/2"	20	90	90
LSRDN 09	3"	LGT78 - 3"	24	105	110
LSRDN 10	4"	LGT102 - 4"	30	136	140

PRODUCT RANGE OVERVIEW

IP67

TACFLEX FLEXIBLE CONDUIT FITTINGS



FLEXIBLE SPIRAL CONDUIT FITTINGS LIQUID TIGHT FEMALE TYPE FIXED & SWIVEL

TECHNICAL DETAILS

Material

- Cap nut : Brass with nickel plated
- Ring : PA6
- Ferrule : Aluminium / Galvanised
- Gland body : Brass with nickel plated
- O-ring : NBR
- Connection thread : Metric (EN60423) / PG (DIN 40430)
- Protection class : IP67
- Certificates : -45 °C +105 °C
- Temperature range

Properties

- Easy to assemble
- Fixed or swivel body versions
- Apply with either LGT or CTS, CTPS Type conduits

**AĞIR HİZMET SİRAL BORU RAKORU
DİŞİ (BORU) TİP SABİT & DÖNER DİŞ**

- Hammaddesi : Pirinç, nikel kaplı
- Bağlantı dişi M : EN 60423
- Bağlantı dişi PG : DIN 40430
- Koruma sınıfı : IP67
- O-ring : Nitril kauçuk
- Uygun spiral : LGT-CTS-CTPS

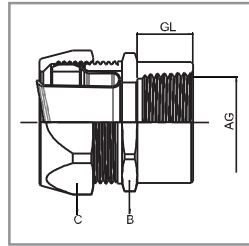
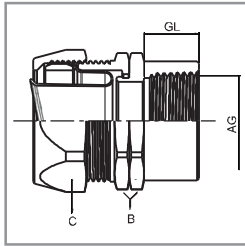

FIXED BODY

Code		AG Thread		Spiral	GL	B	C
PG	Metric	PG	Metric	Measure	mm.	mm.	mm.
LSRPD 00	LSRMD 00	PG 7	M 12 x 1,5	LGT10 - 1/4"	10	20	22
LSRPD 1A	LSRMD 1A	PG 9	M 16 x 1,5	LGT10 - 1/4"	10	20	22
LSRPD 01	LSRMD 01	PG 11	M 16 x 1,5	LGT13 - 3/8"	11,5	24	26
LSRPD 2A	-	PG 13,5	-	LGT16 - 1/2"	13	27	29
LSRPD 02	LSRMD 02	PG 16	M 20 x 1,5	LGT16 - 1/2"	13	27	29
LSRPD 03	LSRMD 03	PG 21	M 25 x 1,5	LGT21 - 3/4"	15	33	35
LSRPD 04	LSRMD 04	PG 29	M 32 x 1,5	LGT27 - 1"	15	43	45
LSRPD 05	LSRMD 05	PG 36	M 40 x 1,5	LGT35 - 1 1/4"	16	52	54
LSRPD 06	LSRMD 06	PG 42	M 50 x 1,5	LGT40 - 1 1/2"	18	60	63
LSRPD 07	LSRMD 07	PG 48	M 63 x 1,5	LGT51 - 2"	20	74	77
	LSRMD 08		M 72 x 1,5	LGT63 - 2 1/2"	20	90	90
	LSRMD 09		M 75 x 1,5	LGT78 - 3"	24	105	110
	LSRMD 10		M 100 x 2	LGT102 - 4"	30	136	140

SWIVEL BODY

LSRDPD 00	LSRDMD 00	PG 7	M 12 x 1,5	LGT10 - 1/4"	10	20	22
LSRDPD 1A	LSRDMD 1A	PG 9	M 16 x 1,5	LGT10 - 1/4"	10	20	22
LSRDPD 01	LSRDMD 01	PG 11	M 16 x 1,5	LGT13 - 3/8"	11,5	24	26
LSRDPD 2A	-	PG 13,5	-	LGT16 - 1/2"	13	27	29
LSRDPD 02	LSRDMD 02	PG 16	M 20 x 1,5	LGT16 - 1/2"	13	27	29
LSRDPD 03	LSRDMD 03	PG 21	M 25 x 1,5	LGT21 - 3/4"	15	33	35
LSRDPD 04	LSRDMD 04	PG 29	M 32 x 1,5	LGT27 - 1"	15	43	45
LSRDPD 05	LSRDMD 05	PG 36	M 40 x 1,5	LGT35 - 1 1/4"	16	52	54
LSRDPD 06	LSRDMD 06	PG 42	M 50 x 1,5	LGT40 - 1 1/2"	18	60	63
LSRDPD 07	LSRDMD 07	PG 48	M 63 x 1,5	LGT51 - 2"	20	74	77
	LSRDMD 08		M 72 x 1,5	LGT63 - 2 1/2"	20	90	90
	LSRDMD 09		M 75 x 1,5	LGT78 - 3"	24	105	110
	LSRDMD 10		M 100 x 2	LGT102 - 4"	30	136	140

PRODUCT RANGE OVERVIEW

TACFLEX FLEXIBLE CONDUIT FITTINGS



FLEXIBLE SPIRAL CONDUIT FITTINGS LIQUID TIGHT NPT FEMALE TYPE FIXED & SWIVEL

TECHNICAL DETAILS

Material

Cap nut	: Galvanised with nickel plated
Ring	: PA6
Ferrule	: Aluminium / Galvanised
Gland body	: Brass with nickel plated
O-ring	: NBR
Connection thread	: NPT ANSI B1.20.1
Protection class	: IP67
Temperature range	: -45 °C +105 °C
Certificates	

Properties

Easy to assemble
Fixed or swivel body versions
Apply with either LGT or CTS, CTPS type conduits

AĞIR HİZMET SİRAL BORU RAKORU DİŞİ (BORU) TİP SABİT & DÖNER DİŞİ

Hammaddesi	: Pirinç, nikel kaplı
Bağlantı dişi NPT	: NPT ANSI B1.20.1
Koruma sınıfı	: IP67
O-ring	: Nitril kauçuk
Uygun spiral	: LGT-CTS-CTPS

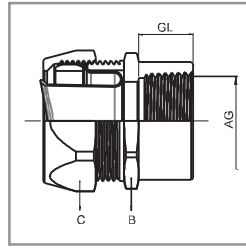
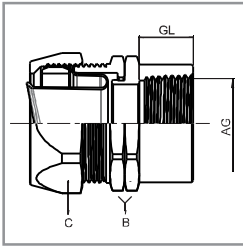

NPT / FIXED BODY

Code	NPT Thread	Spiral Measure	GL mm.	B mm.	C mm.
LSRND 00	1/4"	LGT10 - 1/4"	10	20	22
LSRND 01	3/8"	LGT13 - 3/8"	11,5	24	26
LSRND 02	1/2"	LGT16 - 1/2"	13	27	29
LSRND 03	3/4"	LGT21 - 3/4"	15	33	35
LSRND 04	1"	LGT27 - 1"	15	43	45
LSRND 05	1 1/4"	LGT35 - 1 1/4"	16	52	54
LSRND 06	1 1/2"	LGT40 - 1 1/2"	18	60	63
LSRND 07	2"	LGT51 - 2"	20	74	77
LSRND 08	2 1/2"	LGT63 - 2 1/2"	20	90	90
LSRND 09	3"	LGT78 - 3"	24	105	110
LSRND 10	4"	LGT102 - 4"	30	136	140

SWIVEL BODY

LSRDND 00	1/4"	LGT10 - 1/4"	10	20	22
LSRDND 01	3/8"	LGT13 - 3/8"	11,5	24	26
LSRDND 02	1/2"	LGT16 - 1/2"	13	27	29
LSRDND 03	3/4"	LGT21 - 3/4"	15	33	35
LSRDND 04	1"	LGT27 - 1"	15	43	45
LSRDND 05	1 1/4"	LGT35 - 1 1/4"	16	52	54
LSRDND 06	1 1/2"	LGT40 - 1 1/2"	18	60	63
LSRDND 07	2"	LGT51 - 2"	20	74	77
LSRDND 08	2 1/2"	LGT63 - 2 1/2"	20	90	90
LSRDND 09	3"	LGT78 - 3"	24	105	110
LSRDND 10	4"	LGT102 - 4"	30	136	140

PRODUCT RANGE OVERVIEW

IP67

TACFLEX FLEXIBLE CONDUIT FITTINGS



**STEEL WIRE OVER BRAIDING
PLASTIC CONDUIT FITTINGS
FIXED & SWIVEL**

TECHNICAL DETAILS

Material

- Cap nut : Brass with nickel plated
- Conduit holder : PA6
- Armour clamp : Brass
- Gland body : Brass with nickel plated
- O-ring : NBR
- Connection thread : Metric (EN60423) / PG (DIN 40430)
- Protection class : IP67
- Temperature range : -30 °C +100 °C
- Certificates

Properties

- Easy to assemble
- Fixed or swivel body versions
- Apply with either CTPAS type conduits

**ÇELİK TEL ÖRGÜLÜ POLYAMİD SİRAL RAKORLARI
SABİT & DÖNER TİP**

- Hammaddesi : Piring, nikel kaplı
- Bağlantı dişi M : EN 60423
- Bağlantı dişi PG : DIN 40430
- Koruma sınıfı : IP67
- O-ring : Nitril kauçuk
- Uygun spiral : CTPAS

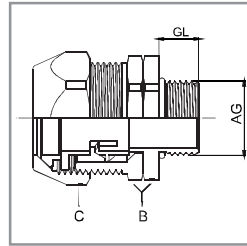
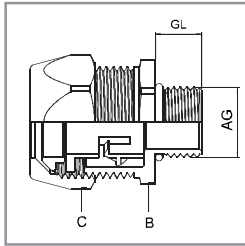

FIXED/SWIVEL BODY

Code	AG Thread		Spiral Measure	GL mm.	B mm.	C mm.	
	PG	Metric					PG
LSRPAG 13-PG9	LSRPAG 13-M16	PG 9	M 16 x 1,5	CTPAS-09	10	24	26
LSRPAG 15-PG11	LSRPAG 15-M16	PG 11	M 16 x 1,5	CTPAS-11	10	28	30
LSRPAG 18-PG13,5	LSRPAG 18-M20	PG13,5	M 20 x 1,5	CTPAS-13,5	10	32	35
LSRPAG 21-PG16	LSRPAG 21-M20	PG 16	M 20 x 1,5	CTPAS-16	10	35	35
LSRPAG 28-PG21	LSRPAG 28-M25	PG 21	M 25 x 1,5	CTPAS-21	14	45	45
LSRPAG 34-PG29	LSRPAG 34-M32	PG 29	M 32 x 1,5	CTPAS-29	15	50	50
LSRPAG 42-PG36	LSRPAG 42-M40	PG 36	M 40 x 1,5	CTPAS-36	15	60	60
LSRPAG 54-PG42	LSRPAG 54-M50	PG 42	M 50 x 1,5	CTPAS-48	15	70	75
LSRPAG 54-PG48	LSRPAG 54-M63	PG 48	M 63 x 1,5	CTPAS-48	15	70	75
SWIVEL BODY							
LSRDPAG 13-PG9	LSRDPAG 13-M16	PG 9	M 16 x 1,5	CTPAS-09	10	24	26
LSRDPAG 15-PG11	LSRDPAG 15-M16	PG 11	M 16 x 1,5	CTPAS-11	10	28	30
LSRDPAG 18-PG13,5	LSRDPAG 18-M20	PG13,5	M 20 x 1,5	CTPAS-13,5	10	32	35
LSRDPAG 21-PG16	LSRDPAG 21-M20	PG 16	M 20 x 1,5	CTPAS-16	10	35	35
LSRDPAG 28-PG21	LSRDPAG 28-M25	PG 21	M 25 x 1,5	CTPAS-21	14	45	45
LSRDPAG 34-PG29	LSRDPAG 34-M32	PG 29	M 32 x 1,5	CTPAS-29	15	50	50
LSRDPAG 42-PG36	LSRDPAG 42-M40	PG 36	M 40 x 1,5	CTPAS-36	15	60	60
LSRDPAG 54-PG42	LSRDPAG 54-M50	PG 42	M 50 x 1,5	CTPAS-48	15	70	75
LSRDPAG 54-PG48	LSRDPAG 54-M63	PG 48	M 63 x 1,5	CTPAS-48	15	70	75

PRODUCT RANGE OVERVIEW

TACFLEX FLEXIBLE CONDUIT FITTINGS



LIQUID TIGHT SPIRAL CONDUIT FITTINGS WITH CABLE HOLDER

TECHNICAL DETAILS

Material

Cap nut	: Brass with nickel plated
Clamping insert	: PA6
Sealing ring	: TPV
Ring	: Polyethylene
Ferrule	: Aluminium / Galvanised
Gland body	: Brass with nickel plated
O-ring	: NBR
Connection thread	: Metric (EN60423) / PG (DIN 40430)
Protection class	: IP67
Temperature range	: -30 °C +100 °C
Certificates	

Properties

Easy to assemble
Fixed or swivel body versions
Apply with either LGT or CTS, CTPS type conduits

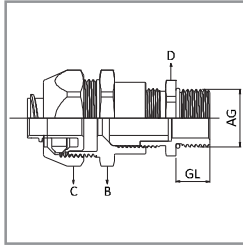

AĞIR HİZMET KABLO TUTUCULU SİRAL BORU RAKORU SABİT & DÖNER DİŞ

Hammaddesi	: Piring, nikel kaplı
Bağlantı dişi M	: EN 60423
Bağlantı dişi PG	: DIN 40430
Koruma sınıfı	: IP67
O-ring	: Nitril kauçuk
Uygun spiral	: LGT-CTS-CTPS

PG FIXED BODY

Code	AG Thread	Spiral Measure	GL mm.	B mm.	C mm.	D mm.	Cables mm.
MLSRP 00	PG 7	10 - 1/4"	6	20	22	14	3-6,5
MLSRP 1A	PG 9	10 - 1/4"	6	20	22	17	4-8
MLSRP 01	PG 11	13 - 3/8"	6	24	26	20	5-10
MLSRP 2A	PG 13,5	16 - 1/2"	6,5	27	29	22	6-12
MLSRP 02	PG 16	16 - 1/2"	6,5	27	29	24	10-14
MLSRP 03	PG 21	21 - 3/4"	7	33	35	30	13-18
MLSRP 04	PG 29	26 - 1"	8	43	45	40	18-25
MLSRP 05	PG 36	35 - 1 1/4"	10	52	54	50	22-32
MLSRP 06	PG 42	40 - 1 1/2"	12	60	63	57	30-38
MLSRP 07	PG 48	51 - 2"	14	74	77	64	33-44

METRIC FIXED BODY

Code	AG Thread	Spiral Measure	GL mm.	B mm.	C mm.	D mm.	Cables mm.
MLSRM 00	M 12 x 1,5	10 - 1/4"	6	20	22	14	3-6,5
MLSRM 1A	M 16 x 1,5	10 - 1/4"	7	20	22	18	4-8
MLSRM 01	M 16 x 1,5	13 - 3/8"	7	24	26	18	4-8
MLSRM 02	M 20 x 1,5	16 - 1/2"	8	27	29	22	6-12
MLSRM 03	M 25 x 1,5	21 - 3/4"	8	33	35	27	10-14
MLSRM 04	M 32 x 1,5	26 - 1"	9	43	45	34	13-18
MLSRM 05	M 40 x 1,5	35 - 1 1/4"	9	52	54	43	18-25
MLSRM 06	M 50 x 1,5	40 - 1 1/2"	9	60	63	55	22-32
MLSRM 07	M 63 x 1,5	51 - 2"	14	74	77	68	33-44
MLSRM 08	M 72 x 1,5	63 - 2 1/2"	20	90	90	85	45-55
MLSRM 09	M 75 x 1,5	78 - 3"	20	105	110	90	50-63
MLSRM 10	M 100 x 2	102 - 4"	30	136	140	100	60-70

* Swivel body versions are available too.

TACFLEX FLEXIBLE CONDUIT FITTINGS



LIQUID TIGHT SPIRAL CONDUITS FITTINGS NPT WITH CABLE HOLDER MALE/FEMALE

TECHNICAL DETAILS

Material

- Cap nut : Brass with nickel plated
- Clamping insert : PA6
- Sealing ring : TPV
- Ring : Polyethylene
- Ferrule : Aluminium / Galvanised
- Gland body : Brass with nickel plated
- O-ring : NBR
- Connection thread : NPT ANSI B1.20.1
- Protection class : IP67
- Temperature range : -30 °C +100 °C
- Certificates

Properties

- Easy to assemble
- Fixed or swivel body versions
- Apply with either LGT, LGTHF or CTS, CTPS type conduits

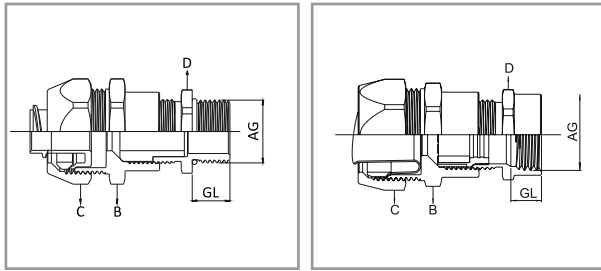

NPT / MALE TYPE

Code	NPT Thread	Spiral Measure	GL mm.	B mm.	C mm.	D mm.	Cables mm.
MLSRN 00	1/4"	10 - 1/4"	15	20	22	14	3-6,5
MLSRN 1A	3/8"	10 - 1/4"	15	20	22	18	4-8
MLSRN 01	3/8"	13 - 3/8"	15	24	26	20	5-10
MLSRN 2A	1/2"	16 - 1/2"	15	27	29	22	6-12
MLSRN 02	1/2"	16 - 1/2"	15	27	29	24	10-14
MLSRN 03	3/4"	21 - 3/4"	15	33	35	30	13-18
MLSRN 04	1"	26 - 1"	15	43	45	40	18-25
MLSRN 05	1 1/4"	35 - 1 1/4"	18	52	54	50	22-32
MLSRN 06	1 1/2"	40 - 1 1/2"	18	60	63	55	30-38
MLSRN 07	2"	51 - 2"	20	74	77	65	33-44
MLSRN 08	2 1/2"	63 - 2 1/2"	20	90	90	75	45-55
MLSRN 09	3"	78 - 3"	24	105	110	90	50-63
MLSRN 10	4"	102 - 4"	30	136	140	100	60-70

NPT / FEMALE TYPE

MLSRND 00	1/4"	10 - 1/4"	15	20	22	14	3-6,5
MLSRND 1A	3/8"	10 - 1/4"	15	20	22	18	4-8
MLSRND 01	3/8"	13 - 3/8"	15	24	26	20	5-10
MLSRND 2A	1/2"	16 - 1/2"	15	27	29	22	6-12
MLSRND 02	1/2"	16 - 1/2"	15	27	29	24	10-14
MLSRND 03	3/4"	21 - 3/4"	15	33	35	30	13-18
MLSRND 04	1"	26 - 1"	15	43	45	40	18-25
MLSRND 05	1 1/4"	35 - 1 1/4"	18	52	54	50	22-32
MLSRND 06	1 1/2"	40 - 1 1/2"	18	60	63	55	30-38
MLSRND 07	2"	51 - 2"	20	74	77	65	33-44
MLSRND 08	2 1/2"	63 - 2 1/2"	20	90	90	75	45-55
MLSRND 09	3"	78 - 3"	24	105	110	90	50-63
MLSRND 10	4"	102 - 4"	30	136	140	100	60-70

* Special size versions are available.

PRODUCT RANGE OVERVIEW

IP67

TACFLEX FLEXIBLE CONDUIT FITTINGS



FLEXIBLE SPIRAL CONDUIT FITTINGS FIXED BODY

TECHNICAL DETAILS

Material

Ring	: Brass with nickel plated
Fixed gland body	: Brass with nickel plated
O-ring	: NBR
Connection thread	: Metric (EN60423) / PG (DIN 40430)
Protection class	: IP54
Temperature range	: -30 °C +100 °C
Certificates	

Properties

Easy to assemble
Fixed or swivel body versions
Apply with either OCGS or OPCGS type conduits

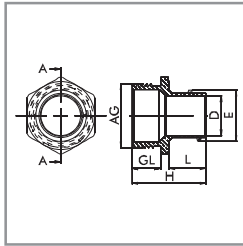

SABİT DİŞ SİRİAL BORU RAKORU

Hammaddesi	: Pirinç, nikel kaplı
Bağlantı dişi M	: EN 60423
Bağlantı dişi PG	: DIN 40430
Koruma sınıfı	: IP54
O-ring	: Nitril kauçuk
Uygun spiral	: OCGS-OPCGS

METRIC/PG THREAD FIXED BODY

AG Thread	Code	H mm.	GL mm.	L mm.	D mm.	mm.	E mm.
M 12 x 1,5	MMR 12	24	8	13	6	15	7,5 x 11,5
M 16 x 1,5	MMR 16	24	8	13	7	20	9 x 13
M 16 x 1,5	MMR 116	26	10	13	9	20	11 x 15
M 20 x 1,5	MMR 20	26	10	13	12	22	14 x 18
M 20 x 1,5	MMR 120	26	10	13	14	22	16 x 20
M 25 x 1,5	MMR 25	27	10	13	18	28	21 x 25
M 32 x 1,5	MMR 32	31	12	15	23	35	26 x 31
M 40 x 1,5	MMR 40	36	14	17	33,5	45	35 x 40
M 50 x 1,5	MMR 50	36	14	17	37	55	40 x 45
M 63 x 1,5	MMR 63	36	14	17	46	65	51 x 56
PG 7	MPR 7	24	8	13	6	15	7,5 x 11,5
PG 9	MPR 9	24	8	13	7	17	9 x 13
PG 11	MPR 11	26	10	13	9	20	11 x 15
PG 13,5	MPR 13,5	26	10	13	12	22	14 x 18
PG 16	MPR 16	26	10	13	14	24	16 x 20
PG 21	MPR 21	27	10	13	18	30	21 x 25
PG 29	MPR 29	31	12	15	23	40	26 x 31
PG 36	MPR 36	36	14	17	33,5	50	35 x 40
PG 42	MPR 42	36	14	17	37	60	40 x 45
PG 48	MPR 48	36	14	17	46	65	51 x 56

PRODUCT RANGE OVERVIEW

#541

TACFLEX FLEXIBLE CONDUIT FITTINGS



FLEXIBLE SPIRAL CONDUIT FITTINGS SWIVEL BODY

TECHNICAL DETAILS

Material

Ring	: Brass with nickel plated
Swivel gland body	: Brass with nickel plated
O-ring	: NBR
Connection thread	: Metric (EN60423) / PG (DIN 40430)
Protection class	: IP54
Temperature range	: -30 °C +100 °C
Certificates	

Properties

Easy to assemble
Fixed or swivel body versions
Apply with either OCGS or OPCGS type conduits

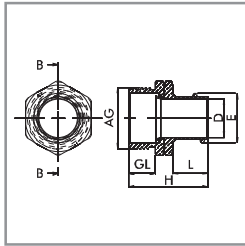

DÖNER DİŞ SPIRAL BORU RAKORU

Hammaddesi	: Pirinç, nikel kaplı
Bağlantı dişi M	: EN 60423
Bağlantı dişi PG	: DIN 40430
Koruma sınıfı	: IP54
O-ring	: Nitril kauçuk
Uygun spiral	: OCGS-OPCGS

METRIC/PG THREAD SWIVEL BODY

AG Thread	Code	H mm.	GL mm.	L mm.	D mm.	mm.	E mm.
M 12 x 1,5	MDM 12	27	8	13	6	15	7,5 x 11,5
M 16 x 1,5	MDM 16	27	8	13	7	20	9 x 13
M 16 x 1,5	MDM 116	29	10	13	9	20	11 x 15
M 20 x 1,5	MDM 20	29	10	13	12	22	14 x 18
M 20 x 1,5	MDM 120	29	10	13	14	22	16 x 20
M 25 x 1,5	MDM 25	31	10	13	18	28	21 x 25
M 32 x 1,5	MDM 32	35	12	15	23	35	26 x 31
M 40 x 1,5	MDM 40	41	14	17	33,5	45	35 x 40
M 50 x 1,5	MDM 50	41	14	17	37	55	40 x 45
M 63 x 1,5	MDM 63	41	14	17	46	65	51 x 56
PG 7	MDP 7	27	8	13	6	15	7,5 x 11,5
PG 9	MDP 9	27	8	13	7	17	9 x 13
PG 11	MDP 11	29	10	13	9	20	11 x 15
PG 13,5	MDP 13,5	29	10	13	12	22	14 x 18
PG 16	MDP 16	29	10	13	14	24	16 x 20
PG 21	MDP 21	31	10	13	18	30	21 x 25
PG 29	MDP 29	35	12	15	23	40	26 x 31
PG 36	MDP 36	41	14	17	33,5	50	35 x 40
PG 42	MDP 42	41	14	17	37	60	40 x 45
PG 48	MDP 48	41	14	17	46	65	51 x 56

PRODUCT RANGE OVERVIEW

TACFLEX FLEXIBLE CONDUIT FITTINGS



FLEXIBLE SPIRAL CONDUIT FITTINGS NPT FIXED BODY

TECHNICAL DETAILS

Material

Ring	: Brass with nickel plated
Swivel gland body	: Brass with nickel plated
O-ring	: NBR
Connection thread	: NPT ANSI B1.20.1
Protection class	: IP54
Temperature range	: -30 °C +100 °C
Certificates	

Properties

Easy to assemble
Fixed or swivel body versions
Apply with either OCGS or OPCGS type conduits

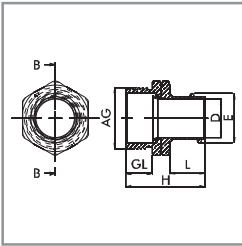

SABİT DİŞ SİRAL BORU RAKORU

Hammaddesi	: Pirinç, nikel kaplı
Bağlantı dişi NPT	: NPT ANSI B1.20.1
Koruma sınıfı	: IP54
O-ring	: Nitril kauçuk
Uygun spiral	: OCGS-OPCGS

NPT / FIXED

NPT Thread	Code	H mm.	GL mm.	L mm.	D mm.	mm.	E mm.
1/4"	MNR14	26	10	13	6	15	7,5 x 11,5
3/8"	MNR 38	27,5	11,5	13	7	18	9 x 13
3/8"	MNR 138	27,5	11,5	13	9	18	11 x 15
3/8"	MNR238	27,5	11,5	13	11	19	13 x 16,5
1/2"	MNR 12	29	13	13	12	22	14 x 18
1/2"	MNR 122	29	13	13	14	22	16 x 20
3/4"	MNR 34	32	15	13	18	28	21 x 25
1"	MNR 100	34	15	15	23	35	26 x 31
1 1/4"	MNR 114	38	16	17	33,5	45	35 x 40
1 1/2"	MNR 112	40	18	17	37	50	40 x 45
2"	MNR 200	42	20	17	46	65	51 x 56

* Swivel body versions are also available.

PRODUCT RANGE OVERVIEW

#541

DPJ

DPJ End type connector

- Material: Body: Nickle Plated Brass
Cover Lock Nut: Nickle Plated Brass ; Guarding: TPE;
Seal: modified rubber; Ferrule: galvanized steel
- Temperature Range: Min-40 C , Max105 C
- Protection Degree: IP66
- DPJ connector is suitable for JS, JSH and JSB conduits, while JSG conduits should use DPJW.
When place the order, please inform the dimension fo the conduit and the thread such as DPJ-15-G1/2", one end ϕ 15 conduit and the other end G1/2" outer thread.

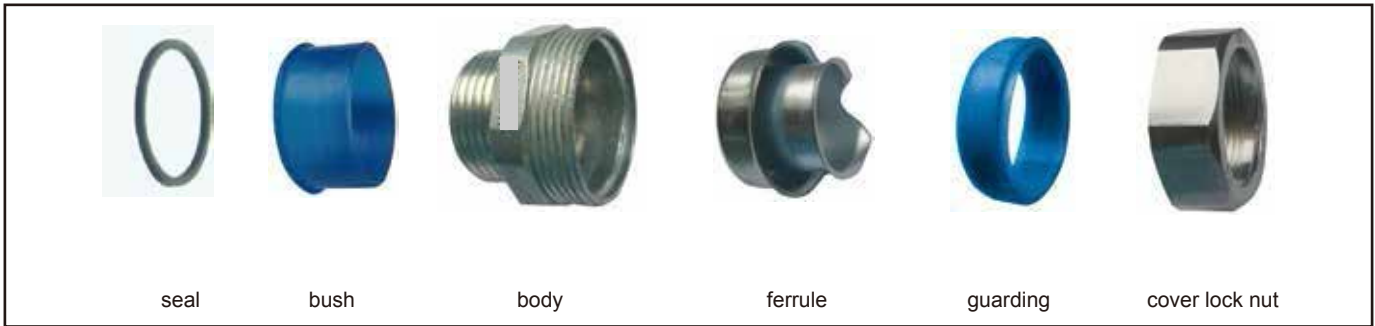

DPJ

The recommended dimension of the connector

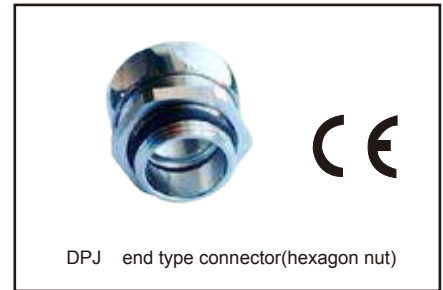

for conduit size		English thread	GL	Metric thread	GL	PG	Wrench size	packet units
Metric	English							
Ø6		G1/4"	7	M12 / M14	7	PG7	18/16	100
Ø8	1/4"	G3/8"	7	M14 / M16	8	PG9	24/22	50
Ø10	5/16"	G3/8"	7	M16	8	PG9	24/22	50
Ø12	3/8"	G3/8"	10	M18 / M20	10	PG11/ PG13.5	26	50
Ø15	1/2"	G1/2"	12	M20 / M22 / M24	10	PG13.5 / PG16	30	50
Ø21	3/4"	G3/4"	12	M25 / M27 / M30	12	PG21	35	25
Ø25	1"	G1"	14	M32 / M33 / M36	12	PG29	43	20
Ø32	1 1/4"	G1 1/4"	14	M36 / M40 / M42 / M48	14	PG29	52	10
Ø38	1 1/2"	G1 1/2"	16	M48 / M50	14	PG36 / PG42	60	10
Ø51	2"	G2"	16	M60 / M63 / M64 / M72	15	PG48	75	5
Ø64	2 1/2"	G2 1/2"		M76	20		89/87	2
Ø75	3"	G3"		M88	22		102/97	2
Ø100	4"	G4"		M114	28		133/128	2
Ø125	5"	G5"		M140	29		158	2
Ø150	6"	G6"		M164	29		183	2