

SUPAFLEX

heavy duty connectors industrial rectangular plug

www.supaflex.co.in



SUPAFLEX

ABOUT US

Supa Flex is one of the fastest growing companies in India, a privately owned company has unrivalled experience in the distribution of electrical products. With superior Technical support we are the experts you can rely on for your Cable protection needs. Our Customers are central to everything we do and our mission is to constantly exceed their expectations. Our ongoing commitment and dedication has seen us become globally recognised as a specialist in Cable Protection and Flexible Conduit Solutions.

PRODUCT CATALOG

ASSEMBLY DETAILS	01
SELECTION GUIDE	02-03
TERMINAL TYPE OVERVIEW	04
HA & HE SERIES	05-11
.....	12
HEE SERIES	13
HD SERIES	14
HDD SERIES	15
HEAV, HSB, HWK SERIES	16
HK, HQ SERIES	17
HM SERIES	18-22
CRIMP TERMINALS	23
ACCESSORY	24
3A METAL HOODS & HOUSING	25
10A METAL HOODS & HOUSING	26
16A METAL HOODS & HOUSING	27
32A METAL HOODS & HOUSING	28
6B HOODS & HOUSING	29-30
10B HOODS & HOUSING	31-33
16B HOODS & HOUSING	34-36
24B HOODS & HOUSING	37-39
32B HOODS & HOUSING	40-41
48B HOODS & HOUSING	42
CABLE GLANDS	43
CABLE GLANDS	44
CABLE GLANDS	45

www.supaflex.co.in



For a complete connector components may be order from the following sub headings

Male insert

Male insert with screw terminal, crimp terminal (order contacts separately) or cage-clamp terminal.

Female insert

Female insert with screw terminal, crimp terminal (order contacts separately) or cage-clamp terminal.

Hoods

Hoods with low or high construction, side or top cable entry, 2 or 4 bolts, 1 or 2 locking levers.

Housings

Bulkhead mounting housings with or without protection cover, 1 or 2 locking levers.

Surface mounting housings with low or high construction, with or without protection cover, 2 or 4 bolts, 1 or 2 locking levers, 1 or 2 cable entries.

Cable entry protection

Cable glands with normal or multiple sealing.

Metal or plastic cable glands.

Special cable entry protection or extensive range of accessories.

Accessories.

Protection cover available, code and guide pins for coding. Inserts fixing screws for use without hoods and housings.

Assembly details.

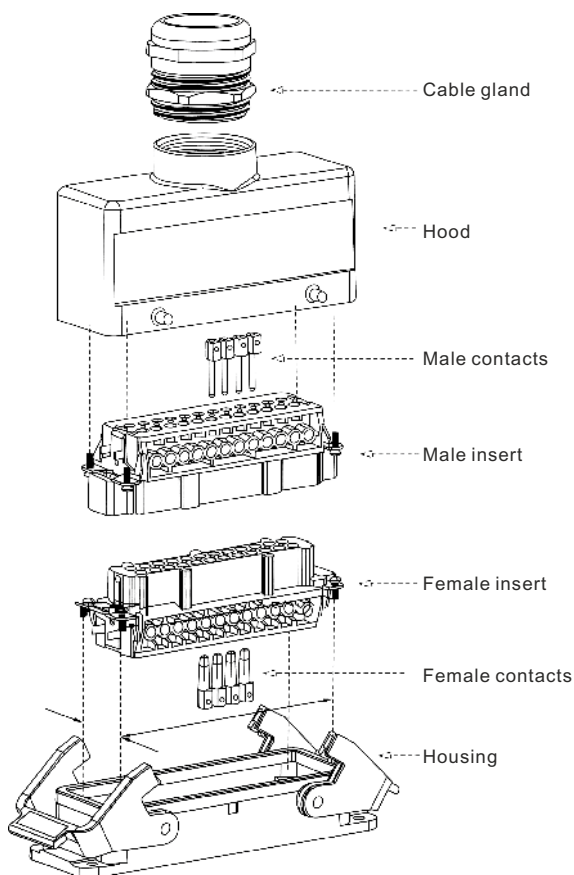

List of hoods and housings

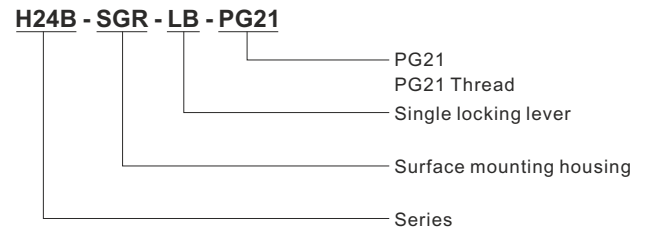

- AG → Bulkhead mounting housing
- AG-LB → Bulkhead mounting housing with single locking lever
- AD-BO → Bulkhead mounting housing with cover, bolts
- AD-LB → Bulkhead mounting housing with cover, single locking lever
- SGR → Surface mounting housing
- SDR H → Surface mounting housing with cover
- TS → Side entry hood
- TS H → High construction side entry hood
- TG → Top entry hood
- TG H → High construction top entry hood
- TSB → Side entry, double locking lever hood
- TGB → Top entry, double locking lever hood
- TBF → Cable coupler hood

When selecting heavy duty connector , we need to choose as follow

- ◆Rated voltage and current
- ◆Poles of connector
- ◆Choosing hood and housing type
- ◆Accessories(selecting cable gland)

Type explanation

HE-010-M

I.e.: HE-010-M means male insert of 10 poles in HE series.

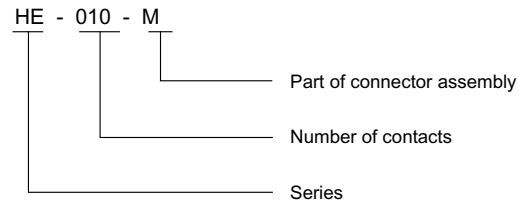

Set general overview

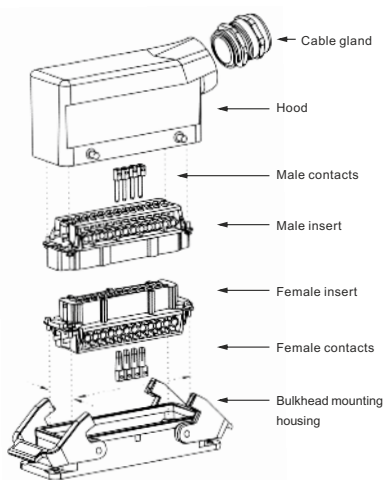

① Bulkhead mounting and side entry type.

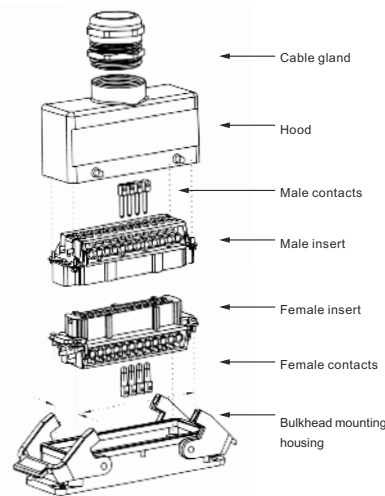

② Bulkhead mounting and top entry type.

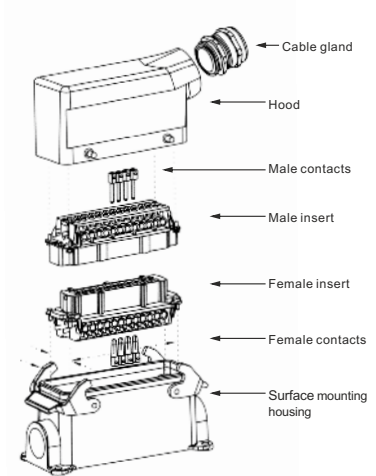

③ Surface mounting and side entry type.

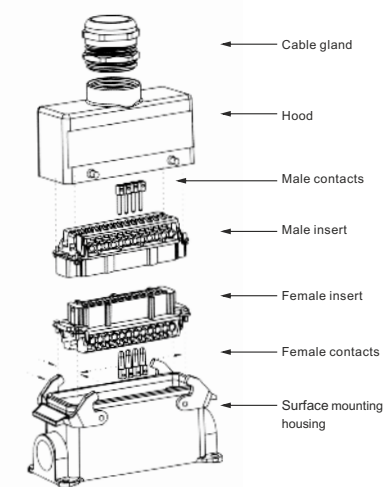

④ Surface mounting and top entry type.

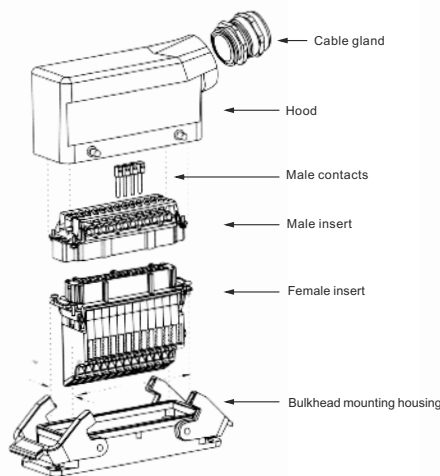

⑤ Through-panel connector and side entry type.

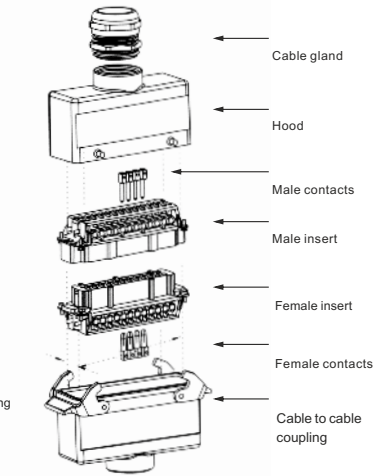

⑥ Cable to cable and top entry type.

All sets shown above with one lever types.

Overview : Rating VS . No . of poles								
Rated voltage	250V	250V	400V	500V	500V	690V	690V	
Rated current	10A	16A	16A	16A	35A	80A	100A	
Poles	3	HA-003				HK4/0-012		
	4	HA-004						
	5			HQ-005				
	6			HE-006		HSB-006	HK4/2-012	
	7	HD-007		HQ-007				
	8	HD-008						
	10		HA-010	HE-010	HEE-010			
	12					HSB-012	HK4/8-012	HK6/6-012
	15	HD-015						
	16		HA-016	HE-016				
	18				HEE-018			
	24	HDD-024		HE-024				
	25	HD-025						
	32		HA-032	HE-032	HEE-032			
	40	HD-040						
	42	HDD-042						
	46				HEE-046			
	48			HE-048				
	50	HD-050						
	64	HD-064			HEE-064			
	72	HDD-072						
	80	HD-080						
	92				HEE-092			
	108	HDD-108						
	128	HD-128						
	144	HDD-144						
216	HDD-216							

Overview : Rating VS . No . of poles						
hood	insert					
HA3	HA-003/HA-004		HD-007/HD-008	HQ-005/HD-007		
HA3	HA-003/HA-004		HD-007/HD-008	HQ-005/HD-005		
HA10, EMC	HA-10		HD-015			
HA16, EMC	HA-16		HD-025			
HA32, EMC	HA-032(16X2)		HD-050(25X2)			
HB6, EMC	HE-006	HE-010		HDD-024	HSB-006	HK4/0, HK4/2
HB10, EMC	HE-010	HE-018		HDD-42		HK4/8, HK6/6
HB16, EMC	HE-016	HE-032	HD-040	HDD-072		
HB24, EMC	HE-024	HE-046	HD-064	HDD-108		
HB32, EMC	HE-032(16X2)	HE-064(32X2)	HD-080(40X2)	HDD-144(72X2)	HSB-012(6X2)	
HB48, EMC	HE-048(24X2)	HE-092(46X2)	HD-128(64X2)	HDD-216(108X2)		

Screw terminal

- HA series
- HE series
- HSB series
- HK series
- HEAV series

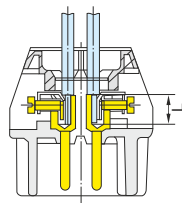

Inserts	max.wire gauge		Stripping length L (mm ²)
	(mm ²)	AWG	
HA-003, HA-004	2.5	14	4.5
HE, HA, HEAV	2.5	14	7.5
HE	4.0	12	7.5
HSB	6.0	10	11.5
HK	16.0	5	14.0

Crimp terminal

- HD series
- HDD series
- HM series (10A)

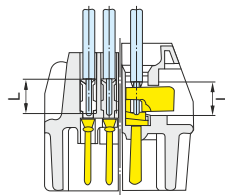

Inserts	Wire gauge		Stripping length L (mm ²)	
	(mm ²)	AWG	HDD/HD	HEC/HAC
HD HDD HM(10A)	0.5	20	8.0	7.5
	0.75	18	8.0	7.5
	1.0	18	8.0	7.5
	1.5	16	8.0	7.5
	2.5	14	8.0	7.5
	4.0	12	—	7.5

- HEE series
- HM series (16A)

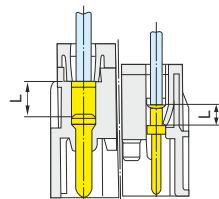

Inserts	Wire gauge		Stripping length L (mm ²)
	(mm ²)	AWG	HEE/HM(16A)
HEE HM(16A)	0.5	20	7.5
	0.75	18	7.5
	1.0	18	7.5
	1.5	16	7.5
	2.5	14	7.5
	4.0	12	7.5

Cage-clamp terminal

- HES series
- HEAVS series

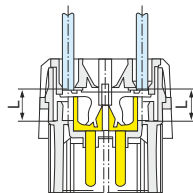

Inserts	max.wire gauge		Stripping length
	(mm ²)	AWG	L (mm ²)
HES, HEAVS	0.14-2.5	26-14	9...11

Product Feature

Terminals With Wire Protection

There is a spring inside the terminal, to enlarge the contact area and tighten the wire, which avoids the bare wires twisted and broken caused by the screw.

For the use of them, see figures

Threaded Terminal

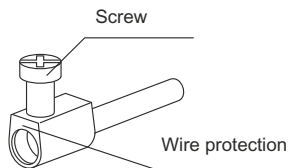

Set general introduction

HA Series 3 Poles of connector



HA-003-M

HA-003-F

A

B

A, B, C, D



C

H3A-MTS

H3A-MTG

H3A-MTS

H3A-MTG

H3A-MTG

D

H3A-MAG

H3A-MAG

H3A-MAGSV

H3A-MAGSV

H3A-MTGVB

HDC-HA-003-1
side entry

HDC-HA-003-2
Top entry

HDC-HA-003-3
Surface mounted

HDC-HA-003-4
Surface mounted

HDC-HA-003-5
Cable to cable

Technical data

Rated current: 10A
 Rated voltage: 230/250V
 Flammability acc.to UL94: V0
 Degree of protection acc.to DIN40 050: IP65
 Terminal: Screw terminal
 Thread: M20, PG11

Order NO.

HA Series 4 Poles of connector



HA-004-M

HA-004-F

A

B

HA-004-M

HA-004-F

A, B, C, D



C

H3A-MTS

H3A-MTG

H3A-MTS

H3A-MTG

H3A-MTG

D

H3A-MAG

H3A-MAG

H3A-MAGSV

H3A-MAGSV

H3A-MTGVB

HDC-HA-004-1
side entry

HDC-HA-004-2
Top entry

HDC-HA-004-3
Surface mounted

HDC-HA-004-4
Surface mounted

HDC-HA-004-5
Cable to cable

Technical data

Rated current: 10A
 Rated voltage: 230/250V
 Flammability acc.to UL94: V0
 Degree of protection acc.to DIN40 050: IP65
 Terminal: Screw terminal
 Thread: M20, PG11

Order NO.

HA Series 10 Poles of connector

Technical data

Rated current: 16A
 Rated voltage: 230/250V
 Flammability acc.to UL94: V0
 Degree of protection acc.to DIN40 050: IP65
 Terminal: Screw terminal
 Thread: M20, PG11

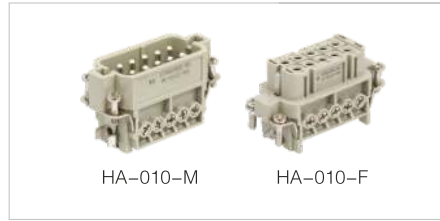

HA-010-M

HA-010-F

A

B

A, B, C, D



C

D

H10A-TS-2B

H10A-TG-2B

H10A-TS-2B

H10A-TG-2B

H10A-TS-2B

H10A-TG-2B

H10A-AG-LB

H10A-AG-LB

H10A-SGR-LB

H10A-SGR-LB

H10A-AD-LB

H10A-AD-LB

Order NO.

HDC-HA-010-1 side entry	HDC-HA-010-2 Top entry	HDC-HA-010-3 Surface mounted	HDC-HA-010-4 Surface mounted	HDC-HA-010-1DB BulkHAad mounted	HDC-HA-010-2DB BulkHAad mounted
----------------------------	---------------------------	---------------------------------	---------------------------------	------------------------------------	------------------------------------

HA Series 16 Poles of connector (With 1 levers)

Technical data

Rated current: 16A
 Rated voltage: 230/250V
 Flammability acc.to UL94: V0
 Degree of protection acc.to DIN40 050: IP65
 Terminal: Screw terminal
 Thread: M20, PG11

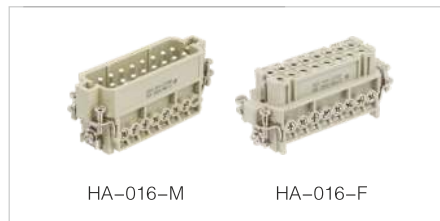

HA-016-M

HA-016-F

A

B

A, B, C, D



C

D

H16A-TS-2B

H16A-TG-2B

H16A-TS-2B

H16A-TG-2B

H16A-TS-2B

H16A-TG-2B

H16A-AG-LB

H16A-AG-LB

H16A-SGR-LB

H16A-SGR-LB

H16A-AD-LB

H16A-AD-LB

Order NO.

HDC-HA-016-1 Dide entry	HDC-HA-016-2 Top entry	HDC-HA-016-3 Durface mounted	HDC-HA-016-4 Durface mounted	HDC-HA-016-1DB BulkHAad mounted	HDC-HA-016-2DB BulkHAad mounted
----------------------------	---------------------------	---------------------------------	---------------------------------	------------------------------------	------------------------------------

Set general introduction

HA Series 32 Poles of connector (With 2 levers)

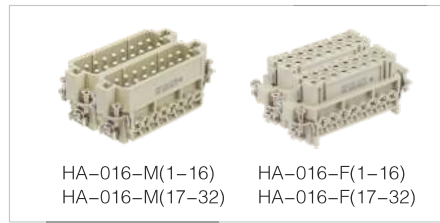

HA-016-M(1-16)
HA-016-M(17-32) HA-016-F(1-16)
HA-016-F(17-32)

A **B**

A, B, C, D



HDC-HA-032-1 side entry	HDC-HA-032-2 Top entry	HDC-HA-032-3 Surface mounted	HDC-HA-032-4 Surface mounted	HDC-HA-032-1BS BulkHAad mounted	HDC-HA-032-2BS BulkHAad mounted
----------------------------	---------------------------	---------------------------------	---------------------------------	------------------------------------	------------------------------------

Technical data

Rated current: 16A
 Rated voltage: 230/250V
 Flammability acc.to UL94: V0
 Degree of protection acc.to DIN40 050: IP65
 Terminal: Screw terminal
 Thread: M20, PG11

Order NO.

HE Series 6 Poles of connector



HE-006-M HE-006-F

A **B**

A, B, C, D



HDC-HE-006-1D side entry	HDC-HE-006-2D Top entry	HDC-HE-006-3D Surface mounted	HDC-HE-006-4D Surface mounted	HDC-HE-006-1DB Bulkhead mounted	HDC-HE-006-2DB Bulkhead mounted
-----------------------------	----------------------------	----------------------------------	----------------------------------	------------------------------------	------------------------------------

Technical data

Rated current: 16A
 Rated voltage: 400/500V
 Flammability acc.to UL94: V0
 Degree of protection acc.to DIN40 050: IP65
 Terminal: Screw terminal
 Spring terminal
 Crimp terminal
 Thread: M20, M25, PG16, PG21

Order NO.

HE Series 10 Poles of connector (With 2 levers)

Technical data

Rated current: 16A
 Rated voltage: 400/500V
 Flammability acc.to UL94: V0
 Degree of protection acc.to
 DIN40 050: IP65
 Terminal: Screw terminal
 Spring terminal
 Crimp terminal
 Thread: M20, M25, PG16, PG21

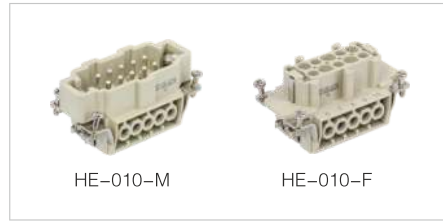

HE-010-M HE-010-F

A B

A, B, C, D



Order NO.

HDC-HE-010-1 side entry	HDC-HE-010-2 Top entry	HDC-HE-010-3 Surface mounted	HDC-HE-010-4 Surface mounted	HDC-HE-010-1BS Bulkhead mounted	HDC-HE-010-2BS Bulkhead mounted
----------------------------	---------------------------	---------------------------------	---------------------------------	------------------------------------	------------------------------------

HE Series 10 Poles of connector (With 1 lever)

Technical data

Rated current: 16A
 Rated voltage: 400/500V
 Flammability acc.to UL94: V0
 Degree of protection acc.to
 DIN40 050: IP65
 Terminal: Screw terminal
 Spring terminal
 Crimp terminal
 Thread: M20, M25, PG16, PG21



HE-010-M HE-010-F

A B

A, B, C, D



Order NO.

HDC-HE-010-1D side entry	HDC-HE-010-2D Top entry	HDC-HE-010-3D Surface mounted	HDC-HE-010-4D Surface mounted	HDC-HE-010-1DB Bulkhead mounted	HDC-HE-010-2DB Bulkhead mounted
-----------------------------	----------------------------	----------------------------------	----------------------------------	------------------------------------	------------------------------------

Set general introduction

HE Series 16 Poles of connector (With 2 levers)



HE-016-M

HE-016-F

A

B

A, B, C, D



HDC-HE-016-1 side entry	HDC-HE-016-2 Top entry	HDC-HE-016-3 Surface mounted	HDC-HE-016-4 Surface mounted	HDC-HE-016-1BS Bulkhead mounted	HDC-HE-016-2BS Bulkhead mounted
----------------------------	---------------------------	---------------------------------	---------------------------------	------------------------------------	------------------------------------

Technical data

Rated current: 16A
 Rated voltage: 400/500V
 Flammability acc.to UL94: V0
 Degree of protection acc.to DIN40 050: IP65
 Terminal: Screw terminal
 Spring terminal
 Crimp terminal
 Thread: M20, M25, PG16, PG21

Order NO.

HE Series 16 Poles of connector (With 1 levers)

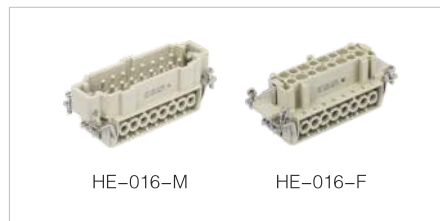

HE-016-M

HE-016-F

A

B

A, B, C, D



HDC-HE-016-1D side entry	HDC-HE-016-2D Top entry	HDC-HE-016-3D Surface mounted	HDC-HE-016-4D Surface mounted	HDC-HE-016-1DB Bulkhead mounted	HDC-HE-016-2DB Bulkhead mounted
-----------------------------	----------------------------	----------------------------------	----------------------------------	------------------------------------	------------------------------------

Technical data

Rated current: 16A
 Rated voltage: 400/500V
 Flammability acc.to UL94: V0
 Degree of protection acc.to DIN40 050: IP65
 Terminal: Screw terminal
 Spring terminal
 Crimp terminal
 Thread: M20, M25, PG16, PG21

Order NO.

HE Series 24 Poles of connector (With 2 levers)

Technical data

Rated current: 16A
 Rated voltage: 400/500V
 Flammability acc.to UL94: V0
 Degree of protection acc.to DIN40 050: IP65
 Terminal: Screw terminal
 Spring terminal
 Crimp terminal
 Thread: M20, M25, PG16, PG21



HE-024-M

HE-024-F

A

B

A, B, C, D



C

D

H24B-TS

H24B-TG

H24B-TS

H24B-TG

H24B-TSB

H24B-TGB

H24B-AG

H24B-AG

H24B-SGR

H24B-SGR

H24B-AD-BO

H24B-AD-BO

Order NO.

HDC-HE-024-1
side entry

HDC-HE-024-2
Top entry

HDC-HE-024-3
Surface mounted

HDC-HE-024-4
Surface mounted

HDC-HE-024-1BS
Bulkhead mounted

HDC-HE-024-2BS
Bulkhead mounted

HE Series 24 Poles of connector (With 1 lever)

Technical data

Rated current: 16A
 Rated voltage: 400/500V
 Flammability acc.to UL94: V0
 Degree of protection acc.to DIN40 050: IP65
 Terminal: Screw terminal
 Spring terminal
 Crimp terminal
 Thread: M20, M25, PG16, PG21



HE-024-M

HE-024-F

A

B

A, B, C, D

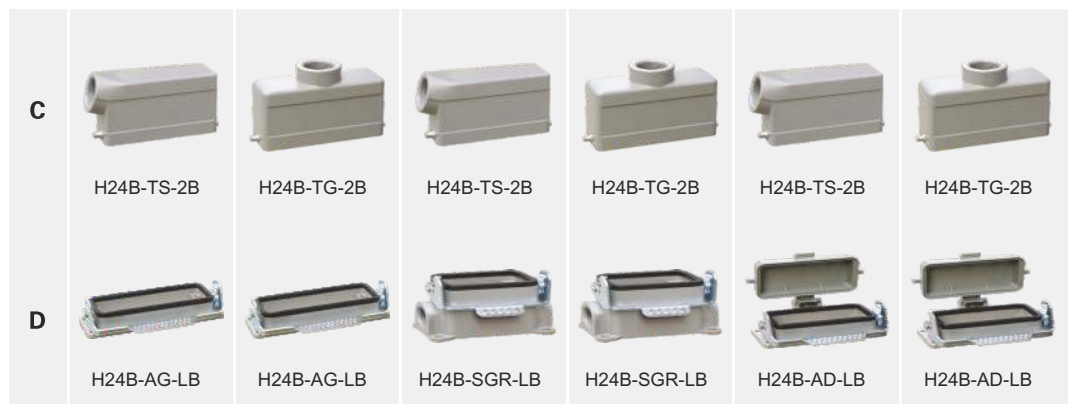

C

D

H24B-TS-2B

H24B-TG-2B

H24B-TS-2B

H24B-TG-2B

H24B-TS-2B

H24B-TG-2B

H24B-AG-LB

H24B-AG-LB

H24B-SGR-LB

H24B-SGR-LB

H24B-AD-LB

H24B-AD-LB

Order NO.

HDC-HE-024-1D
side entry

HDC-HE-024-2D
Top entry

HDC-HE-024-3D
Surface mounted

HDC-HE-024-4D
Surface mounted

HDC-HE-024-1DB
Bulkhead mounted

HDC-HE-024-2DB
Bulkhead mounted

Set general introduction

HE Series 32 Poles of connector (With 1, 2 levers)

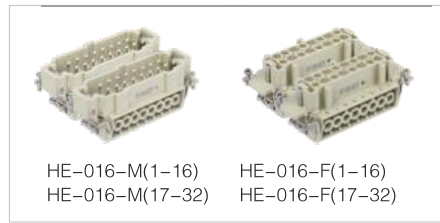

HE-016-M(1-16) HE-016-F(1-16)
HE-016-M(17-32) HE-016-F(17-32)

A **B**

A, B, C, D



HDC-HE-032-1 side entry	HDC-HE-032-2 Top entry	HDC-HE-032-3 Surface mounted	HDC-HE-032-4 Surface mounted	HDC-HE-032-1D Bulkhead mounted	HDC-HE-032-2D Bulkhead mounted
----------------------------	---------------------------	---------------------------------	---------------------------------	-----------------------------------	-----------------------------------

Technical data

Rated current: 16A
Rated voltage: 400/500V
Flammability acc.to UL94: V0
Degree of protection acc.to DIN40 050: IP65
Terminal: Screw terminal
Spring terminal
Crimp terminal
Thread: M25, M32, PG21, PG29

Order NO.

HE Series 48 Poles of connector

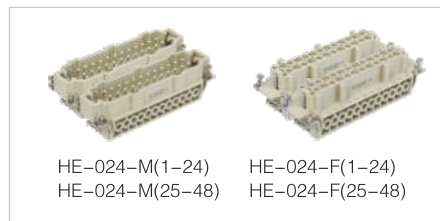

HE-024-M(1-24) HE-024-F(1-24)
HE-024-M(25-48) HE-024-F(25-48)

A **B**

A, B, C, D

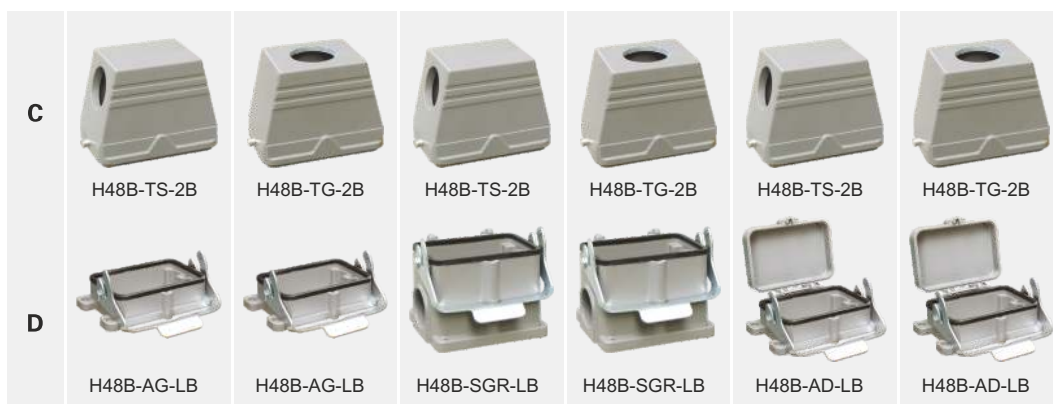







HDC-HE-048-1D side entry	HDC-HE-048-2D Top entry	HDC-HE-048-3D Surface mounted	HDC-HE-048-4D Surface mounted	HDC-HE-048-1DB Bulkhead mounted	HDC-HE-048-2DB Bulkhead mounted
-----------------------------	----------------------------	----------------------------------	----------------------------------	------------------------------------	------------------------------------



Technical data





Rated current: 16A
Rated voltage: 400/500V
Flammability acc.to UL94: V0
Degree of protection acc.to DIN40 050: IP65
Terminal: Screw terminal
Spring terminal
Crimp terminal
Thread: M32, PG29, PG36

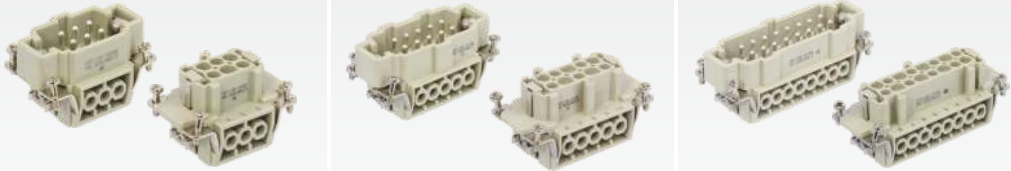

Order NO.



HA Series	3+ 	4+ 
Technical data <ul style="list-style-type: none"> ◆ Rated current: 10A ◆ Rated voltage: 230/250V ◆ Terminal: Screw terminal 		
(M/F)	HA-003-M HA-003-F	HA-004-M HA-004-F
Wire gauge	0.5~2.5mm ²	
Suit hoods/housings	H3A	





HA Series	10+ 	16+ 	32+ 
Technical data <ul style="list-style-type: none"> ◆ Rated current: 16A ◆ Rated voltage: 230/250V ◆ Terminal: Screw terminal 			
(M/F)	HA-010-M HA-010-F	HA-016-M HA-016-F	HA-016-M(1-16) HA-016-F(1-16) HA-016-M(17-32) HA-016-F(17-32)
Wire gauge	0.5~2.5mm ²		
Suit hoods/housings	H10A	H16A	H32A

HE Series	6+ 	10+ 	16+ 
Technical data <ul style="list-style-type: none"> ◆ Rated current: 16A ◆ Rated voltage: 400/500V ◆ Terminal: Screw terminal 			
(M/F)	HE-006-M HE-006-F	HE-010-M HE-010-F	HE-016-M HE-016-F
Wire gauge	0.5~4.0mm ²		
Suit hoods/housings	H6B	H10B	H16B

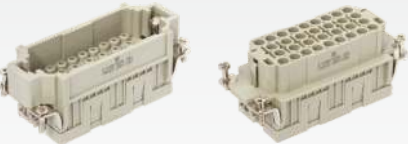





HE Series	24+ 	32+ 	48+ 
Technical data <ul style="list-style-type: none"> ◆ Rated current: 16A ◆ Rated voltage: 400/500V ◆ Terminal: Screw terminal 			
(M/F)	HE-024-M HE-024-F	HE-016-M(1-16) HE-016-F(1-16) HE-016-M(17-32) HE-016-F(17-32)	HE-024-M(1-24) HE-024-F(1-24) HE-024-M(25-48) HE-024-F(25-48)
Wire gauge	0.5~4.0mm ²		
Suit hoods/housings	H24B	H32B	H48B





HEE Series	10+ 	18+ 
Technical data ♦ Rated current: 16A ♦ Rated voltage: 500V ♦ Terminal: Crimp terminal		
	HEE-010-M HEE-010-F	HEE-018-M HEE-018-F
(M/F)		
Wire gauge	0.5~4.0mm ²	
Suit hoods/housings	H6B	







HEE Series	32+ 	46+ 
Technical data ♦ Rated current: 16A ♦ Rated voltage: 500V ♦ Terminal: Crimp terminal		
	HEE-032-M HEE-032-F	HEE-046-M HEE-046-F
(M/F)		
Wire gauge	0.5~4.0mm ²	
Suit hoods/housings	H16B	

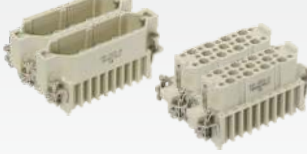

HEE Series	64+ 	92+ 
Technical data ♦ Rated current: 16A ♦ Rated voltage: 500V ♦ Terminal: Crimp terminal		
	HEE-032-M(1-32) HEE-032-F(1-32) HEE-032-M(33-64) HEE-032-F(33-64)	
(M/F)		
Wire gauge	0.5~4.0mm ²	
Suit hoods/housings	H32B	



	HEE	HEE
		
	CRIMPOBOX-0.5/4	HEE
		
		CEF CEM
Crimping wire range	0.5~4.0mm ²	



HD Series	7+ 	8+ 	15+ 			
Technical data <ul style="list-style-type: none"> ◆ Rated current: 10A ◆ Rated voltage: 250V ◆ Terminal: Crimp terminal 						
(M/F)	HD-007-M	HD-007-F	HD-008-M	HD-008-F	HD-015-M	HD-015-F
Wire gauge	0.5~2.5mm ²		0.5~2.5mm ²		0.5~2.5mm ²	
Suit hoods/housings	H3A		H3A		H10A	



HD Series	25+ 	40+ 	50+ 			
Technical data <ul style="list-style-type: none"> ◆ Rated current: 10A ◆ Rated voltage: 250V ◆ Terminal: Crimp terminal 						
(M/F)	HD-025-M	HD-025-F	HD-040-M	HD-040-F	HD-025-M(1-25)	HD-025-F(1-25)
Wire gauge	0.5~2.5mm ²		0.5~2.5mm ²		0.5~2.5mm ²	
Suit hoods/housings	H16A		H16B		H32A	



HD Series	64+ 	80+ 	128+ 			
Technical data <ul style="list-style-type: none"> ◆ Rated current: 10A ◆ Rated voltage: 250V ◆ Terminal: Crimp terminal 						
(M/F)	HD-064-M	HD-064-F	HD-040-M(1-40) HD-040-M(40-80)	HD-040-F(1-40) HD-040-F(40-80)	HD-064-M(1-64) HD-064-M(65-128)	HD-064-F(1-64) HD-064-F(65-128)
Wire gauge	0.5~2.5mm ²		0.5~2.5mm ²		0.5~2.5mm ²	
Suit hoods/housings	H24B		H32B		H48B	

	HD/HDD	HD/HDD
	 <p>CRIMPOBOX-0.5/4</p>	 <p>HD</p>
		 <p>CDF/CDM(10A)</p> <p>CDF</p> <p>CDM</p>
Crimping wire range	0.5~4.0mm ²	

HDD Series	24+ 	42+ 
Technical data <ul style="list-style-type: none"> ◆ Rated current: 10A ◆ Rated voltage: 250V ◆ Terminal: Crimp terminal 		
(M/F)	HDD-024-M HDD-024-F	HDD-042-M HDD-042-F
Wire gauge	0.5~2.5mm ²	
Suit hoods/housings	H6B	

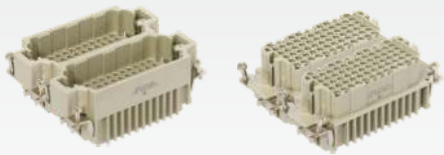
HDD Series	72+ 	108+ 
Technical data <ul style="list-style-type: none"> ◆ Rated current: 10A ◆ Rated voltage: 250V ◆ Terminal: Crimp terminal 		
(M/F)	HDD-072-M HDD-072-F	HDD-108-M HDD-108-F
Wire gauge	0.5~2.5mm ²	
Suit hoods/housings	H16B	

HDD Series	144+ 	216+ 
Technical data <ul style="list-style-type: none"> ◆ Rated current: 10A ◆ Rated voltage: 250V ◆ Terminal: Crimp terminal 		
(M/F)	HDD-072-M(1-72) HDD-072-F(1-72) HDD-072-M(73-144) HDD-072-F(73-144)	HDD-108-M(1-108) HDD-108-F(1-108) HDD-108-M(109-216) HDD-108-F(109-216)
Wire gauge	0.5~2.5mm ²	
Suit hoods/housings	H32B	





	HD/HDD	HD/HDD
	 <p>CRIMPOBOX-0.5/4</p>	 <p>HD</p>
		 <p>CDF/CDM(10A)</p> <p>CDF</p> <p>CDM</p>
Crimping wire range	0.5~4.0mm ²	



HEAV Series	6+		10+	
Technical data	<ul style="list-style-type: none"> ◆ Rated current: 16A ◆ Rated voltage: 500V 			
(M/F)				
	HEAV-006-M HEAV-006-F	HEAV-006-MS HEAV-006-FS	HEAV-010-M HEAV-010-F	HEAV-010-MS HEAV-010-FS
Terminal	Screw terminal	Spring terminal	Screw terminal	Spring terminal
Wire gauge	0.5~2.5mm ²	0.5~2.5mm ²	0.5~2.5mm ²	0.5~2.5mm ²
Suit hoods/housings	H6B		H10B	



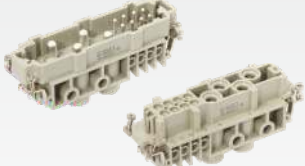

HEAV Series	16+		24+	
Technical data	<ul style="list-style-type: none"> ◆ Rated current: 16A ◆ Rated voltage: 500V 			
(M/F)				
	HEAV-016-M HEAV-016-F	HEAV-016-MS HEAV-016-FS	HEAV-024-M HEAV-024-F	HEAV-024-MS HEAV-024-FS
Terminal	Screw terminal	Spring terminal	Screw terminal	Spring terminal
Wire gauge	0.5~2.5mm ²	0.5~2.5mm ²	0.5~2.5mm ²	0.5~2.5mm ²
Suit hoods/housings	H16B		H24B	



HSB Series	6+		12+	
Technical data	<ul style="list-style-type: none"> ◆ Rated current: 35A ◆ Rated voltage: 500V 			
(M/F)				
	HSB-006-M HSB-006-F	HSB-006-M(1-6) HSB-006-M(7-12)	HSB-006-F(1-6) HSB-006-F(7-12)	
Terminal	Screw terminal		Screw terminal	
Wire gauge	0.5~6.0mm ²		0.5~6.0mm ²	
Suit hoods/housings	H16B		H32B	

HWK Series	HWK4/6+		HWK6/6+		HWK3/6/6+	
Technical data	<ul style="list-style-type: none"> ◆ Terminal: Screw terminal 					
(M/F)						
	HWK4/6-010-M HWK4/6-010-F	HWK6/6-012-M HWK6/6-012-F	HWK3/6/6-012-M HWK3/6/6-012-F			
Wire gauge	2.5~6.0mm ²	2.5~6.0mm ²	10.0~25.0mm ² , 4.0~10.0mm ²			
Wire gauge	1.0~2.5mm ²	1.0~2.5mm ²	1.0~2.5mm ²			
Suit hoods/housings	H16B		H16B		H24B	

HK Series	4/0+ 	4/2+ 	4/8+ 
Technical data ◆ 80A, 16A ◆ 690V, 400V			
(M/F)	HK4/0-004-M	HK4/0-004-F	HK4/8-012-M HK4/8-012-F
Terminal	Screw terminal		Screw terminal
Wire gauge	1.5~16.0mm ²		1.5~16.0mm ²
Wire gauge	0.5~2.5mm ²		0.5~2.5mm ²
Suit hoods/housings	H6B		H24B

HK Series	6/6+ 	6/12+ 	12/2+ 
Technical data ◆ 100A, 16A ◆ 690V, 400V			
(M/F)	HK6/6-012-M	HK6/6-012-F	HK12/2-014-M HK12/2-014-F
Terminal	Axial screw terminal		Crimp terminal
Wire gauge	16.0~35.0mm ²		2.5~6.0mm ²
Wire gauge	0.5~2.5mm ²		0.14~2.5mm ²
Suit hoods/housings	H24B		H6B

HK Series	6/36+ 	8/24+ 	
Technical data ◆ 40A, 16A ◆ 690V, 250V			
(M/F)	HK6/36-036-M	HK6/36-036-F	
Terminal	Crimp terminal		Crimp terminal
Wire gauge	1.5~6.0mm ²		0.5~4.0mm ²
Wire gauge	0.14~2.5mm ²		0.14~2.5mm ²
Suit hoods/housings	H16B		H10B

HQ Series	5+ 	7+ 	8+ 
Technical data ◆ Rated current: 16A ◆ Rated voltage: 400V ◆ Terminal: Crimp terminal Order crimp contacts separately			
(M/F)	HQ-005-M	HQ-005-F	HQ-008-M HQ-008-F
Wire gauge	0.5~2.5mm ²		0.5~4.0mm ²
Suit hoods/housings	H3A		H8A

Technical parameters

Number of modules	2,3,4,6
Ground wire	
-Power line	4~6mm
	AWG 12~8
-Signal cable	1~2.5mm
	AWG 18~14
Material	Die-cast zinc alloy
range of working temperature	-40°C~+125°C
Pluggable Times	≥500

Schematic diagram of module disassembly

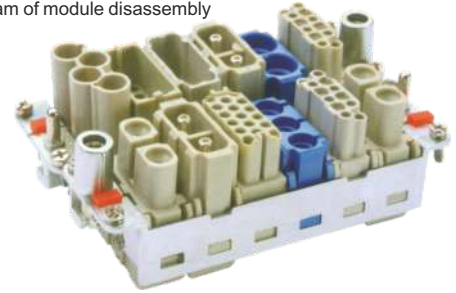

6B Movable frame for all 6B enclosures



Description	Mark	Model
For 2 modules	A-B	HF6B-NUA2
For 2 modules	a-b	HF6B-NLA2

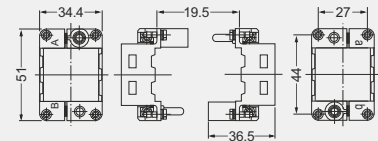

10B Movable frame for all 10B enclosures

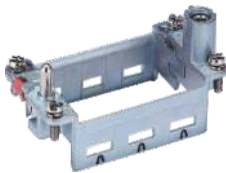

Description	Mark	Model
For 3 modules	A-C	HF10B-NUA2
For 3 modules	a-c	HF10B-NLA2

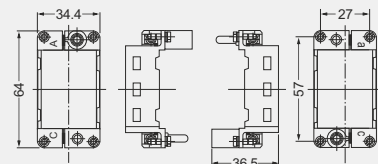

16B Movable frame for all 16B enclosures

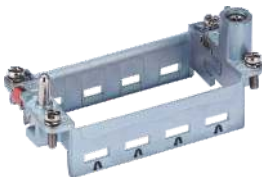

Description	Mark	Model
For 4 modules	A-D	HF16B-NUA2
For 4 modules	a-d	HF16B-NLA2

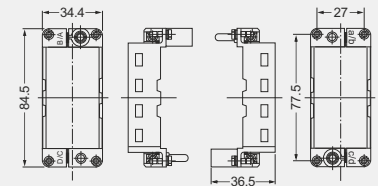

24B Movable frame for all 24B shells



Description	Mark	Model
For 6 modules	A-F	HF24B-NUA2
For 6 modules	a-f	HF24B-NLA2

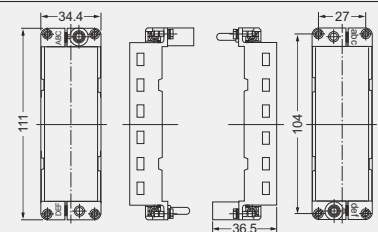







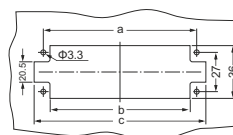

Fixed blocks (2 pcs per frame)

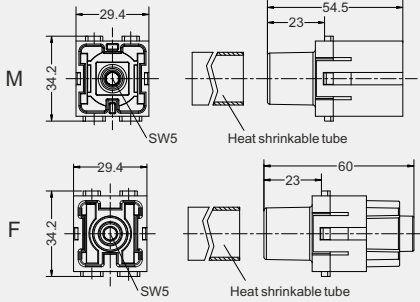

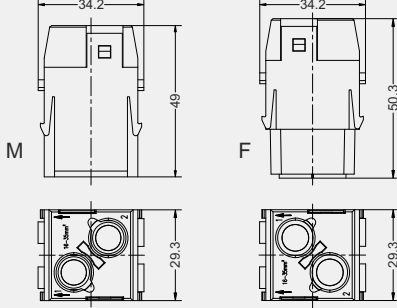

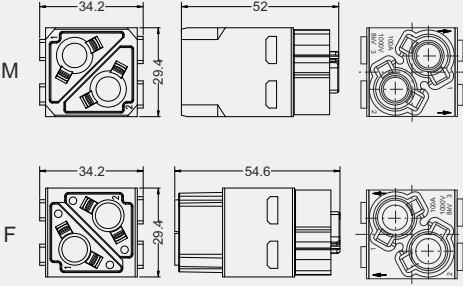

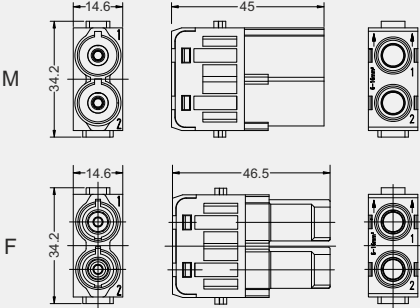

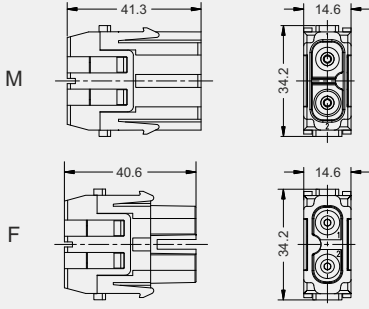

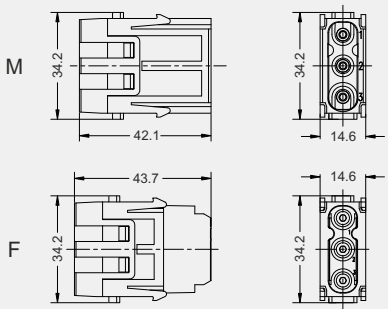

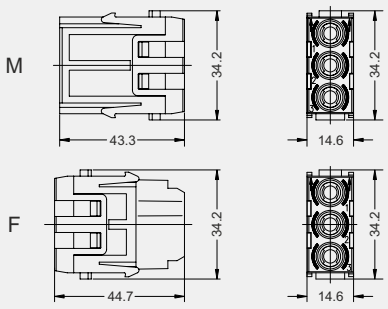

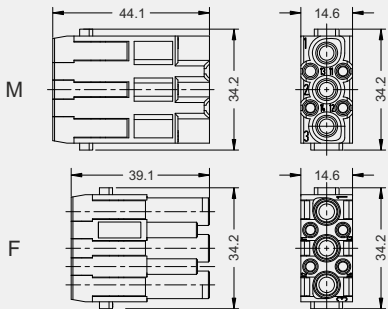

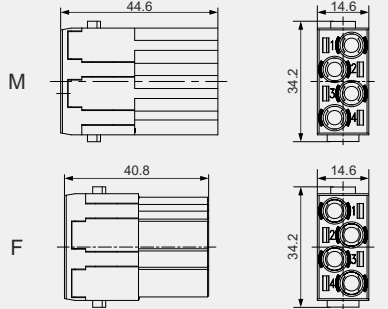

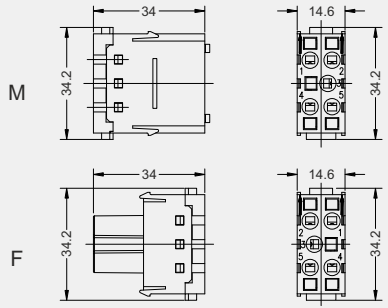
Description	Model
Fixed frame prevents Loose module	HF-LE2



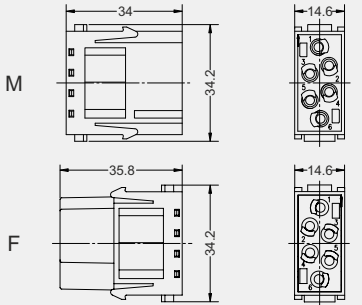

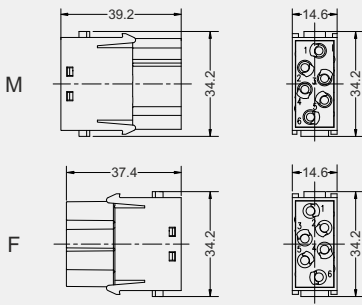

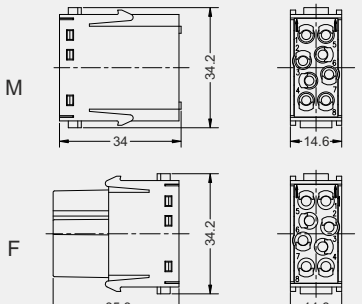
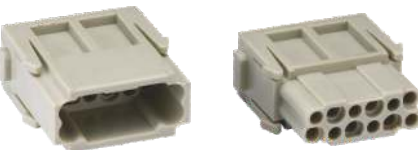
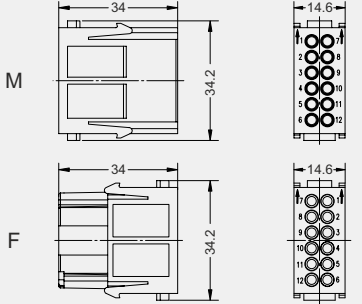
尺寸	a	b	c
HZW-H6	44	35	52
HZW-10	57	49	66
HZW-16	77.5	64	85.5
HZW-24	104	94	112

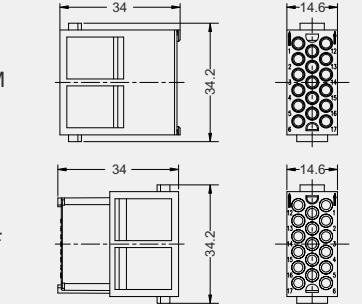
Type of products	Technical Parameters	Dimension
 <p>H2MK-001.1-M H2MK-001.1-F(25-40mm²) H2MK-001.2-M H2MK-001.2-F(40-70mm²)</p>	<p>Working current: 200A Working voltage: 1000V Rate impulse voltage: 8kV Pollution degree: 3</p> <p>Terminal: Crimp terminal Wire gauge: 25~70mm² Hexagonal driver: SW-5×150</p>	
 <p>H2MK-002.1-M H2MK-002.1-F(10-25mm²) H2MK-002.2-M H2MK-002.2-F(16-35mm²)</p>	<p>Working current: 100A Working voltage: 1000V Rate impulse voltage: 8kV Pollution degree: 3</p> <p>Terminal: Axial screw terminal Wire gauge: 10~35mm² Hexagonal driver: SW-4×100</p>	
 <p>H2MK-002-MC H2MK-002-FC</p>	<p>Working current: 100A Working voltage: 1000V Rate impulse voltage: 8kV Pollution degree: 3</p> <p>Terminal: Crimp terminal Wire gauge: 16~35mm²</p>	
 <p>HMK70-002.1-M HMK70-002.1-F(6-16mm²) HMK70-002.2-M HMK70-002.2-F(14-22mm²)</p>	<p>Working current: 70A Working voltage: 1000V Rate impulse voltage: 8kV Pollution degree: 3</p> <p>Terminal: Axial screw terminal Wire gauge: 6~22mm² Hexagonal driver: SW-2.5×100</p>	
 <p>HMK-002.1-M HMK-002.1-F(2.5-8mm²) HMK-002.2-M HMK-002.2-F(6-10mm²)</p>	<p>Working current: 40A Working voltage: 1000V Rate impulse voltage: 8kV Pollution degree: 3</p> <p>Terminal: Axial screw terminal Wire gauge: 2.5~10mm² Hexagonal driver: SW-2×40</p>	

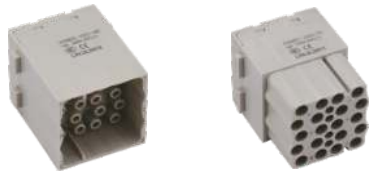
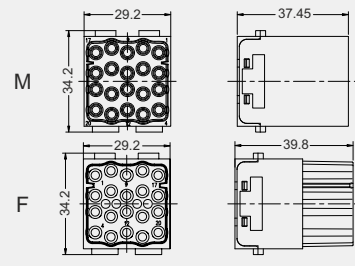
Type of products	Technical Parameters	Dimension
 <p>HMK-003.1-M HMK-003.2-M</p>	<p>Working current: 40A Working voltage: 690V Rate impulse voltage: 8kV Pollution degree: 3</p> <p>Terminal: Axial screw terminal Wire gauge: 2.5~10mm² Hexagonal driver: SW-2×40</p>	 <p>M: 34.2, 42.1 F: 34.2, 43.7 Side view of pin arrangement / wiring</p>
 <p>HMK-003-MC HMK-003-FC</p>	<p>Working current: 40A Working voltage: 1500V Rate impulse voltage: 6kV Pollution degree: 3</p> <p>Terminal: Crimp terminal Wire gauge: 1.5~6mm²</p>	 <p>M: 34.2, 43.3 F: 34.2, 44.7 Side view of pin arrangement / wiring</p>
 <p>HMK-003/4-MC HMK-003/4-FC</p>	<p>Working current Power area: 40A Signal area: 10A Working voltage: 830V Rate impulse voltage: 8kV Pollution degree: 3</p> <p>Terminal: Crimp terminal Wire gauge Power area: 1.5~6mm² Signal area: 0.14~2.5mm²</p>	 <p>M: 44.1, 34.2 F: 39.1, 34.2 Side view of pin arrangement / wiring</p>
 <p>HMK-004-MC HMK-004-FC</p>	<p>Working current: 40A Working voltage: 830V Rate impulse voltage: 8kV Pollution degree: 3</p> <p>Terminal: Crimp terminal Wire gauge: 1.5~6mm²</p>	 <p>M: 44.6, 34.2 F: 40.8, 34.2 Side view of pin arrangement / wiring</p>
 <p>HME-005-MS HME-005-FS</p>	<p>Working current: 16A Working voltage: 400V Rate impulse voltage: 6kV Pollution degree: 3</p> <p>Terminal: Cage-clamp terminal Wire gauge: 0.14~2.5mm²</p>	 <p>M: 34, 34.2 F: 34, 34.2 Side view of pin arrangement / wiring</p>

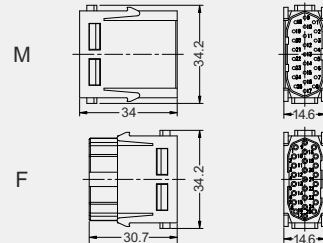
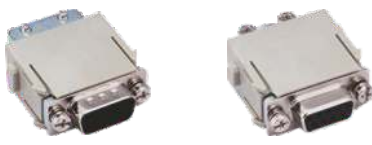
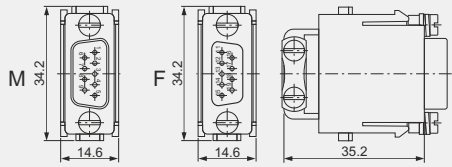
Type of products	Technical Parameters	Dimension
 <p>HME-006-MC HME-006-FC</p>	<p>Working current: 16A Working voltage: 500V Rate impulse voltage: 6kV Pollution degree: 3</p> <p>Terminal: Crimp terminal Wire gauge: 0.14~4mm² Code pin: CODE-E</p>	 <p>M</p> <p>F</p> <p>Side view of pin arrangement / wiring</p>
 <p>HVME-006-MC HVME-006-FC</p>	<p>Working current: 16A Working voltage: 830V Rate impulse voltage: 8kV Pollution degree: 3</p> <p>Terminal: Crimp terminal Wire gauge: 0.14~4mm² Code pin: CODE-E</p>	 <p>M</p> <p>F</p> <p>Side view of pin arrangement / wiring</p>
 <p>HMEE-008-MC HMEE-008-FC</p>	<p>Working current: 16A Working voltage: 400V Rate impulse voltage: 6kV Pollution degree: 3</p> <p>Terminal: Crimp terminal Wire gauge: 0.14~4mm² Code pin: CODE-E</p>	 <p>M</p> <p>F</p> <p>Side view of pin arrangement / wiring</p>
 <p>HMD-012-MC HMD-012-FC</p>	<p>Working current: 10A Working voltage: 250V Rate impulse voltage: 4kV Pollution degree: 3</p> <p>Terminal: Crimp terminal Wire gauge: 0.14~2.5mm²</p>	 <p>M</p> <p>F</p> <p>Side view of pin arrangement / wiring</p>
 <p>HMDD-017-MC HMDD-017-FC</p>	<p>Working current: 10A Working voltage: 160V Rate impulse voltage: 2.5kV Pollution degree: 3</p> <p>Terminal: Crimp terminal Wire gauge: 0.14~2.5mm²</p>	 <p>M</p> <p>F</p> <p>Side view of pin arrangement / wiring</p>

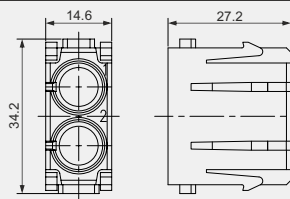
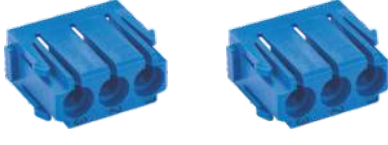
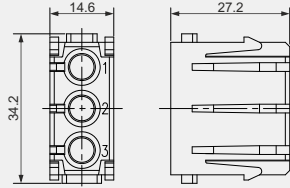
Type of products	Technical Parameters	Dimension
 <p>H2MEE-020-MC H2MEE-020-FC</p>	<p>Working current: 16A Working voltage: 500V Rate impulse voltage: 6kV Pollution degree: 3</p> <p>Terminal: Crimp terminal Wire gauge: 0.14~4mm²</p>	 <p>M: 29.2, 34.2, 37.45 F: 29.2, 34.2, 39.8</p>
 <p>HMDS-025-MC HMDS-025-FC</p>	<p>Working current: 5A Working voltage: 50V Rate impulse voltage: 0.8kV Pollution degree: 3</p>	 <p>M: 34.2, 34 F: 34.2, 30.7, 14.6</p>
<p>D-Sub</p>  <p>HMDS-009-MC HMDS-009-FC</p>	<p>Working current: 5A Working voltage: 50V Rate impulse voltage: 0.8kV Pollution degree: 3</p>	 <p>M: 34.2, 14.6 F: 34.2, 14.6, 35.2</p>
<p>Pneumatic module</p>  <p>HMP-002 HMP-002</p>	<p>Number of contacts: 2 Material: PC Flammability acc.to UI94: V0 Mechanical working life: ≥500 Material: POM Diameter: 6.0mm/1/4 Working pressure: Max 8 bar/116 psi</p>	 <p>14.6, 27.2, 34.2</p>
 <p>HMP-003 HMP-003</p>	<p>Number of contacts: 3 Material: PC Flammability acc.to UI94: V0 Mechanical working life: ≥500 Material: POM Diameter: 1.6mm/1/16" Working pressure: Max 8 bar/116 psi</p>	 <p>14.6, 27.2, 34.2</p>

Accessories

For Tubeinternal Diameter ID

Description	Category	ID	型号	Dimensions	
				M	F
	Public	1.6mm	PCM-1.6	19.4	22.8
		3.0mm	PCM-1.6	20.4	25.5
		4.0mm	PCM-1.6	22.6	22.8
	Mother	1.6mm	PCF-1.6	20.4	25.5
		3.0mm	PCF-1.6	22.6	22.8
		4.0mm	PCF-1.6	22.6	22.8

For Tubeinternal Diameter ID

Description	Category	ID	型号	Dimensions	
	Mother	1.6mm	PCFS-1.6	22.8	25.5
		3.0mm	PCFS-1.6	22.8	25.5
		4.0mm	PCFS-1.6	22.8	25.5

16A Crimp contacts

Technical data

- ◆ Material: copper
- ◆ Contact resistance: $\leq 1m\Omega$
- ◆ Terminal: crimp connection

Male crimp contacts

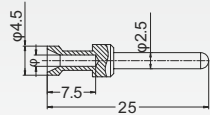

Wire gauge	Stripping length	Contacts, Silver-plated	Contacts, Gold-plated	
0.5 mm ²	AWG 20	7.5mm	CEM-0.5	DEM-0.5
0.75 mm ²	AWG 18	7.5mm	CEM-0.75	DEM-0.75
1.0 mm ²	AWG 18	7.5mm	CEM-1.0	DEM-1.0
1.5 mm ²	AWG 16	7.5mm	CEM-1.5	DEM-1.5
2.5 mm ²	AWG 14	7.5mm	CEM-2.5	DEM-2.5
4.0 mm ²	AWG 12	7.5mm	CEM-4.0	DEM-4.0

Female crimp contacts

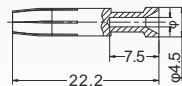

Wire gauge	Stripping length	Contacts, Silver-plated	Contacts, Gold-plated	
0.5 mm ²	AWG 20	7.5mm	CEM-0.5	DEM-0.5
0.75 mm ²	AWG 18	7.5mm	CEM-0.75	DEM-0.75
1.0 mm ²	AWG 18	7.5mm	CEM-1.0	DEM-1.0
1.5 mm ²	AWG 16	7.5mm	CEM-1.5	DEM-1.5
2.5 mm ²	AWG 14	7.5mm	CEM-2.5	DEM-2.5
4.0 mm ²	AWG 12	7.5mm	CEM-4.0	DEM-4.0

10A Crimp contacts

Technical data

- ◆ Material: copper
- ◆ Contact resistance: $\leq 3m\Omega$
- ◆ Terminal: crimp connection

Male crimp contacts

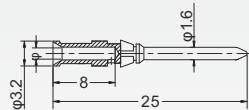

Wire gauge	Stripping length	Contacts, Silver-plated	Contacts, Gold-plated	
0.5 mm ²	AWG 20	8.0mm	CDM-0.5	DDM-0.5
0.75 mm ²	AWG 18	8.0mm	CDM-0.75	DDM-0.75
1.0 mm ²	AWG 18	8.0mm	CDM-1.0	DDM-1.0
1.5 mm ²	AWG 16	8.0mm	CDM-1.5	DDM-1.5
2.5 mm ²	AWG 14	8.0mm	CDM-2.5	DDM-2.5

Female crimp contacts

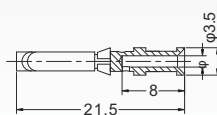

Wire gauge	Stripping length	Contacts, Silver-plated	Contacts, Gold-plated	
0.5 mm ²	AWG 20	8.0mm	CDF-0.5	DDF-0.5
0.75 mm ²	AWG 18	8.0mm	CDF-0.75	DDF-0.75
1.0 mm ²	AWG 18	8.0mm	CDF-1.0	DDF-1.0
1.5 mm ²	AWG 16	8.0mm	CDF-1.5	DDF-1.5
2.5 mm ²	AWG 14	8.0mm	CDF-2.5	DDF-2.5

40A Crimp contacts

Technical data

- ◆ Material: copper
- ◆ Contact resistance: $\leq 4m\Omega$
- ◆ Terminal: crimp connection

Male crimp contacts

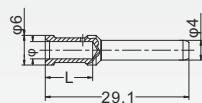

Wire gauge	Stripping length	Contacts, Silver-plated	Contacts, Gold-plated	
1.75 mm ²	AWG 16	8.0mm	CMM-1.5	DMM-1.5
2.25 mm ²	AWG 14	8.0mm	CMM-2.5	DMM-2.5
2.85 mm ²	AWG 12	8.0mm	CMM-4.0	DMM-4.0
3.50 mm ²	AWG 10	8.0mm	CMM-6.0	DMM-6.0

Female crimp contacts

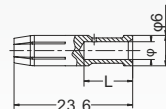

Wire gauge	Stripping length	Contacts, Silver-plated	Contacts, Gold-plated	
1.75 mm ²	AWG 16	8.0mm	CMF-1.5	DMF-1.5
2.25 mm ²	AWG 14	8.0mm	CMF-2.5	DMF-2.5
2.85 mm ²	AWG 12	8.0mm	CMF-4.0	DMF-4.0
3.50 mm ²	AWG 10	8.0mm	CMF-6.0	DMF-6.0

Crimping tool and removal tool

Technical data

- ◆ Crimping tool: crimping wire range 0.5~4.0mm²
- ◆ For HD/HDD, HEE crimp contacts



CRIMPBOX-0.5/4
Crimping tool



REMOV-HEE
HEE series crimp contact removal tool



REMOV-HD
HD/HDD series crimp contact removal tool

Degree of protection: IP65

Hoods

Top entry



Thread	Type
M20	H3A-TE-2B-M20
PG11	H3A-TE-2B-PG11
PG13.5	H3A-TE-2B-PG13.5

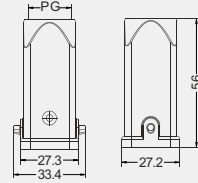

Side entry



Thread	Type
M20	H3A-SE-2B-M20
PG11	H3A-SE-2B-PG11
PG13.5	H3A-SE-2B-PG13.5

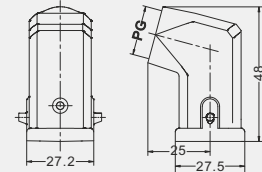

Bulkhead mounting



Thread	Type
---	H3A-BK-1LW-MCV/M
---	H3A-BK-1LW-MCV/F

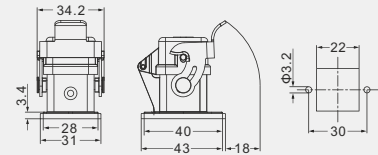

Housings

Bulkhead mounting: Bottom entry



Thread	Type
---	H3A-BK-1LW

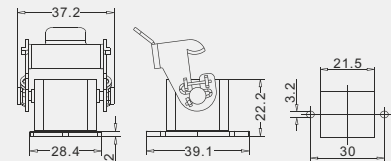

Bulkhead mounting: Bottom entry



Thread	Type
---	H3A-BK-1LW-SE

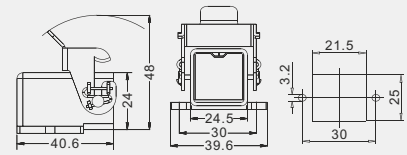

Surface mounting: Side entry



Thread	Type
M20	H3A-SF-1LW-M20
PG11	H3A-SF-1LW-PG11
PG13.5	H3A-SF-1LW-PG13.5

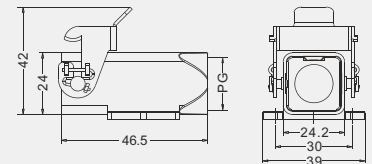

Cable-to cable hood



Thread	Type
M20	H3A-CCT-1LW-M20
PG11	H3A-CCT-1LW-PG11
PG13.5	H3A-CCT-1LW-PG13.5

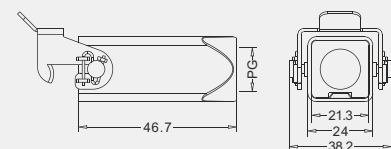

Degree of protection: IP65

Hoods

Side entry



Thread	Type
M20	H10A-SE-2B-M20
PG16	H10A-SE-2B-PG16
High construction	
M25	H10A-SEH-2B-M25
PG16	H10A-SEH-2B-PG16
PG21	H10A-SEH-2B-PG21

Low construction

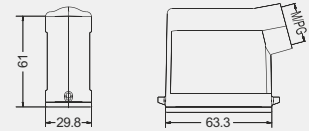

High construction

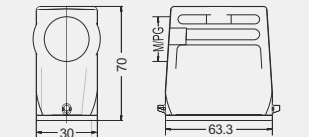

Top entry



Thread	Type
M20	H10A-TE-2B-M20
PG13.5	H10A-TE-2B-PG13.5
High construction	
M25	H10A-TE-2B-M25
PG16	H10A-TE-2B-PG16
PG21	H10A-TE-2B-PG21

Low construction

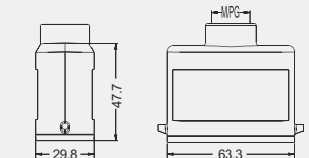

High construction

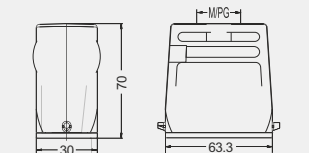

Housings

Bulkhead: Mounted



Thread	Type
Without protection covers	
	H10A-BK-1L
With protection covers	
	H10A-BK-1L-CV

With protection covers

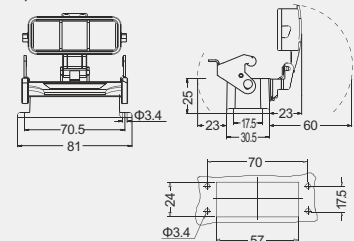

Surface mounted: Side entry



Thread	Type
M20	H10A-SF-1L-M20
2M20	H10A-SF-1L-2M20
M25	H10A-SF-1L-M25
PG16	H10A-SF-1L-PG16
2PG16	H10A-SF-1L-2PG16
PG21	H10A-SF-1L-PG21
With plastic cover	
M20	H10A-SF-1L-CV-M20
2M20	H10A-SF-1L-CV-2M20
M25	H10A-SF-1L-CV-M25
PG16	H10A-SF-1L-CV-PG16
2PG16	H10A-SF-1L-CV-2PG16
PG21	H10A-SF-1L-CV-PG21
With metal cover	
M20	H10A-SF-1L-MCV-M20
2M20	H10A-SF-1L-MCV-2M20
M25	H10A-SF-1L-MCV-M25
PG16	H10A-SF-1L-MCV-PG16
2PG16	H10A-SF-1L-MCV-2PG16
PG21	H10A-SF-1L-MCV-PG21

Without protection covers

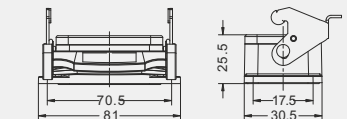

Without protection covers

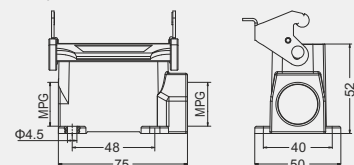

With protection covers

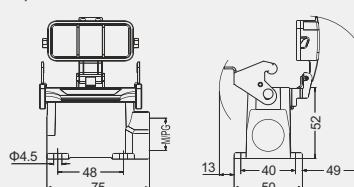

Degree of protection: IP65

Hoods

Side entry



Thread	Type
M20	H16A-SE-2B-M20
PG16	H16A-SE-2B-PG16
High construction	
M25	H16A-SEH-2B-M25
PG16	H16A-SEH-2B-PG16
PG21	H16A-SEH-2B-PG21

Low construction

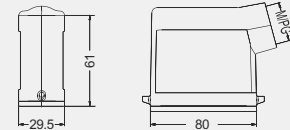

High construction

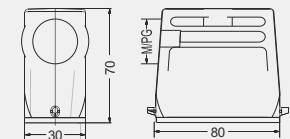

Top entry



Thread	Type
M20	H16A-TE-2B-M20
PG16	H16A-TE-2B-PG16
High construction	
M25	H16A-TEH-2B-M25
PG16	H16A-TEH-2B-PG16
PG21	H16A-TEH-2B-PG21

Low construction

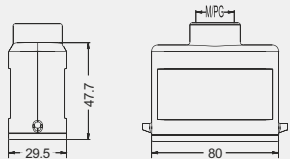

High construction

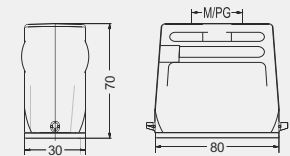

Housings

Bulkhead: Mounted



Thread	Type
Without protection covers	
	H16A-BK-1L
With protection covers	
	H16A-BK-1L-CV

With protection covers

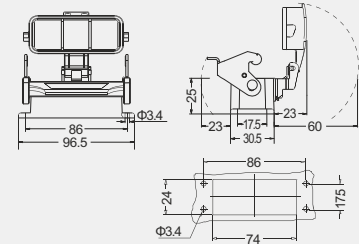

Surface mounted: Side entry



Thread	Type
M20	H16A-SF-1L-M20
2M20	H16A-SF-1L-2M20
M25	H16A-SF-1L-M25
2M25	H16A-SF-1L-2M25
PG16	H16A-SF-1L-PG16
2PG16	H16A-SF-1L-2PG16
PG21	H16A-SF-1L-PG21
With plastic cover	
M20	H16A-SF-1L-CV-M20
2M20	H16A-SF-1L-CV-2M20
M25	H16A-SF-1L-CV-M25
2M25	H16A-SF-1L-CV-2M25
PG16	H16A-SF-1L-CV-PG16
2PG16	H16A-SF-1L-CV-2PG16
PG21	H16A-SF-1L-CV-PG21
With metal cover	
M20	H16A-SF-1L-MCV-M20
2M20	H16A-SF-1L-MCV-2M20
M25	H16A-SF-1L-MCV-M25
2M25	H16A-SF-1L-MCV-2M25
PG16	H16A-SF-1L-MCV-PG16
2PG16	H16A-SF-1L-MCV-2PG16
PG21	H16A-SF-1L-MCV-PG21

Without protection covers

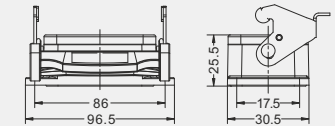

Without protection covers

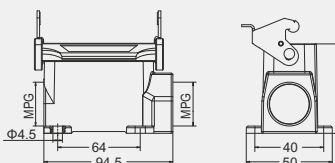

With protection covers

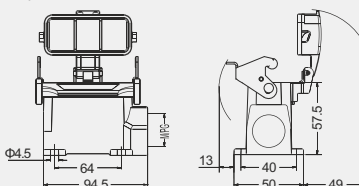

Degree of protection: IP65

Hoods

Side entry



Thread	Type
PG21	H32A-SEH-4B-PG21
PG29	H32A-SEH-4B-PG29
M25	H32A-SEH-4B-M25
M32	H32A-SEH-4B-M32

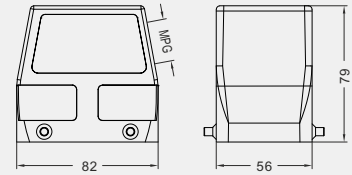

Hood: Top entry



Thread	Type
PG21	H32A-TEH-4B-PG21
PG29	H32A-TEH-4B-PG29
M25	H32A-TEH-4B-M25
M32	H32A-TEH-4B-M32

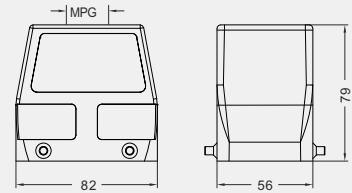

Housings

Bulkhead mounting



Thread	Type
---	H32A-BK-2L

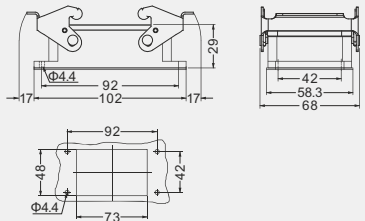

Surface mounting



Thread	Type
M25	H32A-SF-2L-M25
M32	H32A-SF-2L-M32
2M32	H32A-SF-2L-2M32
PG21	H32A-SF-2L-PG21
2PG21	H32A-SF-2L-2PG21
PG29	H32A-SF-2L-PG29
2PG29	H32A-SF-2L-2PG29

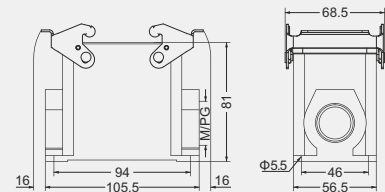

Protection covers Plastic cover 4 clamps



Wiring	Applications	Type
	For upper shell	H32A-CV-4C

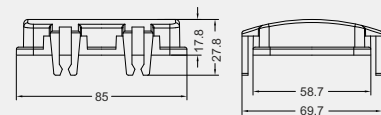

Protection covers Plastic cover



Wiring	Applications	Type
	For cable connection	H32A-CV-4B/1
	For lower case	H32A-CV-4B/2

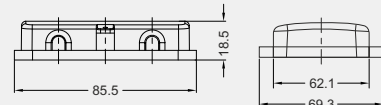

Degree of protection: IP65

Hoods

Side entry



Thread	Type
PG13.5	H6B-SE-2B-PG13.5
PG16	H6B-SE-2B-PG16
M20	H6B-SE-2B-M20
M25	H6B-SE-2B-M25

Low construction

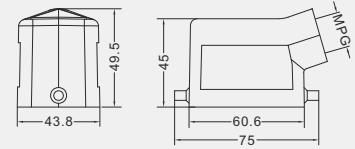

Side entry



Thread	Type
PG21	H6B-SEH-2B-PG21
PG29	H6B-SEH-2B-PG29
M25	H6B-SEH-2B-M25
M32	H6B-SEH-2B-M32

High construction

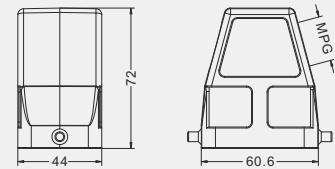

Top entry



Thread	Type
PG13.5	H6B-TE-2B-PG13.5
PG16	H6B-TE-2B-PG16
M20	H6B-TE-2B-M20

Low construction

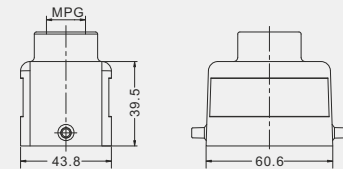

Top entry



Thread	Type
PG21	H6B-TEH-2B-PG21
PG29	H6B-TEH-2B-PG29
M25	H6B-TEH-2B-M25
M32	H6B-TEH-2B-M32

High construction

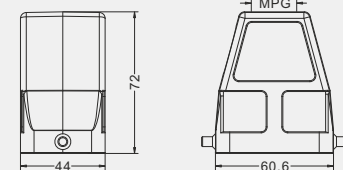

Housings

Bulkhead: Mounted



Thread	Type
M20	H6B-SF-1L-M20
2M20	H6B-SF-1L-2M20
M25	H6B-SF-1L-M25
2M25	H6B-SF-1L-2M25
PG16	H6B-SF-1L-PG16
2PG16	H6B-SF-1L-2PG16
With plastic cover	
M20	H6B-SF-1L-CV-M20
2M20	H6B-SF-1L-CV-2M20
M25	H6B-SF-1L-CV-M25
2M25	H6B-SF-1L-CV-2M25
PG16	H6B-SF-1L-CV-PG16
2PG16	H6B-SF-1L-CV-2PG16
With metal cover	
M20	H6B-SF-1L-MCV-M20
2M20	H6B-SF-1L-MCV-2M20
M25	H6B-SF-1L-MCV-M25
2M25	H6B-SF-1L-MCV-2M25
PG16	H6B-SF-1L-MCV-PG16
2PG16	H6B-SF-1L-MCV-2PG16

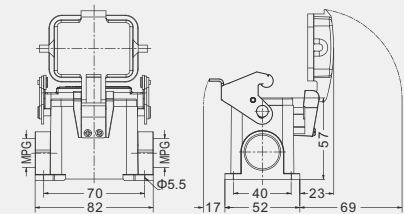

Degree of protection: IP65

Housings

Surface mounted: Side entry



Thread	Type
---	H6B-BK-1L
	<i>With plastic cover</i>
---	H6B-BK-1L-CV
	<i>With metal cover</i>
---	H6B-BK-1L-MCV

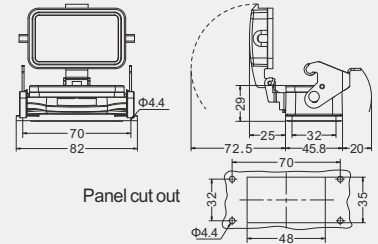

Panel cut out

Surface mounted: Side entry



Thread	Type
M25	H6B-SFH-1L-M25
2M25	H6B-SFH-1L-2M25
M32	H6B-SFH-1L-M32
2M32	H6B-SFH-1L-2M32
PG21	H6B-SFH-1L-PG21
2PG21	H6B-SFH-1L-2PG21
PG29	H6B-SFH-1L-PG29
2PG29	H6B-SFH-1L-2PG29
	<i>With plastic cover</i>
M25	H6B-SF-1L-CV-M25
2M25	H6B-SF-1L-CV-2M25
M32	H6B-SF-1L-CV-M32
2M32	H6B-SF-1L-CV-2M32
PG21	H6B-SF-1L-CV-PG21
2PG21	H6B-SF-1L-CV-2PG21
PG29	H6B-SF-1L-CV-PG29
2PG29	H6B-SF-1L-CV-2PG29
	<i>With metal cover</i>
M25	H6B-SF-1L-CV-M25
2M25	H6B-SF-1L-CV-2M25
M32	H6B-SF-1L-CV-M32
2M32	H6B-SF-1L-CV-2M32
PG21	H6B-SF-1L-CV-PG21
2PG21	H6B-SF-1L-CV-2PG21
PG29	H6B-SF-1L-CV-PG29
2PG29	H6B-SF-1L-CV-2PG29

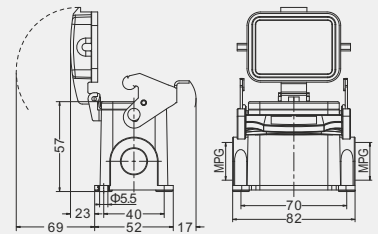

Housings Cable to cable



Thread	Type
M20	H6B-CCT-1L-M20
M25	H6B-CCT-1L-M25
PG13.5	H6B-CCT-1L-PG13.5
PG16	H6B-CCT-1L-PG16

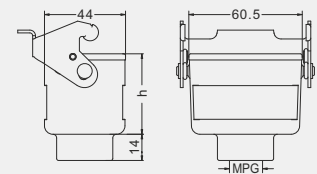

	h
Low construction	42
High construction	72

Housings Cable to cable



Thread	Type
M13.5	H6B-CCTH-1L-M13.5
M20	H6B-CCTH-1L-M20
M25	H6B-CCTH-1L-M25
PG21	H6B-CCTH-1L-PG21
PG29	H6B-CCTH-1L-PG29

High construction

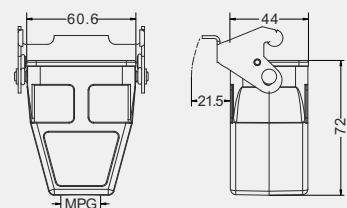

Protection covers for housings



Thread	Type
---	H6B-CV-2C

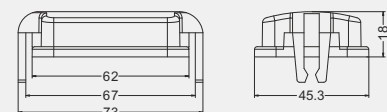

Degree of protection: IP65

Hoods

Side entry



Thread	Type
M20	H10B-SE-4B-M20
M25	H10B-SE-4B-M25
PG16	H10B-SE-4B-PG16

Low construction

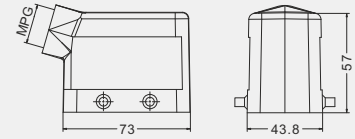

Side entry



Thread	Type
M20	H10B-SEH-4B-M20
M25	H10B-SEH-4B-M25
M32	H10B-SEH-4B-M32
PG16	H10B-SEH-4B-PG16
PG21	H10B-SEH-4B-PG21
PG29	H10B-SEH-4B-PG29

High construction

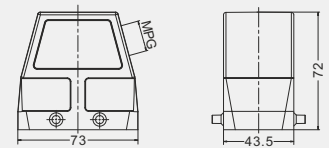

Top entry



Thread	Type
M20	H10B-TE-4B-M20
M25	H10B-TE-4B-M25
PG16	H10B-TE-4B-PG16

Low construction

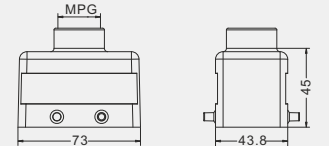

Top entry



Thread	Type
M20	H10B-TEH-4B-M20
M25	H10B-TEH-4B-M25
M32	H10B-TEH-4B-M32
PG16	H10B-TEH-4B-PG16
PG21	H10B-TEH-4B-PG21
PG29	H10B-TEH-4B-PG29

High construction

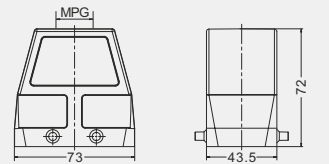

Housings

Housings, bulkhead mounting



Thread	Type
---	H10B-BK-2L

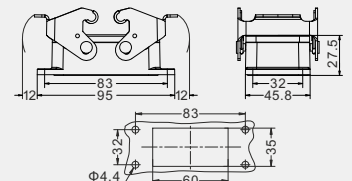

Housings, surface mounting



Thread	Type
M20	H10B-SF-2L-M20
2M20	H10B-SF-2L-2M20
M25	H10B-SF-2L-M25
2M25	H10B-SF-2L-2M25
PG16	H10B-SF-2L-PG16
2PG16	H10B-SF-2L-2PG16

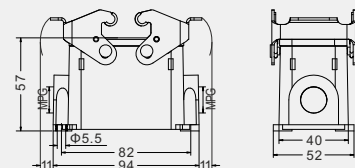

Housings Cable to cable



Thread	Type
M20	HV10B-CCT-1L-M20
PG16	HV10B-CCT-1L-PG16

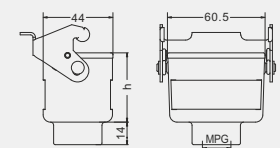

	h
Low construction	42
High construction	72

Degree of protection: IP65

Housings

Housings Cable to cable



Thread	Type
M25	H10B-CCTH-1L-M25
M32	H10B-CCTH-1L-M32
PG21	H10B-CCTH-1L-PG21
PG29	H10B-CCTH-1L-PG29

High construction

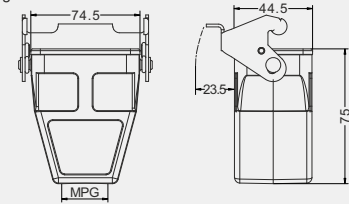

Hoods

Side entry housing with two levers



Thread	Type
M20	H10B-SE-2L-M20
M25	H10B-SE-2L-M25
PG16	H10B-SE-2L-PG16

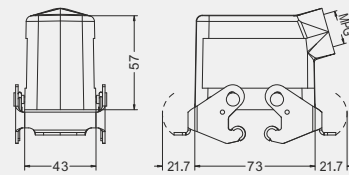

Top entry housing with two levers



Thread	Type
PG16	H10B-TE-2L-PG16
M20	H10B-TE-2L-M20
M25	H10B-TE-2L-M25

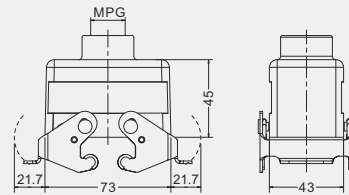

Housings

Bulkhead mounted with 4 bolts



Thread	Type
---	H10B-BK-4B
---	With plastic cover
---	H10B-BK-4B-CV
---	With metal cover
---	H10B-BK-4B-MCV

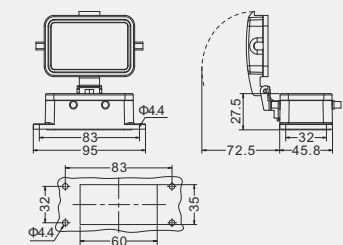

Surface mounting with 4 bolts



Thread	Type
M20	H10B-SF-4B-M20
2M20	H10B-SF-4B-2M20
M25	H10B-SF-4B-M25
2M25	H10B-SF-4B-2M25
PG16	H10B-SF-4B-PG16
2PG16	H10B-SF-4B-2PG16
---	With plastic cover
M20	H10B-SF-4B-CV-M20
2M20	H10B-SF-4B-CV-2M20
M25	H10B-SF-4B-CV-M25
2M25	H10B-SF-4B-CV-2M25
PG16	H10B-SF-4B-CV-PG16
2PG16	H10B-SF-4B-CV-2PG16
---	With metal cover
M20	H10B-SF-4B-MCV-M20
2M20	H10B-SF-4B-MCV-2M20
M25	H10B-SF-4B-MCV-M25
2M25	H10B-SF-4B-MCV-2M25
PG16	H10B-SF-4B-MCV-PG16
2PG16	H10B-SF-4B-MCV-2PG16

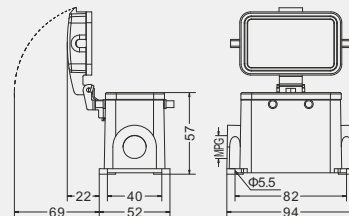

Degree of protection: IP65

Hoods

Side entry



Thread	Type
M20	H10B-SE-2B-M20
M25	H10B-SE-2B-M25
PG16	H10B-SE-2B-PG16

Low construction

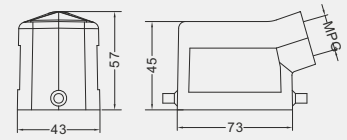

Side entry



Thread	Type
M20	H10B-SEH-2B-M20
M25	H10B-SEH-2B-M25
M32	H10B-SEH-2B-M32
PG13.5	H10B-SEH-2B-PG13.5
PG21	H10B-SEH-2B-PG21
PG29	H10B-SEH-2B-PG29

High construction

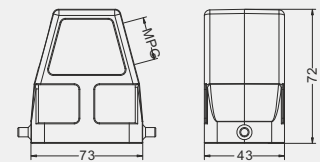

Top entry



Thread	Type
M20	H10B-TE-2B-M20
M25	H10B-TE-2B-M25
PG16	H10B-TE-2B-PG16

Low construction

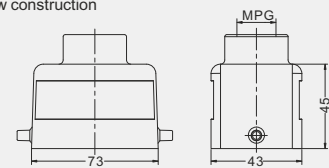

Top entry



Thread	Type
M20	HV10B-TEH-2B-M20
M25	HV10B-TEH-2B-M25
M32	HV10B-TEH-2B-M32
PG13.5	HV10B-TEH-2B-PG13.5
PG16	HV10B-TEH-2B-PG16
PG21	HV10B-TEH-2B-PG21
PG29	HV10B-TEH-2B-PG29

High construction

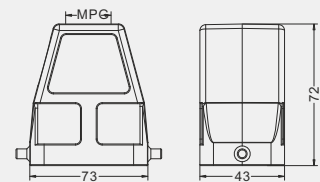

Housings

Housings, bulkhead mounting



Thread	Type
---	H10B-BK-1L
---	With plastic cover
---	H10B-BK-1L-CV
---	With metal cover
---	H10B-BK-1L-MCV

With protection covers

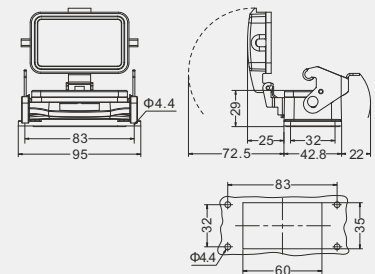

Housings, surface mounting



Thread	Type
M20	H10B-SF-1L-M20
2M20	H10B-SF-1L-2M20
M25	H10B-SF-1L-M25
2M25	H10B-SF-1L-2M25
PG16	H10B-SF-1L-PG16
2PG16	H10B-SF-1L-2PG16
---	With plastic cover
M20	H10B-SF-1L-CV-M20
2M20	H10B-SF-1L-CV-2M20
M25	H10B-SF-1L-CV-M25
2M25	H10B-SF-1L-CV-2M25
PG16	H10B-SF-1L-CV-PG16
2PG16	H10B-SF-1L-CV-2PG16
---	With metal cover
M20	H10B-SF-1L-MCV-M20
2M20	H10B-SF-1L-MCV-2M20
M25	H10B-SF-1L-MCV-M25
2M25	H10B-SF-1L-MCV-2M25
PG16	H10B-SF-1L-MCV-PG16
2PG16	H10B-SF-1L-MCV-2PG16

With protection covers

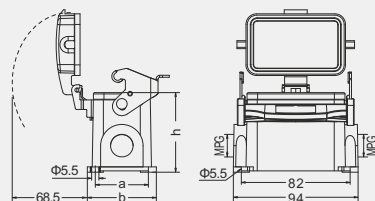

	a	b	h
Low construction	40	52	54
High construction	45	57	74

Degree of protection: IP65

Hoods

Side entry



Thread	Type
M25	H16B-SE-4B-M25
M32	H16B-SE-4B-M32
PG21	H16B-SE-4B-PG21

Low construction

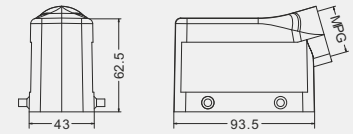

Side entry



Thread	Type
M32	H16B-SEH-4B-M32
M40	H16B-SEH-4B-M40
PG21	H16B-SEH-4B-PG21
PG29	H16B-SEH-4B-PG29

High construction

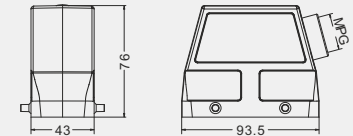

Top entry



Thread	Type
M25	H16B-TE-4B-M25
M32	H16B-TE-4B-M32
PG21	H16B-TE-4B-PG21

Low construction

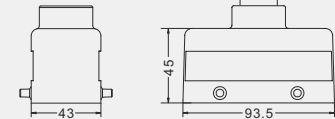

Top entry



Thread	Type
M32	H16B-TEH-4B-M32
M40	H16B-TEH-4B-M40
PG21	H16B-TEH-4B-PG21
PG29	H16B-TEH-4B-PG29

High construction

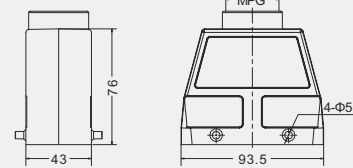

Housings

Housings, bulkhead mounting



Thread	Type
---	H16B-BK-2L

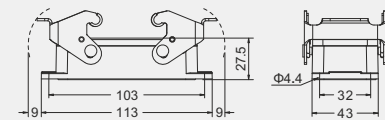

Housings, surface mounting



Thread	Type
M25	H16B-SF-2L-M25
2M25	H16B-SF-2L-2M25
PG21	H16B-SF-2L-PG21
2PG21	H16B-SF-2L-2PG21

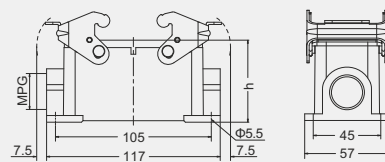

	h
Low construction	56
High construction	81

Housings Cable to cable



Thread	Type
M25	HV16B-CCT-1L-M25
M32	HV16B-CCT-1L-M32
PG21	HV16B-CCT-1L-PG21

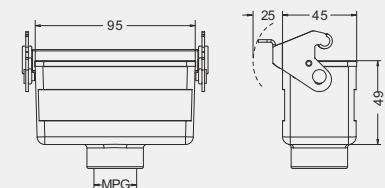

Degree of protection: IP65

Housings

Housings Cable to cable



Thread	Type
M32	HV16B-CCTH-1L-M32
M40	HV16B-CCTH-1L-M40
PG21	HV16B-CCTH-1L-PG21
PG29	HV16B-CCTH-1L-PG29

High construction

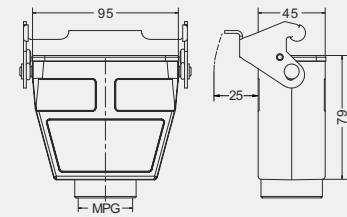

Hoods

Side entry housing with two levers



Thread	Type
M25	H16B-SE-2L-M25
M32	H16B-SE-2L-M32
PG21	H16B-SE-2L-PG21

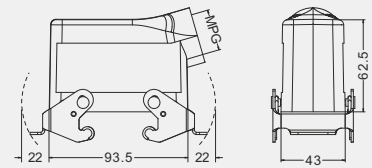

Top entry housing with two levers



Thread	Type
M25	H16B-TE-2L-M25
M32	H16B-TE-2L-M32
PG21	H16B-TE-2L-PG21

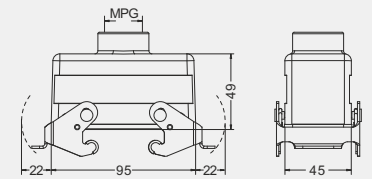

Housings

Bulkhead mounted with 4 bolts



Thread	Type
---	H16B-BK-4B
---	With plastic cover H16B-BK-4B-CV
---	With metal cover H16B-BK-4B-MCV

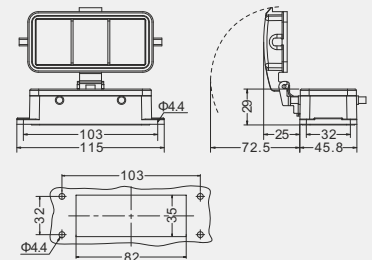

Surface mounting with 4 bolts



Thread	Type
M25	H16B-SF-4B-M25
2M25	H16B-SF-4B-2M25
PG21	H16B-SF-4B-PG21
2PG21	H16B-SF-4B-2PG21
---	With plastic cover
M25	H16B-SF-4B-CV-M25
2M25	H16B-SF-4B-CV-2M25
PG21	H16B-SF-4B-CV-PG21
2PG21	H16B-SF-4B-CV-2PG21
---	With metal cover
M25	H16B-SF-4B-MCV-M25
2M25	H16B-SF-4B-MCV-2M25
PG21	H16B-SF-4B-MCV-PG21
2PG21	H16B-SF-4B-MCV-2PG21

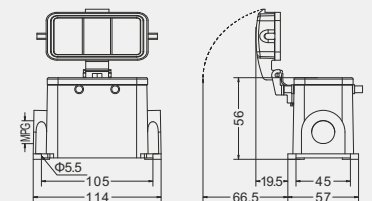

Degree of protection: IP65

Hoods

Side entry



Thread	Type
M25	H16B-SE-2B-M25
M32	H16B-SE-2B-M32
PG21	H16B-SE-2B-PG21

Low construction

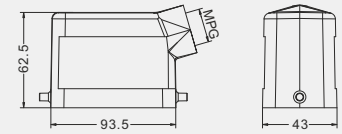

Side entry



Thread	Type
M32	H16B-SEH-2B-M32
M40	H16B-SEH-2B-M40
PG21	H16B-SEH-2B-PG21
PG29	H16B-SEH-2B-PG29

High construction

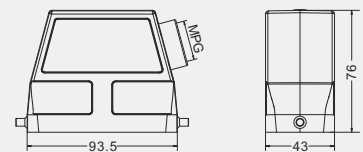

Top entry



Thread	Type
M25	H16B-TE-2B-M25
M32	H16B-TE-2B-M32
PG21	H16B-TE-2B-PG21

Low construction

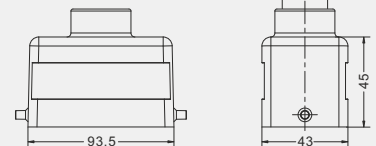

Top entry



Thread	Type
M32	H16B-TEH-2B-M32
M40	H16B-TEH-2B-M40
PG21	H16B-TEH-2B-PG21
PG29	H16B-TEH-2B-PG29

High construction

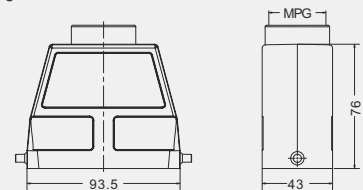

Housings

Housings, bulkhead mounting



Thread	Type
---	H16B-BK-1L
---	With plastic cover
---	H16B-BK-1L-CV
---	With metal cover
---	H16B-BK-1L-MCV

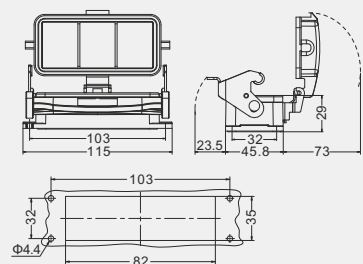

Housings, surface mounting



Thread	Type
M25	H16B-SF-1L-M25
2M25	H16B-SF-1L-2M25
PG21	H16B-SF-1L-PG21
2PG21	H16B-SF-1L-2PG21
---	With plastic cover
M25	H16B-SF-1L-CV-M25
2M25	H16B-SF-1L-CV-2M25
PG21	H16B-SF-1L-CV-PG21
2PG21	H16B-SF-1L-CV-2PG21
---	With metal cover
M25	H16B-SF-1L-MCV-M25
2M25	H16B-SF-1L-MCV-2M25
PG21	H16B-SF-1L-MCV-PG21
2PG21	H16B-SF-1L-MCV-2PG21

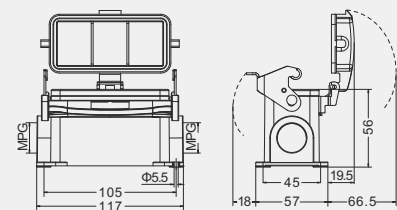

Degree of protection: IP65

Hoods

Side entry



Thread	Type
M25	H24B-SE-4B-M25
M32	H24B-SE-4B-M32
PG21	H24B-SE-4B-PG21

Low construction

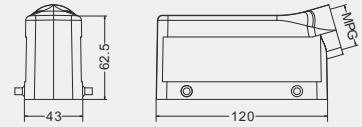

Side entry



Thread	Type
M32	H24B-SEH-4B-M32
M40	H24B-SEH-4B-M40
PG21	H24B-SEH-4B-PG21
PG29	H24B-SEH-4B-PG29

High construction

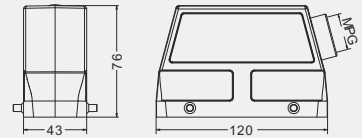

Top entry



Thread	Type
M25	H24B-TE-4B-M25
M32	H24B-TE-4B-M32
PG21	H24B-TE-4B-PG21

Low construction

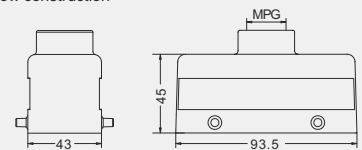

Top entry



Thread	Type
M32	H24B-TEH-4B-M32
M40	H24B-TEH-4B-M40
PG21	H24B-TEH-4B-PG21
PG29	H24B-TEH-4B-PG29

High construction

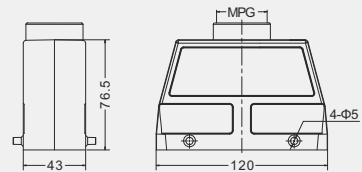

Housings

Bulkhead mounting



Thread	Type
---	H24B-BK-2L

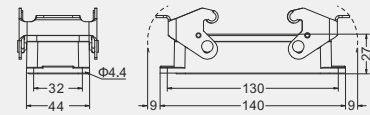

Surface mounting



Thread	Type
M25	H24B-SF-2L-M25
2M25	H24B-SF-2L-2M25
PG21	H24B-SF-2L-PG21
2PG21	H24B-SF-2L-2PG21

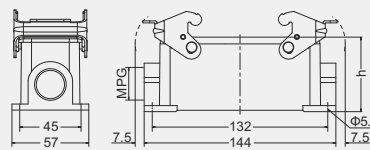

	h
Low construction	56
High construction	81

Housings Cable to cable



Thread	Type
M25	H24B-CCT-1L-M25
M32	H24B-CCT-1L-M32
PG21	H24B-CCT-1L-PG21
PG29	H24B-CCT-1L-PG29

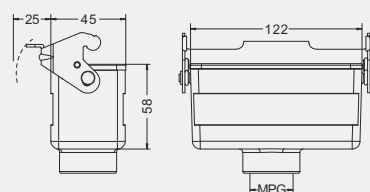

Degree of protection: IP65

Housings

Housings Cable to cable



Thread	Type
M32	H24B-CCTH-1L-M32
M40	H24B-CCTH-1L-M40
PG21	H24B-CCTH-1L-PG21
PG29	H24B-CCTH-1L-PG29

High construction

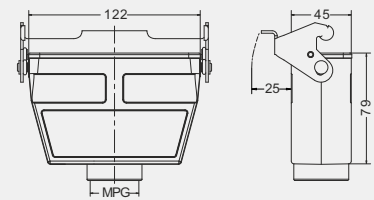

Hoods

Side entry housing with two levers



Thread	Type
M25	H24B-SE-2L-M25
M32	H24B-SE-2L-M32
PG21	H24B-SE-2L-PG21

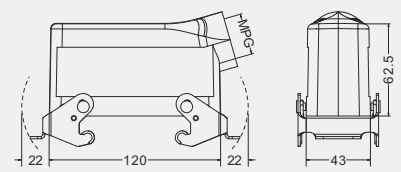

Top entry housing with two levers



Thread	Type
M25	H24B-TE-2L-M25
M32	H24B-TE-2L-M32
PG21	H24B-TE-2L-PG21
PG29	H24B-TE-2L-PG29

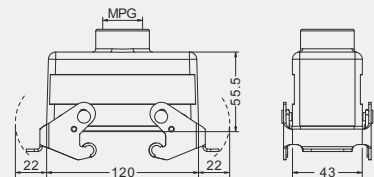

Housings

Bulkhead mounted with 4 bolts



Thread	Type
---	H24B-BK-4B
---	H24B-BK-4B-CV
---	H24B-BK-4B-MCV

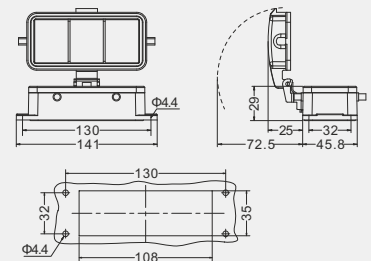

Surface mounting with 4 bolts



Thread	Type
M25	H24B-SF-4B-M25
2M25	H24B-SF-4B-2M25
PG21	H24B-SF-4B-PG21
2PG21	H24B-SF-4B-2PG21
---	H24B-SF-4B-CV-M25
---	H24B-SF-4B-CV-2M25
---	H24B-SF-4B-CV-PG21
---	H24B-SF-4B-CV-2PG21
---	H24B-SF-4B-MCV-M25
---	H24B-SF-4B-MCV-2M25
---	H24B-SF-4B-MCV-PG21
---	H24B-SF-4B-MCV-2PG21

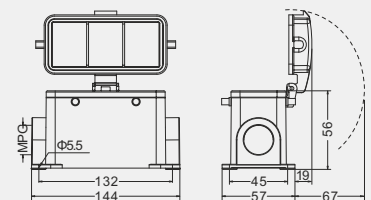

Degree of protection: IP65

Hoods

Side entry



Thread	Type
M25	H24B-SE-2B-M25
M32	H24B-SE-2B-M32
PG21	H24B-SE-2B-PG21

Low construction

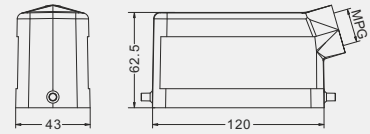

Side entry



Thread	Type
M32	H24B-SEH-2B-M32
M40	H24B-SEH-2B-M40
PG21	H24B-SEH-2B-PG21
PG29	H24B-SEH-2B-PG29
PG36	H24B-SEH-2B-PG36

High construction

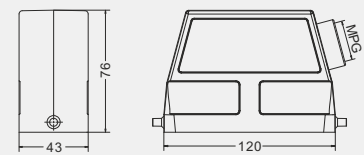

Top entry



Thread	Type
M25	H24B-TE-2B-M25
M32	H24B-TE-2B-M32
PG21	H24B-TE-2B-PG21
PG29	H24B-TE-2B-PG29

Low construction

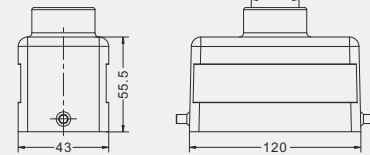

Top entry



Thread	Type
M32	H24B-TEH-2B-M32
M40	H24B-TEH-2B-M40
PG21	H24B-TEH-2B-PG21
PG29	H24B-TEH-2B-PG29
PG36	H24B-TEH-2B-PG36

High construction

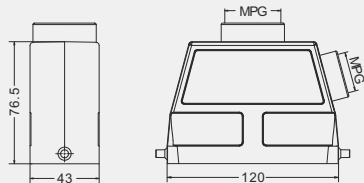

Housings

Housings, bulkhead mounting



Thread	Type
---	H24B-BK-1L
---	With plastic cover H24B-BK-1L-CV
---	With metal cover H24B-BK-1L-MCV

With protection covers

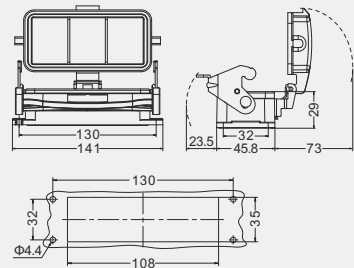

Housings, surface mounting



Thread	Type
M25	H24B-SF-1L-M25
2M25	H24B-SF-1L-2M25
PG21	H24B-SF-1L-PG21
2PG21	H24B-SF-1L-2PG21
---	With plastic cover
M25	H24B-SF-1L-CV-M25
2M25	H24B-SF-1L-CV-2M25
PG21	H24B-SF-1L-CV-PG21
2PG21	H24B-SF-1L-CV-2PG21
---	With metal cover
M25	H24B-SF-1L-MCV-M25
2M25	H24B-SF-1L-MCV-2M25
PG21	H24B-SF-1L-MCV-PG21
2PG21	H24B-SF-1L-MCV-2PG21

With protection covers

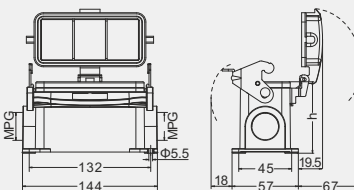

	h
Low construction	56
High construction	81

Degree of protection: IP65

Hoods

Side entry



Thread	Type
M32	H32B-SE-4B-M32
M40	H32B-SE-4B-M40
M50	H32B-SE-4B-M50
PG29	H32B-SE-4B-PG29
PG36	H32B-SE-4B-PG36
PG42	H32B-SE-4B-PG42

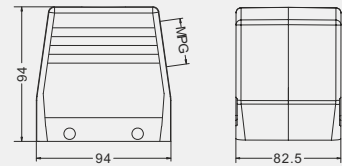

Top entry



Thread	Type
M32	H32B-TE-4B-M32
M40	H32B-TE-4B-M40
M50	H32B-TE-4B-M50
PG29	H32B-TE-4B-PG29
PG36	H32B-TE-4B-PG36
PG42	H32B-TE-4B-PG42

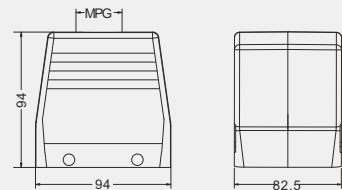

Housings

Housings, bulkhead mounting



Thread	Type
---	H32B-BK-2L

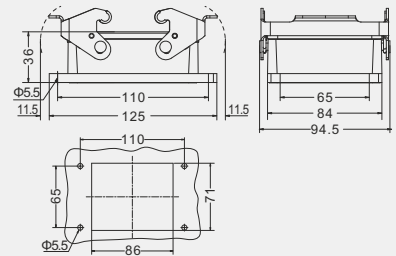

Housings, surface mounting



Thread	Type
M32	H32B-SF-2L-M25
2M32	H32B-SF-2L-2M25
M40	H32B-SF-2L-M40
2M40	H32B-SF-2L-2M40
PG29	H32B-SF-2L-PG29
2PG29	H32B-SF-2L-2PG29
PG36	H32B-SF-2L-PG36
2PG36	H32B-SF-2L-2PG36
3PG42	H32B-SF-2L-2PG42

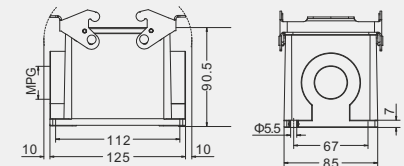

Top entry



Thread	Type
M32	H32B-CCT-2L-M32
M40	H32B-CCT-2L-M40
PG29	H32B-CCT-2L-PG29
PG36	H32B-CCT-2L-PG36
PG42	H32B-CCT-2L-PG42

High construction

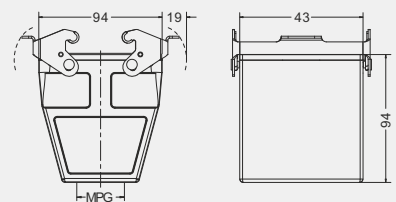

Housings Cable to cable



Thread	Type
---	H32B-MCV-4B/2

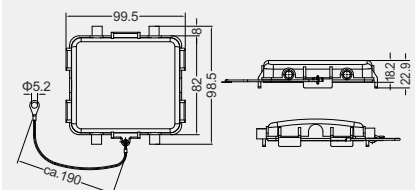

Degree of protection: IP65

Hoods

Side entry



Thread	Type
M32	HV32B-SE-2B-M32
PG29	HV32B-SE-2B-PG29
PG36	HV32B-SE-2B-PG36
PG42	HV32B-SE-2B-PG42

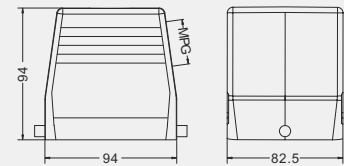

Top entry



Thread	Type
M32	H32B-TE-2B-M32
M40	H32B-TE-2B-M40
M50	H32B-TE-2B-M50
PG29	H32B-TE-2B-PG29
PG36	H32B-TE-2B-PG36
PG42	H32B-TE-2B-PG42

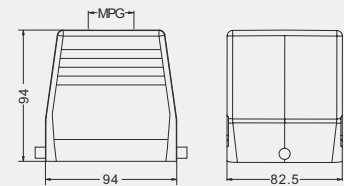

Housings

Bulkhead mounting



Thread	Type
---	HV32B-BK-1L
---	With plastic cover HV32B-BK-1L-CV
---	With metal cover HV32B-BK-1L-MCV

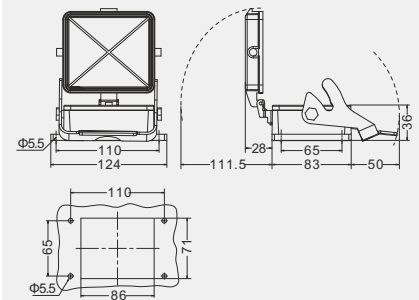

Surface mounting



Thread	Type
M32	HV32B-SF-1L-M32
2M32	HV32B-SF-1L-2M32
M40	HV32B-SF-1L-M40
2M40	HV32B-SF-1L-2M40
PG29	HV32B-SF-1L-PG29
2PG29	HV32B-SF-1L-2PG29
PG36	HV32B-SF-1L-PG36
2PG36	HV32B-SF-1L-2PG36
---	With plastic cover
M32	HV32B-SF-1L-CV-M32
2M32	HV32B-SF-1L-CV-2M32
M40	HV32B-SF-1L-CV-M40
2M40	HV32B-SF-1L-CV-2M40
PG29	HV32B-SF-1L-CV-PG29
2PG29	HV32B-SF-1L-CV-2PG29
PG36	HV32B-SF-1L-CV-PG36
2PG36	HV32B-SF-1L-CV-2PG36
---	With metal cover
M32	HV32B-SF-1L-MCV-M32
2M32	HV32B-SF-1L-MCV-2M32
M40	HV32B-SF-1L-MCV-M40
2M40	HV32B-SF-1L-MCV-2M40
PG29	HV32B-SF-1L-MCV-PG29
2PG29	HV32B-SF-1L-MCV-2PG29
PG36	HV32B-SF-1L-MCV-PG36
2PG36	HV32B-SF-1L-MCV-2PG36

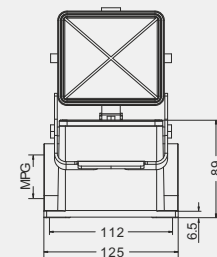
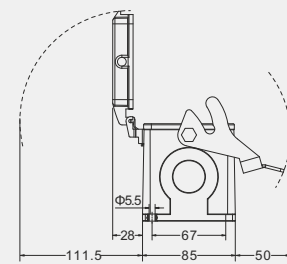

Degree of protection: IP65

Hoods

Side entry



Thread	Type
M32	H48B-SE-2B-M32
M40	H48B-SE-2B-M40
M50	H48B-SE-2B-M50
PG29	H48B-SE-2B-PG29
PG36	H48B-SE-2B-PG36
PG42	H48B-SE-2B-PG42

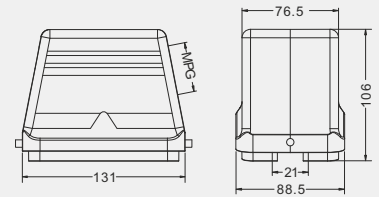

Top entry



Thread	Type
M32	H48B-TE-2B-M32
M40	H48B-TE-2B-M40
M50	H48B-TE-2B-M50
PG29	H48B-TE-2B-PG29
PG36	H48B-TE-2B-PG36
PG42	H48B-TE-2B-PG42

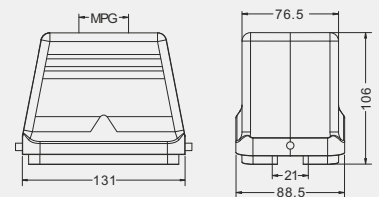

Housings

Bulkhead mounting



Thread	Type
---	H48B-BK-1L
---	With plastic cover
---	H48B-BK-1L-CV
---	With metal cover
---	H48B-BK-1L-MCV

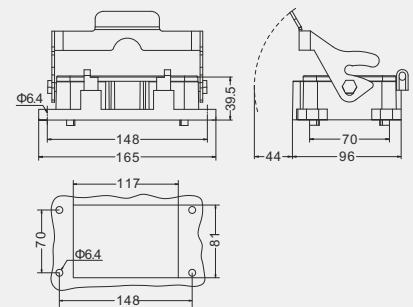

Surface mounting



Thread	Type
M32	H48B-SF-1L-M32
2M32	H48B-SF-1L-2M32
M40	H48B-SF-1L-M40
2M40	H48B-SF-1L-2M40
PG29	H48B-SF-1L-PG29
2PG29	H48B-SF-1L-2PG29
PG36	H48B-SF-1L-PG36
2PG36	H48B-SF-1L-2PG36
---	With plastic cover
M32	H48B-SF-1L-CV-M32
2M32	H48B-SF-1L-CV-2M32
M40	H48B-SF-1L-CV-M40
2M40	H48B-SF-1L-CV-2M40
PG29	H48B-SF-1L-CV-PG29
2PG29	H48B-SF-1L-CV-2PG29
PG36	H48B-SF-1L-CV-PG36
2PG36	H48B-SF-1L-CV-2PG36
---	With metal cover
M32	H48B-SF-1L-MCV-M32
2M32	H48B-SF-1L-MCV-2M32
M40	H48B-SF-1L-MCV-M40
2M40	H48B-SF-1L-MCV-2M40
PG29	H48B-SF-1L-MCV-PG29
2PG29	H48B-SF-1L-MCV-2PG29
PG36	H48B-SF-1L-MCV-PG36
2PG36	H48B-SF-1L-MCV-2PG36

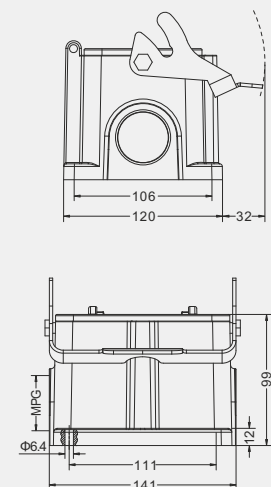

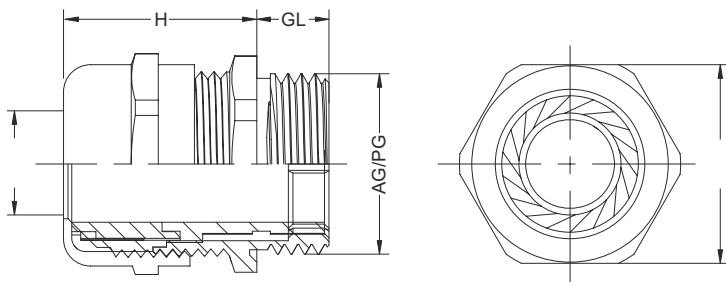

Materials : Nylon plastic

Seals : Nitrile rubber (NBR)

Protection level : IP67-5 Bar pressure

(Tighten the part and use O-seal)

Ambient temperature : Static -40 °C to 100 °C, short time to 120 °C

Dynamic -20 °C to 80 °C, short time to 100 °C

Supply color : gray

black

Please ask for other colors

AG PG	∅k mm	GL mm	H mm	⌀ mm
7	3-6.5	8	22	16
7	2-5	8	22	16
9	4-8	8	26	19
9	2-6	8	26	19
11	5-10	8	27	22
11	3-7	8	27	22
13.5	6-12	9	28	24
13.5	5-9	9	28	24
16	10-14	10	30	27
16	7-12	10	30	27
19	12-15	10	30	27/28
19	10-12	10	30	27/28
21	13-18	11	35	33
21	9-16	11	35	33

AG PG	∅k mm	GL mm	H mm	⌀ mm
25	16-21	11	34	35/36
25	13-18	11	34	35/36
29	18-25	12	40	41/42
29	13-20	12	40	41/42
36	22-32	14	48	52/53
36	20-26	14	48	52/53
42	32-38	15	49	60/61
42	25-31	15	49	60/61
48	37-44	15	50	64/65
48	29-35	15	50	64/65
63	42-50	27	60	72

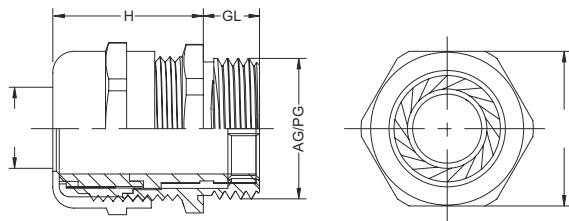
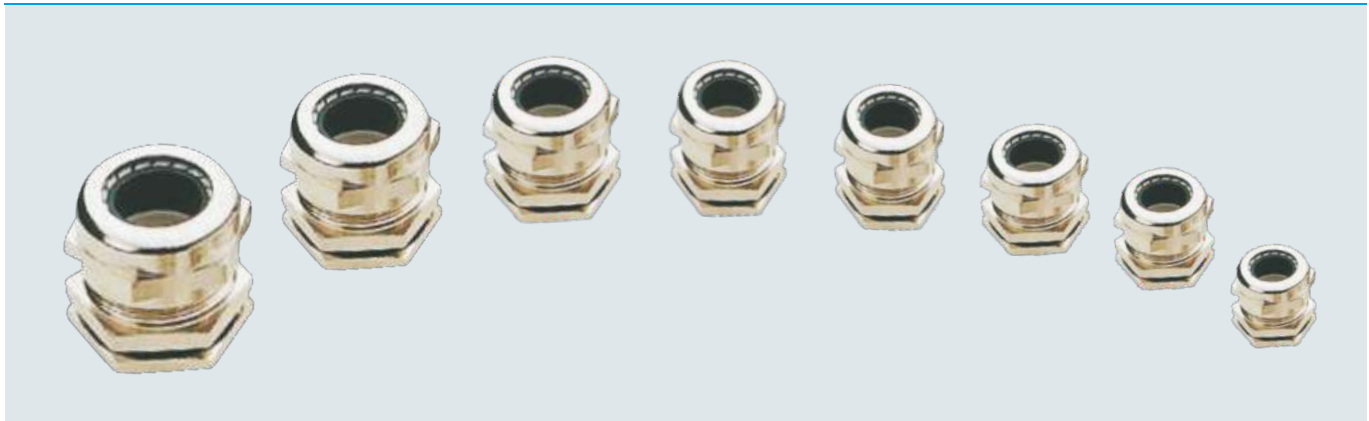

AG PG	∅ mm	GL mm	GL(加长) mm	H mm	∅ mm
7	3-6.5	5	10	19	14
7	2-5	5	10	19	14
9	4-8	6	10	20	17
9	2-6	6	10	20	17
11	5-10	6	10	21	20
11	3-7	6	10	21	20
13.5	6-12	6.5	10	22	22
13.5	5-9	6.5	10	22	22
16	10-14	6.5	10	23	24
16	7-12	6.5	10	23	24

Materials : Nylon plastic
 Seals : Nitrile rubber (NBR)
 Protection level : IP67-5 bar pressure
 (Tighten the part and use O-seal)
 Ambient temperature : Static -40 °C to 100 °C, short time to 120 °C
 Dynamic -20 °C to 80 °C, short time to 100 °C
 Supply color : Gray, black, other colors please ask

AG PG	∅ mm	GL mm	GL(加长) mm	H mm	∅ mm
21	13-18	7	12	25	30
21	9-16	7	12	25	30
29	18-25	8	12	29	40
29	13-20	8	12	29	40
36	22-32	8	15	35	50
36	20-26	8	15	35	50
42	32-38	9	15	37	57
42	25-31	9	15	37	57
48	37-44	10	15	38	64
48	29-35	10	15	38	64

Quick Screw Connector



Product Material : PA nylon;
 Thread specification : Metric thread, German thread;
 Operating temperature : -40°C~+110°C ;
 colour : Black and other colors can be customized;
 Product Features : Special design of inner lock and body, only need to pull and insert without tools when loading and unloading
 Method of action : The hose connector is a matching product of the hose, which can be connected to the equipment box or can be connected to the electric equipment with the internal thread in and out, and only need to be inserted into the interface.

PG Thread

Thread Size	Fits to tubing size (mm)	GL (mm)	H (mm)
PG7	AD10	8.5	22.5
PG9	AD13	8.5	23
PG11	AD15.8	10	25
PG13.5	18.5	12	25
PG16	21.2	12	28
PG21	28.5	12	31
PG29	34.5	12	33
PG36	42.5	13.5	35.5
PG48	54.5	15	39

Metric Thread

Thread Size	Fits to tubing size (mm)	GL (mm)	H (mm)
M12×1.5	10	8.5	22.5
M16×1.5	13	8.8	23
M18×1.5	15.8	10	25
M20×1.5	18.5	12	25
M22×1.5	21.2	12	28
M24×1.5	28.5	12	31
M32×1.5	34.5	12	33
M40×1.5	42.5	13.5	35.5
M63×1.5	54.5	15	39

SUPAFLEX

www.supaflex.co.in

Contact Us

SUPA FLEX PVT. LTD.

Address

Plot No. 8/33, III Floor, R.H.S. Complex,
Industrial Area Kirti Nagar, New Delhi 110015
INDIA

Telephone

+91-11-68888708

Mobile

+91-95999992308 | +91-9599992306-10

E-mail

sales@supaflex.co.in | sales1@supaflex.co.in



Follow us on



Ha Series

3Pole Connector

Technical Data:
Rated Current: 10A
Rated Voltage: 230/250V
Flammability acc to UL94: V0
Protection Degree acc to DIN 40 050: IP65
Terminal Connection: Screw Terminal
Thread: M20, PG11

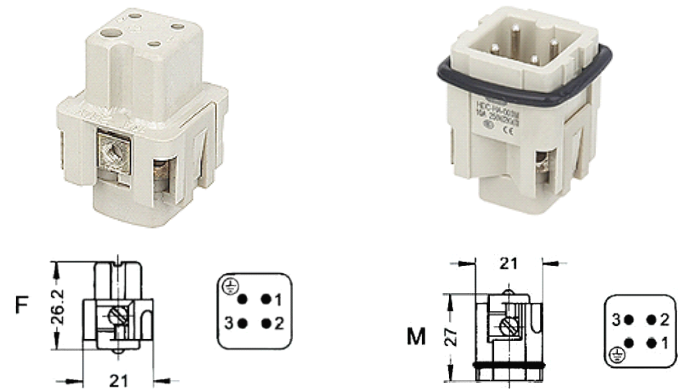

Shells:

H3A-MTG	H3A-MTG	H3A-MTG	H3A-MTS	H3A-MTS
H3A-MAG	H3A-MTGVB	H3A-MAGSV	H3A-MAG	H3A-MAGSV

Order NO.: (Complete Sets)

HA-003-2	HA-003-5	HA-003-4	HA-003-1	HA-003-6
----------	----------	----------	----------	----------

Drawings:

H3A-MTG	H3A-MTS	H3A-MAG	H3A-MTGVB	H3A-MAGSV

Note - Above models also available with cover . Part No with DB

Ha Series

4Pole Connector

Technical Data:
Rated Current: 10A
Rated Voltage: 230/250V
Flammability acc to UL94: V0
Protection Degree acc to DIN 40 050: IP65
Terminal Connection: Screw Terminal
Thread: M20, PG11

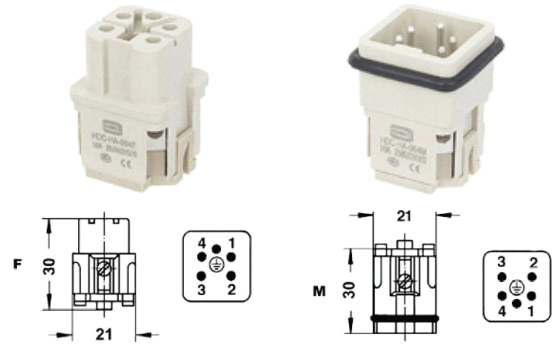

Shells:

H3A-MTG	H3A-MTG	H3A-MTG	H3A-MTS	H3A-MTS
H3A-MAG	H3A-MTGVB	H3A-MAGSV	H3A-MAG	H3A-MAGSV

Order NO.: (Complete Sets)

HA-004-2	HA-004-5	HA-004-4	HA-004-1	HA-004-6
----------	----------	----------	----------	----------

Drawings:

H3A-MTG	H3A-MTS	H3A-MAG	H3A-MTGVB	H3A-MAGSV

Note - Above models also available with cover . Part No with DB