

NOVEMBER
2022
PRICE LIST



jainson
SINCE 1971



- | P.G CABLE GLANDS
- | H.R.C FUSE FITTING
- | POLYAMIDE FLEXIBLE
CONDUIT PIPE & GLANDS
- | A.B.S JUNCTION BOX IP-65
- | JUNCTION BOX WITH
CONNECTORS IP-65
- | LED INDICATOR



WHITE CABLE GLANDS

HSN CODE - 39174000



JPG-7
PG Thread Cable Glands

		PRICE
Catalogue No.	JPG-7	4.30
Std. Packing	100	
Master Packing :	7000	



JPG-9
PG Thread Cable Glands

		PRICE
Catalogue No.	JPG-7	5.30
Std. Packing	100	
Master Packing :	5000	



JPG-11
PG Thread Cable Glands

		PRICE
Catalogue No.	JPG-7	6.80
Std. Packing	100	
Master Packing :	3500	



JPG-13.5
PG Thread Cable Glands

		PRICE
Catalogue No.	JPG-7	7.35
Std. Packing	100	
Master Packing :	3500	



JPG-16
PG Thread Cable Glands

		PRICE
Catalogue No.	JPG-7	9.00
Std. Packing	100	
Master Packing :	2500	



JPG-19
PG Thread Cable Glands

		PRICE
Catalogue No.	JPG-7	12.60
Std. Packing	100	
Master Packing :	2000	



JPG-21
PG Thread Cable Glands

		PRICE
Catalogue No.	JPG-7	13.90
Std. Packing	100	
Master Packing :	1400	



JPG-25
PG Thread Cable Glands

		PRICE
Catalogue No.	JPG-7	16.50
Std. Packing	100	
Master Packing :	1200	



JPG-29
PG Thread Cable Glands

		PRICE
Catalogue No.	JPG-7	24.00
Std. Packing	50	
Master Packing :	800	



JPG-36
PG Thread Cable Glands

		PRICE
Catalogue No.	JPG-7	44.00
Std. Packing	25	
Master Packing :	450	



JPG-42
PG Thread Cable Glands

		PRICE
Catalogue No.	JPG-7	58.00
Std. Packing	25	
Master Packing :	300	



JPG-48
PG Thread Cable Glands

		PRICE
Catalogue No.	JPG-7	64.00
Std. Packing	20	
Master Packing :	280	



JPG-63
PG Thread Cable Glands

		PRICE
Catalogue No.	JPG-7	120.00
Std. Packing	12	
Master Packing :	120	

BLACK CABLE GLANDS

HSN CODE - 39174000



JPG-7
PG Thread Cable Glands

		PRICE
Catalogue No.	JPG-7	4.30
Std. Packing	100	
Master Packing :	2500	



JPG-9
PG Thread Cable Glands

		PRICE
Catalogue No.	JPG-9	5.30
Std. Packing	100	
Master Packing :	2500	



JPG-11
PG Thread Cable Glands

		PRICE
Catalogue No.	JPG-11	6.80
Std. Packing	100	
Master Packing :	3500	



JPG-13.5
PG Thread Cable Glands

		PRICE
Catalogue No.	JPG-13.5	7.35
Std. Packing	100	
Master Packing :	1500	



JPG-16
PG Thread Cable Glands

		PRICE
Catalogue No.	JPG-16	9.00
Std. Packing	100	
Master Packing :	2500	



JPG-19
PG Thread Cable Glands

		PRICE
Catalogue No.	JPG-19	12.60
Std. Packing	100	
Master Packing :	2000	

METRIC THREADED CABLE GLANDS

HSN CODE - 39174000



JPGM-12
Metric Thread Cable Glands

		PRICE
Catalogue No.	JPGM-12mmX1.5	5.50
Std. Packing	100	
Master Packing :	2500	



JPGM-16
Metric Thread Cable Glands

		PRICE
Catalogue No.	JPGM-16mmX1.5	6.50
Std. Packing	100	
Master Packing :	2500	



JPGM-20
Metric Thread Cable Glands

		PRICE
Catalogue No.	JPGM-20mmX1.5	8.00
Std. Packing	100	
Master Packing :	2500	



JPGM-25
Metric Thread Cable Glands

		PRICE
Catalogue No.	JPGM-25mmX1.5	16.00
Std. Packing	100	
Master Packing :	2500	



JPGM-32
Metric Thread Cable Glands

		PRICE
Catalogue No.	JPGM-32mmX1.5	25.00
Std. Packing	100	
Master Packing :	2500	



JPG-7-12mm
PG Thread Cable Glands

		PRICE
Catalogue No.	JPG-7-12mm	6.25
Std. Packing	100	
Master Packing :	2500	



JPG-7-15mm
PG Thread Cable Glands

		PRICE
Catalogue No.	JPG-7-15mm	7.25
Std. Packing	100	
Master Packing :	2500	



JPG-9-12mm
PG Thread Cable Glands

		PRICE
Catalogue No.	JPG-9-12mm	9.00
Std. Packing	100	
Master Packing :	2500	



JPG-9-15mm
PG Thread Cable Glands

		PRICE
Catalogue No.	JPG-9-15mm	10.00
Std. Packing	100	
Master Packing :	2500	

CABLE GLANDS HSN CODE - 39174000

WATER PROOF JUNCTION BOX - ABS WITHOUT GOURMET **HSN CODE - 85359040**



JJB-100

Dimension :
100mm x 100mm x 70mm

		PRICE
Catalogue No.	JJB-100	83.00
Master Packing :	180	



JJB-150110

Dimension :
150mm x 110mm x 70mm

		PRICE
Catalogue No.	JJB-150110	142.00
Master Packing :	110	



JJB-150

Dimension :
150mm x 150mm x 70mm

		PRICE
Catalogue No.	JJB-150	165.00
Master Packing :	80	



JJB-200

Dimension :
200mm x 155mm x 80mm

		PRICE
Catalogue No.	JJB-200	220.00
Master Packing :	56	



JJB-255

Dimension :
255mm x 200mm x 80mm

		PRICE
Catalogue No.	JJB-255	320.00
Master Packing :	36	



JJB-300

Dimension :
300mm x 250mm x 120mm

		PRICE
Catalogue No.	JJB-300	600.00
Master Packing :	20	



JJB-400

Dimension :
400mm x 350mm x 120mm

		PRICE
Catalogue No.	JJB-400	1400.00
Master Packing :	10	

CAMERA BOX **HSN CODE - 85359040**



JCB-01

Dimension :
100mm x 100mm x 70mm

		PRICE
Catalogue No.	JCB-01	59.00
Master Packing :	180	

JUNCTION BOX WITHOUT CONNECTOR IP-65

HSN CODE - 85359040



JJB-9020

Dimension :
88mm x 88mm x 53mm

		PRICE
Catalogue No.	JJB-9020	145.00
Master Packing :	175	---



JJB-9040

Dimension :
98mm x 98mm x 61mm

		PRICE
Catalogue No.	JJB-9040	160.00
Master Packing :	150	---



JJB-9060

Dimension :
139mm x 119mm x 70mm

		PRICE
Catalogue No.	JJB-9060	250.00
Master Packing :	100	---



JJB-9100

Dimension :
167mm x 125mm x 82mm

		PRICE
Catalogue No.	JJB-9100	370.00
Master Packing :	50	---

JUNCTION BOX WITH CONNECTOR IP-65 (WITH BRASS CONTACT)

HSN CODE - 85359040



JJB-9020J

Dimension :
88mm x 88mm x 53mm
Size : 2.5 sq. mm

		PRICE
Catalogue No.	JJB-9020J	185.00
Master Packing :	175	---



JJB-9040J

Dimension :
98mm x 98mm x 61mm
Size : 4-6 sq. mm

		PRICE
Catalogue No.	JJB-9040J	205.00
Master Packing :	150	---



JJB-9060J

Dimension :
139mm x 119mm x 70mm
Size : 10 sq. mm

		PRICE
Catalogue No.	JJB-9060J	325.00
Master Packing :	100	---



JJB-9100J

Dimension :
167mm x 125mm x 82mm
Size : 16 sq. mm

		PRICE
Catalogue No.	JJB-9100J	620.00
Master Packing :	50	---

POLY AMID FLEXIBLE CONDUCT GLAND

HSN CODE - 39174000

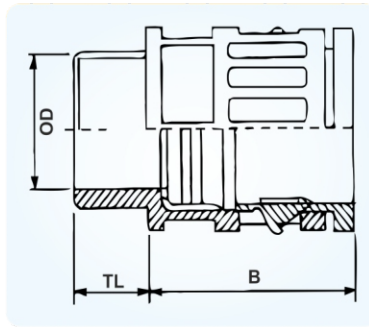

Technical Details :

Material	Polyamide PA - 6 - V - 2
Temperature Range	-40°C to +105°C Short Term 150°C

CAT NO. BLACK	A D SIZE	THREAD (OD) mm	PIPE (OD) mm	Thread Length mm	(B) mm	PRICE LIST	STD. PKG
JCG - 7	10	12.3	6.5	11	18.7	14.50	100
JCG - 9	13	15	10	11	21.7	15.00	100
JCG - 11	15.8	18.4	12.5	11	26	17.00	100
JCG - 13.5	18.4	20.2	14.3	11	28	20.00	100
JCG - 16	21.2	22.3	17.0	13	32	25.00	100
JCG - 21	28.5	28	23	16	39.5	35.00	50
JCG - 29	34.5	36.7	29	16	46.5	50.00	25
JCG - 36	42.5	46.7	36	16	55.5	65.00	25

POLYAMID FLEXIBLE CONDUCT PIPE

HSN CODE - 39173100

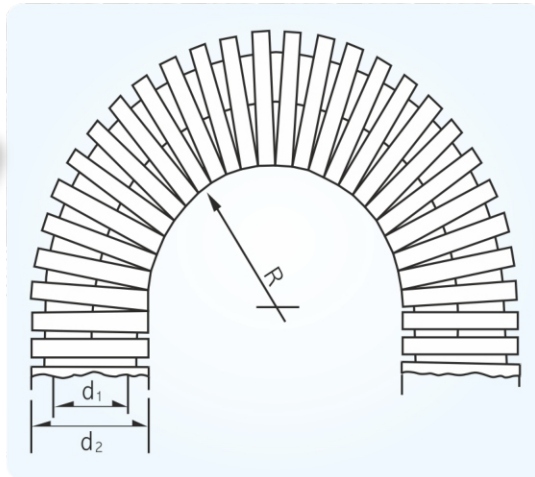

Technical Details :

Material	Polyamide PA - 6 - V - 2
Tensile Strength	750 N
Impact Strength	(+23°C) > 20 J (-15°C) > 6 J
Temperature Range	-40°C to +120°C Continuous, Short Term 150°C

CAT NO. BLACK	A D SIZE	INNER DIAMETER d1 (mm)	OUTER DIAMETER d2 (mm)	BENDING RADIUS R (mm) ± 10%	PRICE/MTR	PACKING/MTR	ROLL/STD PACK
JCP - 7	10	6.5	10.0	20	22.00	100	16
JCP - 9	13	10	13.0	30	24.00	100	10
JCP - 11	15.8	12	15.8	40	33.00	50	10
JCP - 13.5	18.4	14.3	18.5	42	38.00	50	10
JCP - 16	21.2	16.5	21.2	45	45.00	50	10
JCP - 21	28.5	23.5	28.5	55	70.00	50	8
JCP - 29	34.5	29	34.5	60	90.00	25	6
JCP - 36	42.5	36	42.5	65	135.00	25	6

H.R.C. FUSE FITTING (FRONT CONNECTION)

HSN CODE - 85361020

JFC-20A



20 Amp - 415 V

		PRICE
Catalogue No.	JFC-20A	86.00
Standard Packing :	10	
Master Packing :	400	

JFC-32A



32 Amp - 500 V

		PRICE
Catalogue No.	JFC-32A	190.00
Standard Packing :	10	
Master Packing :	144	

JFC-63A



63 Amp - 500 V

		PRICE
Catalogue No.	JFC-63A	280.00
Standard Packing :	5	
Master Packing :	120	

JFC-125A



125 Amp - 500 V

		PRICE
Catalogue No.	JFC-125A	690.00
Standard Packing :	3	
Master Packing :	30	

LED INDICATOR LAMP

HSN CODE - 85361020

22.5mm



Colour :
Red, Green, Yellow,
Blue, White

		PRICE
Catalogue No.	JLI-22.5	46.00
Standard Packing :	10	
Master Packing :	1000	

UNDER DEVELOPMENT



**UNDER DEVELOPMENT
PUSH BUTTON BOX**



jainson

SINCE 1971



PAWAN ENTERPRISE
B/22F, Malad Industrial Estate, Kanchpada, Malad (W),
Mumbai - 400 064. • Customer Care : 02240131878
Email : pawanenterprise@yahoo.in