



Relays (8536)

- AC & DC relays from 3A to 100 Amps from 1 to 4 pole
- DC power relays upto 125 Amps
- Miniature, General purpose, Power & Automotive Relays
- Termination via Solder, PCB mounted, Plug-In and Screw type terminals
- Sliver contacts for enhanced life, **ERDA Tested & complies with JSS standards**

M SERIES - MSP (Equivalent to MY)

MSP	Cat No.	Coil Volts	Min Pack	M.R.P. (₹) Per Unit
 <p>Type MSP (AC/DC) with LED at 240V AC/24V DC Plug in Enclosed Version 2 Pole/3 Pole/4 Pole</p>	MSP 2P 12	12V DC	20	209
	MSP 2P 24	24V DC	20	209
	MSP 2P 48	48V DC	20	236
	MSP 2P 110	110V DC	20	222
	MSP 2P 12A	12V AC	20	233
	MSP 2P 24A	24V AC	20	232
	MSP 2P 110A	110V AC	20	256
	MSP 2P 240A	240V AC	20	242
	MSP 3P 12	12V DC	20	219
	MSP 3P 24	24V DC	20	219
	MSP 3P 110	110V DC	20	235
	MSP 3P 24A	24V AC	20	266
	MSP 3P 110A	110V AC	20	275
	MSP 3P 240A	240V AC	20	287
	MSP 4P 12	12V DC	20	221
	MSP 4P 24	24V DC	20	222
	MSP 4P 48	48V DC	20	241
	MSP 4P 110	110V DC	20	241
	MSP 4P 12A	12V AC	20	281
	MSP 4P 24A	24V AC	20	256
MSP 4P 110A	110V AC	20	274	
MSP 4P 240A	240V AC	20	281	

MSP - Test Button	Cat No.	Coil Volts	Min Pack	M.R.P. (₹) Per Unit
<p>Approvals</p>   <p>2 Pole - 12 Amps/4 Pole - 7 Amps @ 277 V AC/30 V DC with Flag & LED-UL Marked</p>	MSP2P012D12TNE	12V DC	20	249
	MSP2P024D12TNE	24V DC	20	249
	MSP2P110D12TNE	110V DC	20	261
	MSP2P012A12TNE	12V AC	20	271
	MSP2P024A12TNE	24V AC	20	270
	MSP2P110A12TNE	110V AC	20	295
	MSP2P240A12TNE	240V AC	20	282
	MSP4P012D07TNE	12V DC	20	284
	MSP4P024D07TNE	24V DC	20	285
	MSP4P110D07TNE	110V DC	20	304
	MSP4P012A07TNE	12V AC	20	343
	MSP4P024A07TNE	24V AC	20	319
	MSP4P110A07TNE	110V AC	20	338
	MSP4P240A07TNE	240V AC	20	343

M SERIES - MKG



MKG	Cat No.	Coil Volts	Min Pack	M.R.P. (₹) Per Unit
 <p>MKG (AC/DC) with LED indication - 5 Amps Resistive at 240V AC/24 DC Plug in Enclosed Version</p>	MKG 2P 06	6V DC	10	283
	MKG 2P 12	12V DC	10	251
	MKG 2P 18	18V DC	10	299
	MKG 2P 24	24V DC	10	254
	MKG 2P 30	30V DC	10	336
	MKG 2P 48	48V DC	10	272
	MKG 2P 110	110V DC	10	303
	MKG 2P 220	220V DC	10	341
	MKG 3P 12	12V DC	10	317
	MKG 3P 18	18V DC	10	319
	MKG 3P 24	24V DC	10	319
	MKG 3P 30	30V DC	10	392
	MKG 3P 48	48V DC	10	380
	MKG 3P 110	110V DC	10	368
	MKG 3P 220	220V DC	10	495
	MKG 2P 06A	06V AC	10	278
	MKG 2P 12A	12V AC	10	259
	MKG 2P 24A	24V AC	10	252
	MKG 2P 110A	110V AC	10	254
	MKG 2P 240A	240V AC	10	325
MKG 3P 12A	12V AC	10	310	
MKG 3P 24A	24V AC	10	303	
MKG 3P 110A	110V AC	10	309	
MKG 3P 240A	240V AC	10	375	

M SERIES - MKP

MKP	Cat No.	Coil Volts	Min Pack	M.R.P. (₹) Per Unit
 <p>Type MKP (AC/DC) with LED indication - 10 Amps Resistive at 240V AC/24V DC Plug in Enclosed Version</p>	MKP 2P 06	06V DC	10	288
	MKP 2P 12	12V DC	10	284
	MKP 2P 24	24V DC	10	285
	MKP 2P 48	48V DC	10	316
	MKP 2P 110	110V DC	10	317
	MKP 2P 220	220V DC	10	422
	MKP 3P 12	12V DC	10	351
	MKP 3P 24	24V DC	10	351
	MKP 3P 48	48V DC	10	391
	MKP 3P 110	110V DC	10	411
	MKP 3P 220	220V DC	10	560
	MKP 2P 06A	06V AC	10	308
	MKP 2P 12A	12V AC	10	301
	MKP 2P 24A	24V AC	10	301
	MKP 2P 110A	110V AC	10	310
	MKP 2P 240A	240V AC	10	404
	MKP 3P 12A	12V AC	10	396
	MKP 3P 24A	24V AC	10	396
	MKP 3P 110A	110V AC	10	389
	MKP 3P 240A	240V AC	10	447

Relays (8536)

M SERIES - MKP

MKP	Cat No.	Coil Volts	Min Pack	M.R.P. (₹) Per Unit
<p>Approvals</p>   <p>Type MKP (AC/DC) with LED indication -10 Amps Resistive at 277V AC/24 DC Plug in Enclosed Version with Test Button/Mechanical Indicator</p>	MKP2P006D10TNE	06V DC	10	358
	MKP2P012D10TNE	12V DC	10	354
	MKP2P024D10TNE	24V DC	10	355
	MKP2P048D10TNE	48V DC	10	386
	MKP2P110D10TNE	110V DC	10	387
	MKP2P220D10TNE	220V DC	10	492
	MKP3P012D10TNE	12V DC	10	421
	MKP3P024D10TNE	24V DC	10	421
	MKP3P048D10TNE	48V DC	10	461
	MKP3P110D10TNE	110V DC	10	481
	MKP3P220D10TNE	220V DC	10	630
	MKP2P006A10TNE	06V AC	10	378
	MKP2P012A10TNE	12V AC	10	371
	MKP2P024A10TNE	24V AC	10	371
	MKP2P110A10TNE	110V AC	10	380
	MKP2P240A10TNE	240V AC	10	474
	MKP3P012A10TNE	12V AC	10	466
	MKP3P024A10TNE	24V AC	10	466
	MKP3P110A10TNE	110V AC	10	459
	MKP3P240A10TNE	240V AC	10	517

Sockets for MK / MSP Series (8538)

SOCKETS	Cat No.	Coil Volts	Min. Pack	M.R.P. (₹) Per Unit
	MK 08C	8 Pin for 2 C/O & Closed Terminals for "MKG/MKP" Relays	20	70
	MK 11C	11 Pin for 3 C/O & Closed Terminals for "MKG/MKP" Relays	20	100
	MSP 08C	Closed Terminals Socket for MSP - 2 Pole	20	104
	MSP 14C	Closed Terminals Socket for MSP - 4 Pole	20	136
	MSP 14P	PCP Socket for MSP - 4 Pole	50	52

UL Sockets for MK / MSP Series available on request

M SERIES - MIC

MIC	Cat No.	Coil Volts	Min Pack	M.R.P. (₹) Per Unit
 <p>MIC (AC/DC) - 12 Amps Resistive at 240V AC/24V DC/ Enclosed solder/ PCB Version</p>	MIC 2P 12	12V DC	20	229
	MIC 2P 24	24V DC	20	237
	MIC 3P 12	12V DC	20	266
	MIC 3P 24	24V DC	20	272

PCB Series - PCB

	Cat No.	Coil Volts	Min. Pack	M.R.P. (₹) Per Unit
 <p>TYPE PCB (5 AMPS) Enclosed Version for PCB</p>	PCB 2P 12	12V DC	10	229
	PCB 2P 24	24V DC	10	239
	PCB 2P 240A	240V AC	10	450
	PCB 3P 12	12V DC	10	323
	PCB 3P 24	24V DC	10	332
	PCB 3P 240A	240V AC	10	501

M SERIES - MSC

MSC	Cat No.	Coil Volts	Min Pack	M.R.P. (₹) Per Unit
 <p>MSC (AC/DC) - 5 Amps Resistive at 240V AC/24V DC Enclosed Solder Version</p>	MSC 1P 12	12V DC	10	143
	MSC 1P 18	18V DC	10	155
	MSC 1P 24	24V DC	10	147
	MSC 2P 06	06V DC	10	218
	MSC 2P 12	12V DC	10	203
	MSC 2P 18	18V DC	10	216
	MSC 2P 24	24V DC	10	209
	MSC 2P 48	48V DC	10	252
	MSC 3P 06	06V DC	10	284
	MSC 3P 12	12V DC	10	248
	MSC 3P 18	18V DC	10	257
	MSC 3P 24	24V DC	10	251
	MSC 3P 48	48V DC	10	340
	MSC 3P 110	110V DC	10	321
	MSC 2P 240A	240V AC	10	315
	MSC 3P 240A	240V AC	10	347

H SERIES - HSC

HSC	Cat No.	Coil Volts	Min Pack	M.R.P. (₹) Per Unit
 <p>HSC (AC/DC) - 10 Amps Resistive at 240V AC/24V DC Enclosed Solder Version</p>	HSC 1P 12	12V DC	10	201
	HSC 1P 18	18V DC	10	226
	HSC 1P 24	24V DC	10	211
	HSC 2P 12	12V DC	10	274
	HSC 2P 18	18V DC	10	326
	HSC 2P 24	24V DC	10	286
	HSC 3P 12	12V DC	10	344
	HSC 3P 18	18V DC	10	309
	HSC 3P 24	24V DC	10	357
	HSC 2P 240A	240V AC	10	437
HSC 3P 240A	240V AC	10	495	

H SERIES - HSR

HSR	Cat No.	Coil Volts	Min Pack	M.R.P. (₹) Per Unit
 <p>HSR (AC/DC) - 16 Amps Resistive at 240V AC/24V DC/ Enclosed Solder Version</p>	HSR 1P 12	12V DC	10	214
	HSR 1P 18	18V DC	10	236
	HSR 1P 24	24V DC	10	239
	HSR 2P 12	12V DC	10	304
	HSR 2P 18	18V DC	10	340
	HSR 2P 24	24V DC	10	314
	HSR 3P 12	12V DC	10	392
	HSR 3P 18	18V DC	10	457
	HSR 3P 24	24V DC	10	419
	HSR 2P 240A	240V AC	10	545
	HSR 3P 240A	240V AC	10	580

PRC SERIES - Power Relays

PRC	Cat No.	Coil Volts	Min Pack	M.R.P. (₹) Per Unit
 <p>PRC 30 (AC/DC) - 30 Amps Resistive at 240V AC/24V DC/ Enclosed</p>	PRC 30 1P 12	12V DC	4	346
	PRC 30 1P 24	24V DC	4	350
	PRC 30 1P 12NO	12V DC	4	302
	PRC 30 2P 12	12V DC	4	467
	PRC 30 2P 24	24V DC	4	471
	PRC 30 2P 12NO	12V DC	4	428
	PRC 30 3P 12	12V DC	4	619
	PRC 30 3P 24	24V DC	4	623
	PRC 30 3P 12NO	12V DC	4	593
	PRC 30 3P 24 NO	24V DC	4	596
	PRC 30 1P 240A	240V AC	4	379
	PRC 30 2P 240A	240V AC	4	501
	PRC 30 3P 240A	240V AC	4	640
 <p>PRC 40 (AC/DC) - 40 Amps Resistive at 240V AC/24V DC/ Enclosed</p>	PRC 40 1P 12	12V DC	4	353
	PRC 40 1P 24	24V DC	4	361
	PRC 40 1P 24A	24V AC	4	425
	PRC 40 1P 240A	240V AC	4	386
 <p>PRC 60 (AC/DC) - 60 Amps Resistive at 240V AC/24V DC/ Enclosed</p> <p>PRC 80 (AC/DC)-80 Amps Resistive at 240V AC/24V DC/ Enclosed</p> <p>PRC 100 (AC/DC) - 100 Amps Resistive at 240V AC/24V DC/ Enclosed</p>	PRC 60 1P 12	12V DC	4	399
	PRC 60 1P 24	24V DC	4	409
	PRC 60 1P 240A	240V AC	4	487
	PRC 80 1P 12	12V DC	3	512
	PRC 80 1P 24	24V DC	3	526
	PRC 80 1P 240A	240V AC	3	689
	PRC 100 1P 12	12V DC	3	737
	PRC 100 1P 24	24V DC	3	768
	PRC 100 1P 240A	240V AC	3	790

Relay Modules (8536)

1 & 2 Changeovers with 2,4,6 & 8 channels

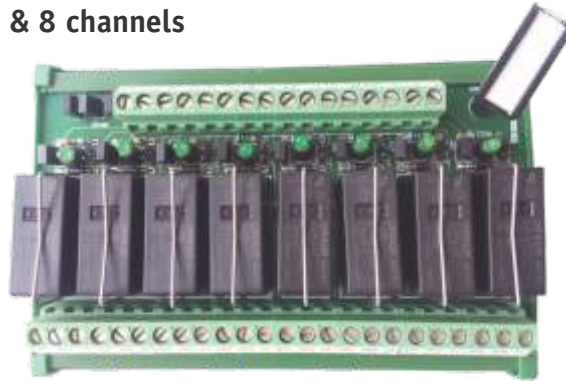

RELAYS

1 C/O RELAY MODULE

	Description	Modules	Cat No.	MRP (₹) Per Unit
	1 CO, 24VDC with OMRON Relay	2	RMS021P24	448
	1 CO, 24VDC with OMRON Relay	4	RMS041P24	823
	1 CO, 24VDC with OMRON Relay	8	RMS081P24	1383

2 C/O RELAY MODULE

	Description	Modules	Cat No.	MRP (₹) Per Unit
	2 CO, 24VDC with OMRON Relay	2	RMS022P24	591
	2 CO, 24VDC with OMRON Relay	4	RMS042P24	1031
	2 CO, 24VDC with OMRON Relay	8	RMS082P24	1983

1 C/O RELAY MODULE

	Description	Modules	Cat No.	MRP (₹) Per Unit
	1 CO, 230VAC with OMRON Relay	2	RMS021P230AC	906
	1 CO, 230VAC with OMRON Relay	4	RMS041P230AC	1752
	1 CO, 230VAC with OMRON Relay	8	RMS081P230AC	3419

2 C/O RELAY MODULE

	Description	Modules	Cat No.	MRP (₹) Per Unit
	2 CO, 230VAC with OMRON Relay	2	RMS022P230AC	1031
	2 CO, 230VAC with OMRON Relay	4	RMS042P230AC	1919
	2 CO, 230VAC with OMRON Relay	8	RMS082P230AC	3830

* Other Coil Voltages offered on request