

📍 SURAT

B-Wing, G-17 Silicon Shoppers,
Opp. Satyanagar,
Nr. SMC South Zone Office,
Udhna Main Road, Udhna, 394210

📍 AHMEDABAD

4, Ground Floor Ramakrishna Chamber,
Sakar Bazar, Kalupur, 380002



ph: +91 9429519393

E-mail: elitaelectrified@gmail.com

ELITA ELECTRIFIED

Exporter and Supplier of a

Wide Range of Terminal Blocks
and Other Motors / Generator Spares

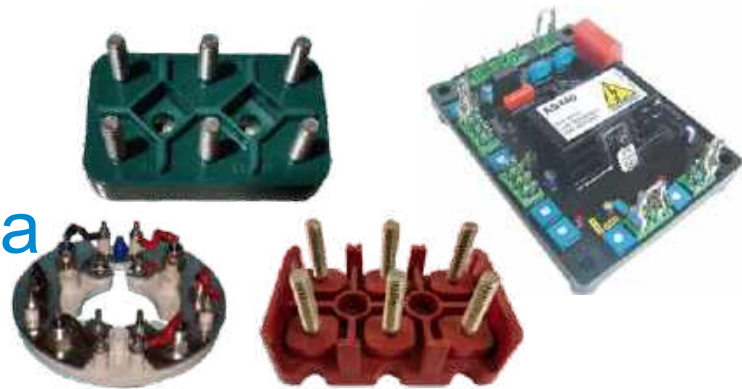

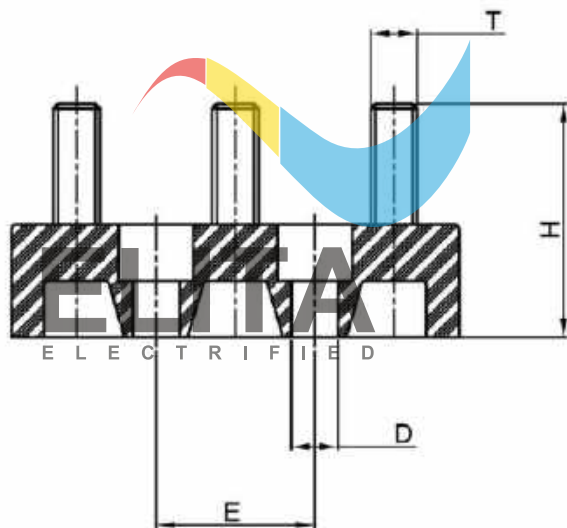
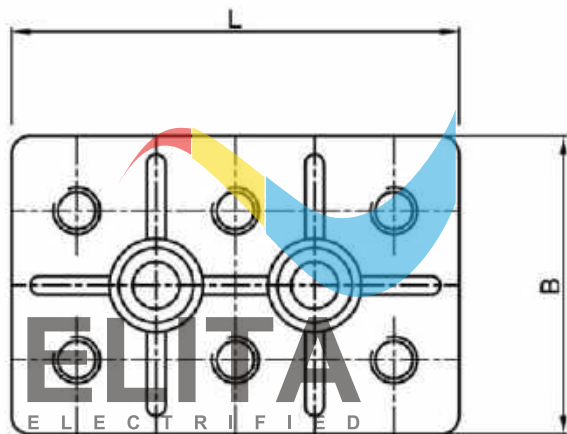

REFERENCE ABBREVIATIONS

- L LENGTH OF THE TERMINAL BLOCK
- B WIDTH OF THE TERMINAL BLOCK
- E CENTRE DISTANCE BETWEEN THE TWO HOLES
- D DIAMETER OF THE FIXING HOLES
- H TOTAL HEIGHT OF THE BLOCK WITH THE INSERT
- T THREADING OF THE INSERT IN mm



**SUITABLE FOR SIEMENS
TYPE 1 / 2 HP**

DRG NO.	L	B	E	D	H	T
EF-8136	45	30	15	9	21	M4



**SUITABLE FOR SIEMENS
TYPE 1 / 2 HP**

DRG NO.	L	B	E	D	H	T
EF-8137	45	30	15	9	21	M4



**SUITABLE FOR
TYPE 1 HP**

DRG NO.	L	B	E	D	H	T
EF-8001	50	32	20	7	25	M5



**SUITABLE FOR
TYPE 1 HP(1PH)**

DRG NO.	L	B	E	D	H	T
EF-8002	50	30	20	7	25	M5

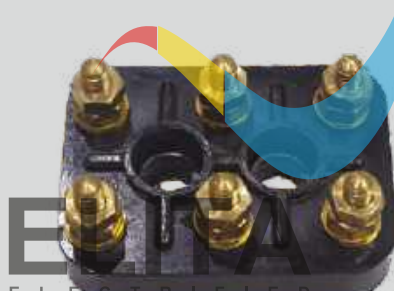

**SUITABLE FOR
TYPE 1 HP (3PH)**

DRG NO.	L	B	E	D	H	T
EF-8003	50	30	20	7	25	M5



**SUITABLE FOR
TYPE 2 HP**

DRG NO.	L	B	E	D	H	T
EF-8004	55	40	20	7.5	25	M5

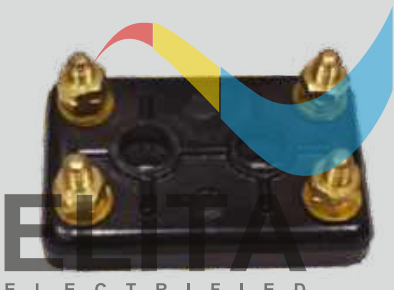

**SUITABLE FOR
TYPE 2 HP (1PH)**

DRG NO.	L	B	E	D	H	T
EF-8005	55	40	20	7.5	25	M5



**SUITABLE FOR
TYPE 2 HP (3ph)**

DRG NO.	L	B	E	D	H	T
EF-8006	55	40	20	7.5	25	M5



**SUITABLE FOR
TYPE 3 HP**

DRG NO.	L	B	E	D	H	T
EF-8007	70	45	24	7	29	M6



ELECTRIFIED

SUITABLE FOR
TYPE 3 HP

DRG NO.	L	B	E	D	H	T
EF-8008	70	45	24	7	29	M6



ELECTRIFIED

SUITABLE FOR
TYPE 5 - 10 HP

DRG NO.	L	B	E	D	H	T
EF-8009	70	45	24	7	29	M6



ELECTRIFIED

SUITABLE FOR
TYPE 15 HP (1PH)

DRG NO.	L	B	E	D	H	T
EF-8010	82	53	30	8	30	M6

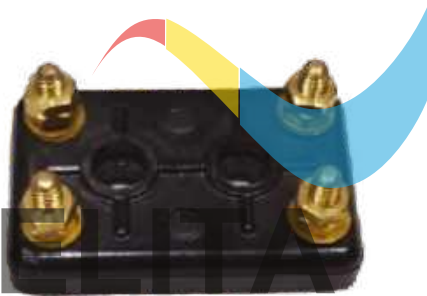

ELECTRIFIED

SUITABLE FOR
TYPE 15 HP (1PH)

DRG NO.	L	B	E	D	H	T
EF-8011	82	53	30	8	30	M6



ELECTRIFIED

SUITABLE FOR
TYPE 15 HP (3PH)

DRG NO.	L	B	E	D	H	T
EF-8012	82	53	30	8	30	M6

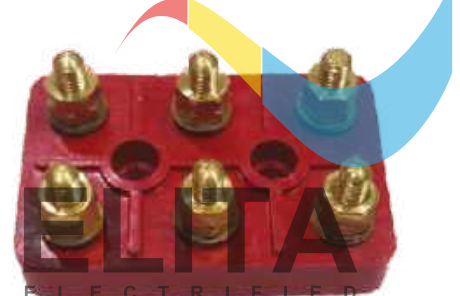

ELECTRIFIED

SUITABLE FOR
TYPE 15 TO 20 HP

DRG NO.	L	B	E	D	H	T
EF-8014	95	60	36	9	39	M8



ELECTRIFIED

SUITABLE FOR
TYPE 50 HP

DRG NO.	L	B	E	D	H	T
EF-8015/16	113	70	40	9	40	M8 M10



ELECTRIFIED

SUITABLE FOR
TYPE 60 HP

DRG NO.	L	B	E	D	H	T
EF-8017	134	75	ADJ	ADJ	57	M10

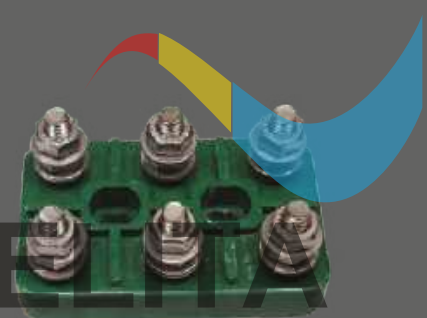

ELECTRIFIED

SUITABLE FOR
TYPE 120 TO 150 HP

DRG NO.	L	B	E	D	H	T
EF-8018	180	110	68	12	74	M16



SUITABLE FOR
TYPE 100 HP

DRG NO.	L	B	E	D	H	T
EF-8147	150	90	45	7	55	M12



SUITABLE FOR
TYPE 1/2 HP

DRG NO.	L	B	E	D	H	T
EF-8036	33	33	1HOLE	5	20	M4



SUITABLE FOR
TYPE 1 HP

DRG NO.	L	B	E	D	H	T
EF-8037	50	50	1HOLE	5	25	M5

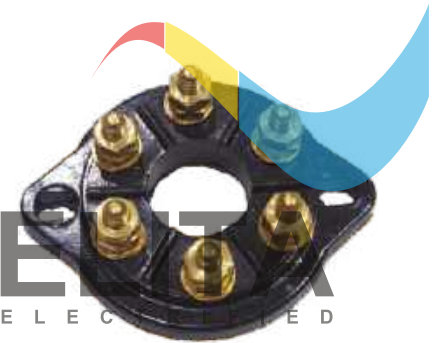

SUITABLE FOR
TYPE BCON

DRG NO.	L	B	E	D	H	T
EF-8034	88	R67	71	10	28	M6

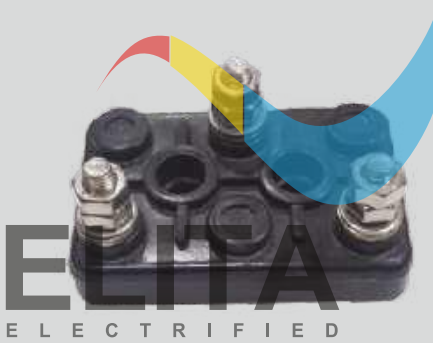

SUITABLE FOR
TYPE CR 5 HP

DRG NO.	L	B	E	D	H	T
EF-8020	73	46	26	7.5	33	M6



SUITABLE FOR
TYPE CR 5 HP 6

DRG NO.	L	B	E	D	H	T
EF-8021	73	46	26	7.5	33	M6

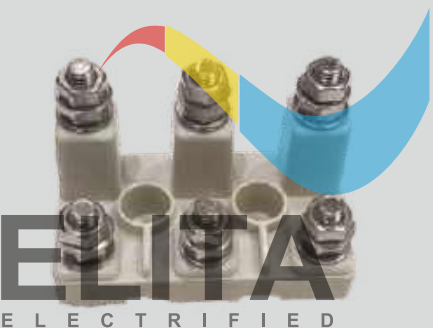

SUITABLE FOR
TYPE CR 15 HP

DRG NO.	L	B	E	D	H	T
EF-8022	91	50	35	9	62/35	M6



SUITABLE FOR
TYPE CR 25 TO 30 HP

DRG NO.	L	B	E	D	H	T
EF-8023	97	50	36	8.5	70/40	M8



SUITABLE FOR
TYPE 150 HP

DRG NO.	L	B	E	D	H	T
EF-8024	300	60	279	12	60	M12

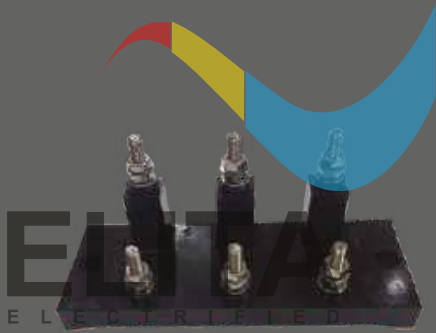

SUITABLE FOR
TYPE CR 50 HP

DRG NO.	L	B	E	D	H	T
EF-8025	208	78	185	10	80/46	M8

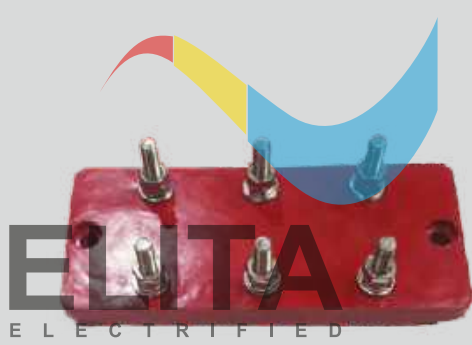

SUITABLE FOR
TYPE CR 60 HP OLD

DRG NO.	L	B	E	D	H	T
EF-8019-A	181	75	164	8	60	M8

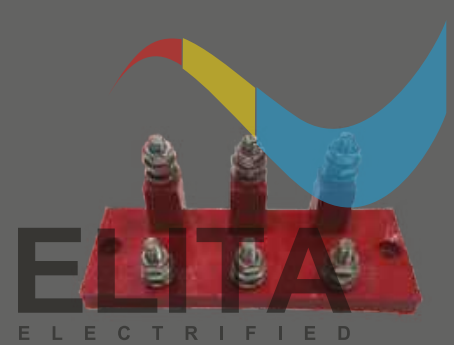

SUITABLE FOR
TYPE CR 75 HP

DRG NO.	L	B	E	D	H	T
EF-8019-B	208	78	185	10	80/46	M10

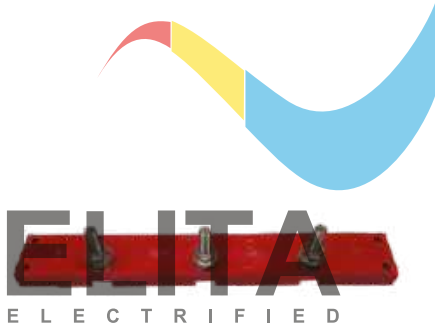

SUITABLE FOR TYPE
CR 250 TO 300 HP

DRG NO.	L	B	E	D	H	T
EF-8131	385	57	363	10	80	M12/16



SUITABLE FOR
TYPE CR 50 HP

DRG NO.	L	B	E	D	H	T
EF-8044	140	85	40	10	70	M10

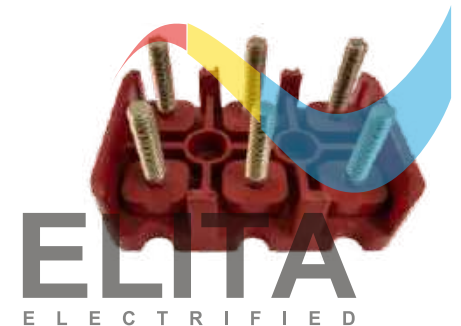

SUITABLE FOR
TYPE CR 150 HP

DRG NO.	L	B	E	D	H	T
EF-8045	170	105	55	11	85	M12



CR New 118 X 69

DRG NO.	L	B	E	D	H	T
EF-8117	118	69	39.5	8	60	M8

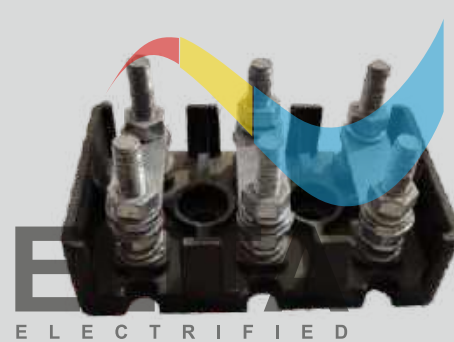

CR New 90 X 60

DRG NO.	L	B	E	D	H	T
EF-8116	90	60	30	6	46	M6



CR 5 HP 6

DRG NO.	L	B	E	D	H	T
EF-8026	73	46	25	8	35	M6

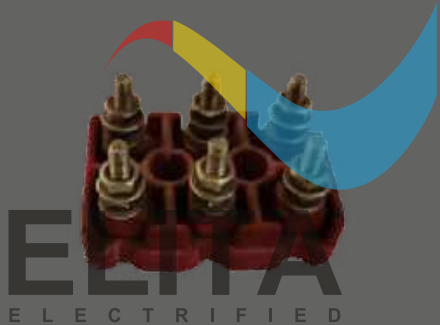

SUITABLE FOR
TYPE CR 1-2 HP

DRG NO.	L	B	E	D	H	T
EF-8181	50	31	19	6	30	M4



SUITABLE FOR
TYPE CR 5-7.5 HP

DRG NO.	L	B	E	D	H	T
EF-8182	73	43	25	6.5	39.5	M6

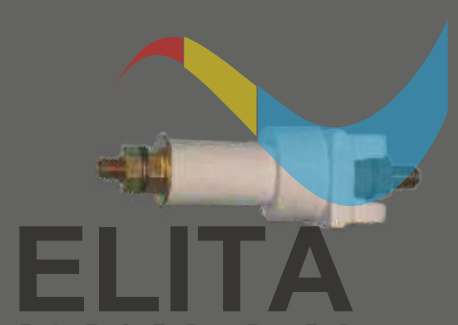

SUITABLE FOR
TYPE CR 5-7.5 HP

DRG NO.	L	B	E	-	H	T
EF-8046	33	28	16	-	89	M8

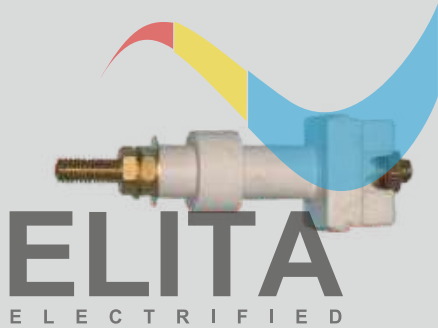

SUITABLE FOR
TYPE CR FLP 5-10 HP

DRG NO.	L	B	E	-	H	T
EF-8047	28	23	11	-	80	M6

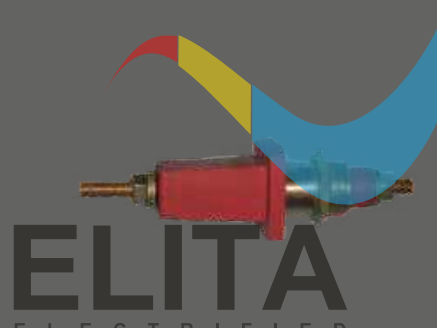

SUITABLE FOR
TYPE CR FLP 15-20 HP

DRG NO.	L	B	-	D	H	T
EF-8156	140	40	-	25	140	M8



SUITABLE FOR
TYPE CR FLP 15-20 HP

DRG NO.	L	B	D	H	T
EF-8155	100	40	25	100	M8

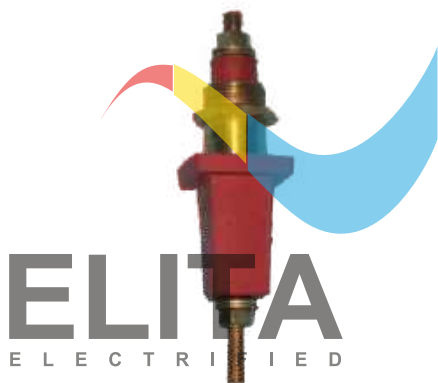

SUITABLE FOR
TYPE CR FLP 50-75HP

DRG NO.	L	B	D	H	T
EF-8157	160	49	30	160	M8/M10



SUITABLE FOR
TYPE CR FLP 50-75HP

DRG NO.	L	B	D	H	T
EF-8158	120	50	30	120	M8/M10



SUITABLE FOR
TYPE Y 80

DRG NO.	L	B	E	D	H	T
EF-8027	55	33	20	6	26	M4

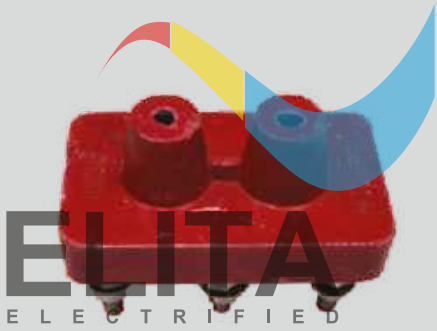

SUITABLE FOR
TYPE Y 90 - 112

DRG NO.	L	B	E	D	H	T
EF-8028	68	40.5	25	6	31	M5

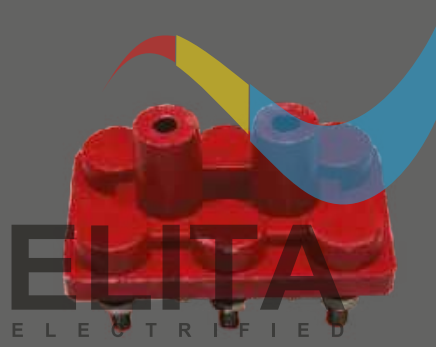

SUITABLE FOR
TYPE Y 132

DRG NO.	L	B	E	D	H	T
EF-8029	85	51	30	7.2	42	M6

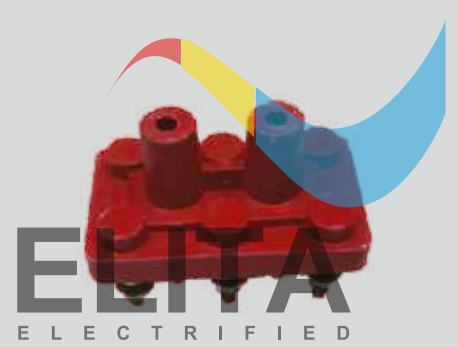

DRG NO.	L	B	E	D	H	T
EF-8030	110	67	40	8	50	M8

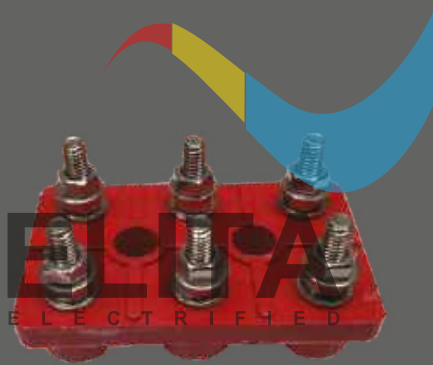

SUITABLE FOR
TYPE Y 200

DRG NO.	L	B	E	D	H	T
EF-8031	145	88	50	10	72	M10

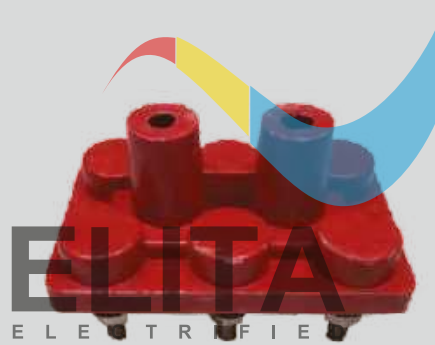

SUITABLE FOR
TYPE Y 250

DRG NO.	L	B	E	D	H	T
EF-8032	158	100	55	13	80	M12



SUITABLE FOR
TYPE Y 280 - 315

DRG NO.	L	B	E	D	H	T
EF-8033	180	105	65	12	12	90

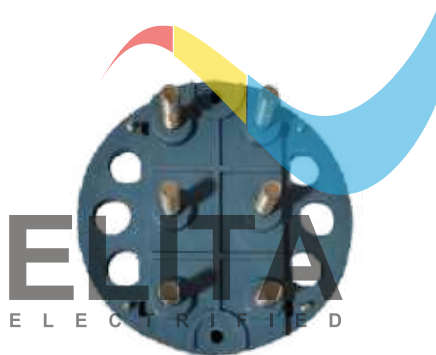

SUITABLE FOR
TYPE YZR 280 - 315

DRG NO.	OD	B	E	D	H	T
EF-8135	210	210	185	12	85	M12



SUITABLE FOR
TYPE YZR 355 - 400

DRG NO.	OD	B	E	D	H	T
EF-8138	250	250	215	12	95	M16

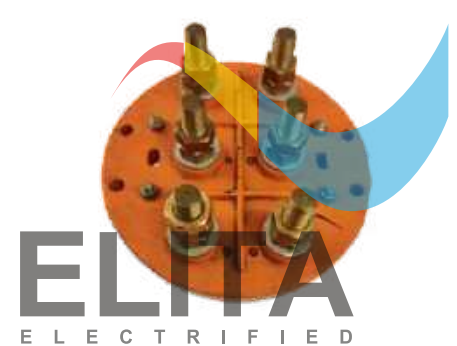

SUITABLE FOR
TYPE Y2 - 315

DRG NO.	OD	B	E	D	H	T
EF-8180	210	210	180	12	135	M16



Y2 355 M20 Brass Bolt

DRG NO.	OD	B	E	D	H	T
EF-8190	250	250	200X80	12	140	M20



Y2 315 / 350 brass Slot Step

DRG NO.	OD	B	E	D	H	T
EF-8112	210	120	184X50	13	120	M12



Y2 - 315 / 210 MM Rectangle

DRG NO.	L	B	E	D	H	T
EF - 8113	210	96	185	10	78	M12



Y2 - 355 / 250 MM Rectangle

DRG NO.	L	B	E	D	H	T
EF - 8114	250	112	215	12	105	M16



Y2 - 160 / 180 L

DRG NO.	L	B	E	D	H	T
EF - 8118	125	84	110	8	55	M6

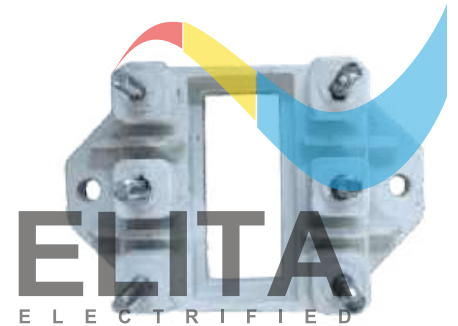

Y2 - 200 / 225 L

DRG NO.	L	B	E	D	H	T
EF - 8119	160	120	140	9	75	M8



Y2 - 250 / 280 L

DRG NO.	L	B	E	D	H	T
EF - 8120	192	130	173	10	80	M10

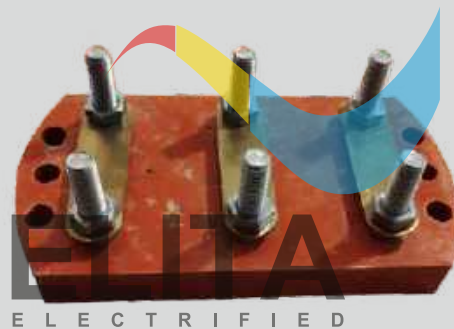

Y2 - 315 / 350 L

DRG NO.	L	B	E	D	H	T
EF - 8111	210	111	185(3 holes)	12	70	M12



Y2 - 63 / 71

DRG NO.	L	B	E	D	H	T
EF - 8115	60	39	21	5	38	M4



SUITABLE FOR TYPE TECO 1

DRG NO.	L	B	E	D	H	T
EF - 8050	85	40	70	6	30	M4

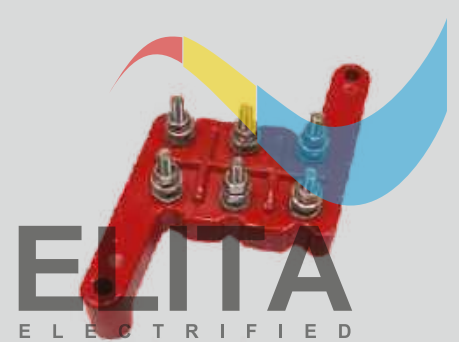

SUITABLE FOR TYPE TECO 2

DRG NO.	L	B	E	D	H	T
EF - 8051	127	55	109	8	40	M6

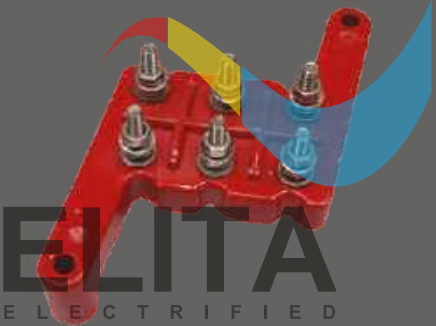

SUITABLE FOR TYPE TECO 3

DRG NO.	L	B	E	D	H	T
EF - 8052	173	57	155	7.5	43	M6



SUITABLE FOR TYPE TECO 4

DRG NO.	L	B	E	D	H	T
EF - 8053	194	95	175	12	46	M8



SUITABLE FOR TYPE TECO 5

DRG NO.	L	B	E	D	H	T
EF - 8054	250	125	225	15	60	M10



SUITABLE FOR TYPE ABB 2 HP

DRG NO.	L	B	E	D	H	T
EF - 8139	43	27	15	5.4	23	M4



SUITABLE FOR TYPE ABB 5 HP

DRG NO.	L	B	E	D	H	T
EF - 8039	53	32	22.5	7	29	M5



SUITABLE FOR TYPE ABB 5 HP

DRG NO.	L	B	E	D	H	T
EF - 8039 A	53	32	22.5	7	29	M5



ELITA
ELECTRIFIED

SUITABLE FOR
TYPE ABB NEW 15 HP

DRG NO.	L	B	E	D	H	T
EF-8176	80	55	32	7	35	M6



ELITA
ELECTRIFIED

SUITABLE FOR
TYPE BBL FLP

DRG NO.	L	B	E	D	H	T
EF-8159	126	20	-	20	-	M6



ELITA
ELECTRIFIED

SUITABLE FOR
TYPE BBL FLP 15-20 HP

DRG NO.	L	B	E	D	H	T
EF-8159	120	32	-	24	-	M8



ELITA
ELECTRIFIED

SUITABLE FOR
TYPE ABB 15 -20 HP

DRG NO.	L	B	E	D	H	T
EF-8081	83	50	32	8	40	M8



ELITA
ELECTRIFIED

SUITABLE FOR
TYPE ABB 50 -60 HP

DRG NO.	L	B	E	D	H	T
EF-8082	145	66	120	10	53	M10



ELITA
ELECTRIFIED

SUITABLE FOR
TYPE ABB 100 HP

DRG NO.	L	B	E	D	H	T
EF-8083	168	76	143	12	65	M12

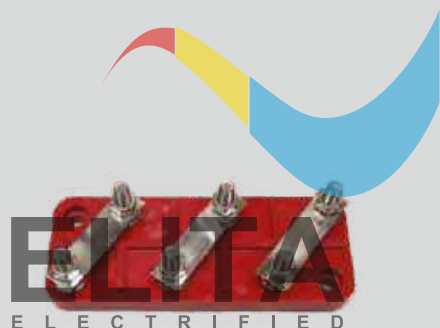

ELITA
ELECTRIFIED

SUITABLE FOR
TYPE ABB 250 - 300 HP

DRG NO.	L	B	E	D	H	T
EF-8084	300	120	280	16	75	M16



ELITA
ELECTRIFIED

SUITABLE FOR
TYPE ABB 225 / 250 M2B

DRG NO.	L	B	E	D	H	T
EF-8150	120	74	45	6	65	M10



ELITA
ELECTRIFIED

SUITABLE FOR
TYPE SIE 2 HP

DRG NO.	L	B	E	D	H	T
EF-8145	70	33	58	4	26	M4



SUITABLE FOR
TYPE GK030

DRG NO.	L	B	E	D	H	T
EF-8141	51	33	20	4	23	M4



SUITABLE FOR
TYPE GK130

DRG NO.	L	B	E	D	H	T
EF-8055	58	35	51	4	35	M4

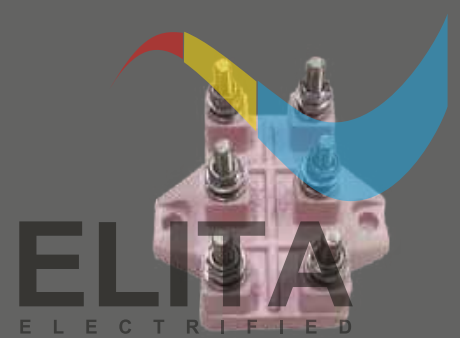

SUITABLE FOR
TYPE GK230

DRG NO.	L	B	E	D	H	T
EF-8056	65	40	58	5	46	M5



SUITABLE FOR
TYPE GK330

DRG NO.	L	B	E	D	H	T
EF-8057	85	54	75	8	50	M5



SUITABLE FOR
TYPE GK430

DRG NO.	L	B	E	D	H	T
EF-8066	83	65	86	8	50	M6

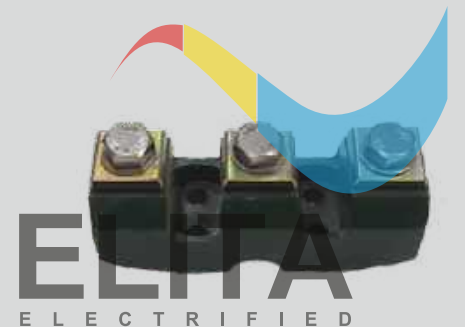

SUITABLE FOR
TYPE SIE / BBL 20 HP

DRG NO.	L	B	E	D	H	T
EF-8058	83	23	30	4	40	M6

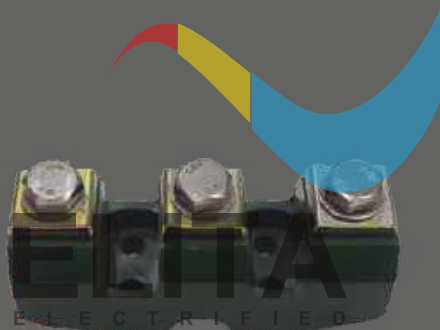

SUITABLE FOR
TYPE SIE / BBL 40 HP

DRG NO.	L	B	E	D	H	T
EF-8059	105	27	38	8	45	M8

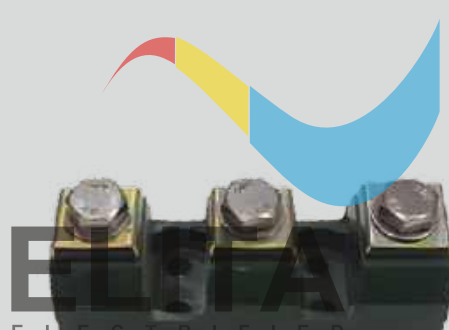

SUITABLE FOR
TYPE SIE / BBL 60 HP

DRG NO.	L	B	E	D	H	T
EF-8060	125	43	50	8	55	M10

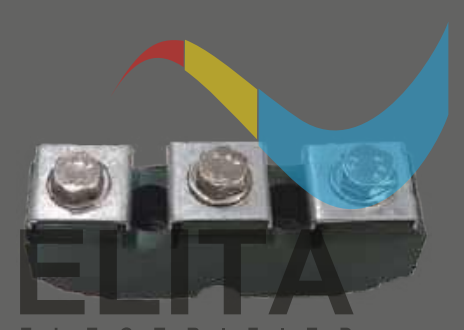

SUITABLE FOR TYPE
SIE / BBL 100 HP

DRG NO.	L	B	E	D	H	T
EF-8061	144	47	55	8	60	M10/M12

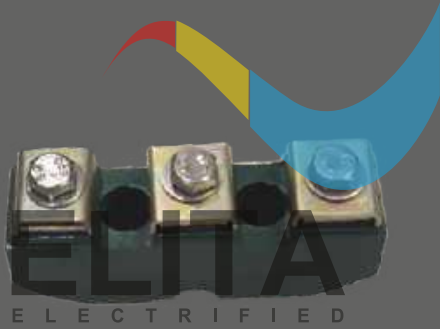

SUITABLE FOR TYPE SIE /
BBL / BHEL 300-500 HP

DRG NO.	L	B	E	D	H	T
EF - 8062	180	55	67	10	80	M16



SUITABLE FOR
TYPE SIE 100 HP

DRG NO.	L	B	E	D	H	T
EF - 8063	180	180	127	12	120	M10



SUITABLE FOR
TYPE SIE 120 HP

DRG NO.	L	B	E	D	H	T
EF - 8064	210	210	160	12	140	M12



SUITABLE FOR
TYPE SIE 250-300 HP

DRG NO.	L	B	E	D	H	T
EF - 8065	279	279	190	16	180	M16

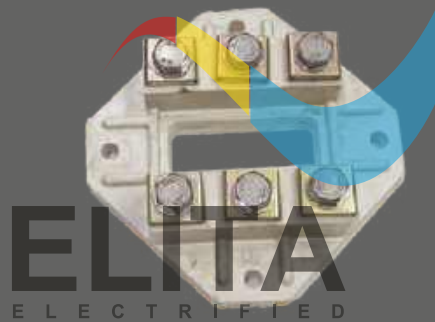

SUITABLE FOR
TYPE SIE 50 HP

DRG NO.	L	B	E	D	H	T
EF - 8067	140	140	140	8	55	M8/M10



SUITABLE FOR
TYPE SIE 100 HP

DRG NO.	L	B	E	D	H	T
EF - 8068	168	168	170	10	95X70	M10/M12



SUITABLE FOR
TYPE SIE GERMAN 100 HP

DRG NO.	L	B	E	D	H	T
EF - 8148	195	105	170	10	96	M12



SUITABLE FOR
TYPE SIE GERMAN 50 HP

DRG NO.	L	B	E	D	H	T
EF - 8149	156	104	141	10	78	M10



SUITABLE FOR
TYPE BBL 500 HP

DRG NO.	L	B	E	D	H	T
EF - 8154	275	275	245	11	150	M16



SUITABLE FOR
TYPE SIE GERMAN 300 HP

DRG NO.	L	B	E	D	H	T
EF-8108	256	152	230	14	122	M16



SUITABLE FOR
TYPE SIE / HM 5-10 HP

DRG NO.	L	B	E	D	H	T
EF-8142	70	43	25	6	30	M5

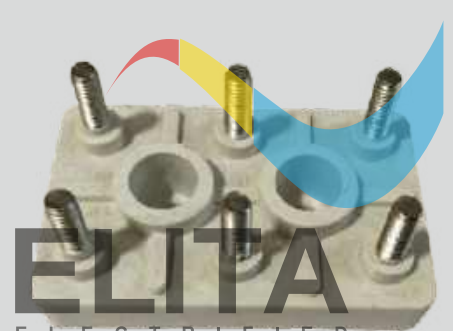

SUITABLE FOR
TYPE SIE / HM 15-20 HP

DRG NO.	L	B	E	D	H	T
EF-8188	80	55	30	8	45	M6

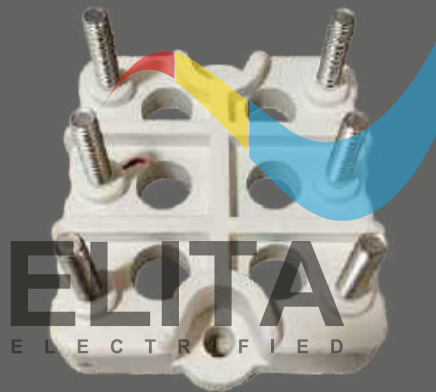

SUITABLE FOR
TYPE SIE OLD 15 HP

DRG NO.	L	B	E	D	H	T
EF-8177	90	80	76	6	47	M6

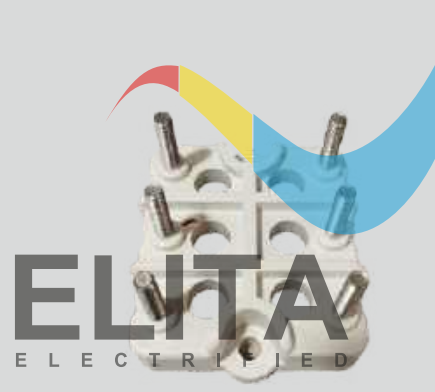

SUITABLE FOR
TYPE SIE OLD 40 HP

DRG NO.	L	B	E	D	H	T
EF-8178	110	100	95	10	57	M8



SUITABLE FOR
TYPE SIE OLD 75 HP

DRG NO.	L	B	E	D	H	T
EF-8179	138	121	114	12	70	M10

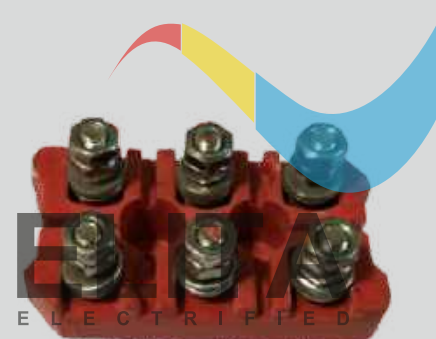

SUITABLE FOR
TYPE GN SIZE 1

DRG NO.	L	B	E	D	H	T
EF-8161	52	28	16	4	27	M4

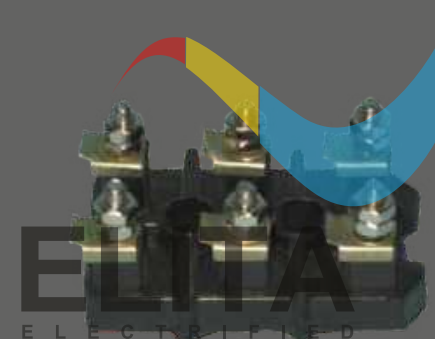

SUITABLE FOR
TYPE GN 112

DRG NO.	L	B	E	D	H	T
EF-8184	61	35	20	4	40	M4

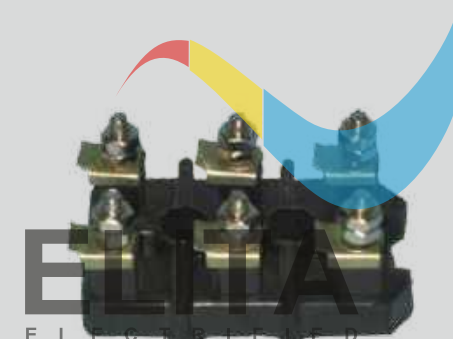

SUITABLE FOR
TYPE GN 132

DRG NO.	L	B	E	D	H	T
EF-8185	69	40	25	5	42	M5

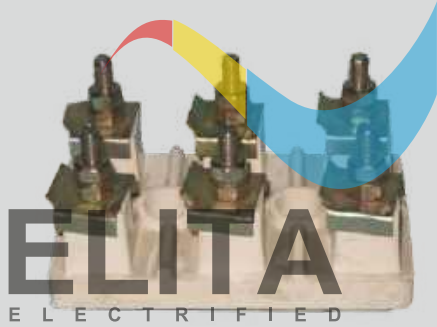

SUITABLE FOR
TYPE GN160

DRG NO.	L	B	E	D	H	T
EF-8186	85	55	30	6	48	M5



SUITABLE FOR
TYPE GN200

DRG NO.	L	B	E	D	H	T
EF-8187	104	64	40	8	65	M6

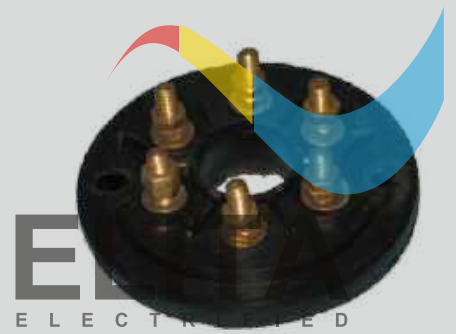

SUITABLE FOR
TYPE NGEF 3 HP

DRG NO.	OD	E	D	H	T
EF-8069	70.5	57	9X6	31	M5

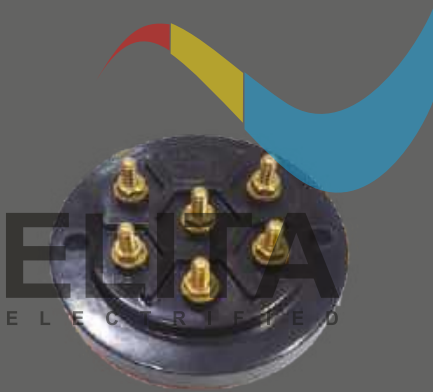

SUITABLE FOR
TYPE NGEF 10 HP

DRG NO.	OD	E	D	H	T
EF-8070	88	73	9X6	37	M6



SUITABLE FOR
TYPE NGEF 15-20 HP

DRG NO.	OD	E	D	H	T
EF-8071	115	97	10x7	46	M6



SUITABLE FOR
TYPE NGEF 40 HP

DRG NO.	OD	E	D	H	T
EF-8072	140	116	11X10	75	M8



SUITABLE FOR
TYPE NGEF 75HP

DRG NO.	L	B	E	D	H	T
EF-8073	175	175	140	12	95	M10

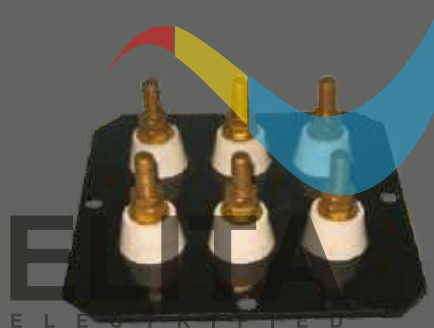

SUITABLE FOR TYPE
NGEF 100 - 120HP

DRG NO.	L	B	E	D	H	T
EF-8074	215	215	206	12	120	M12

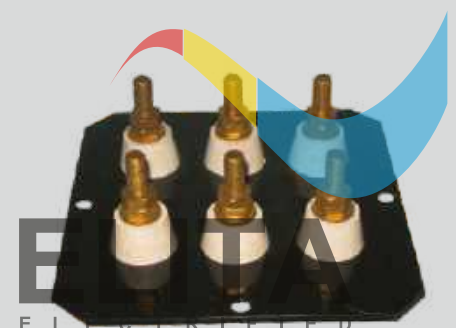

SUITABLE FOR
TYPE NGEF 200 HP

DRG NO.	L	B	E	D	H	T
EF-8075	285	285	265	12	150	M16

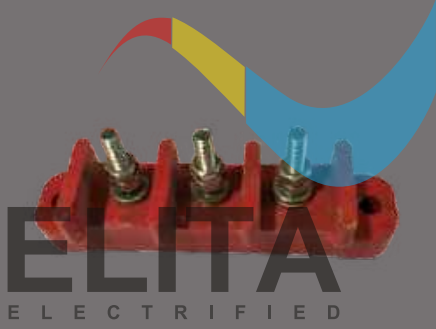

SUITABLE FOR
TYPE GEC/MARATHON 10 HP

DRG NO.	L	B	E	D	H	T
EF-8166	125	26	106	6	45	M6



SUITABLE FOR
TYPE GEC/MARATHON 20 HP

DRG NO.	L	B	E	D	H	T
EF 8076	145	30	120	10	55	M8/M6



SUITABLE FOR
TYPE GEC/MARATHON
5 HP BLOWER

DRG NO.	L	B	H	T
EF 8164	60	30	50	M5

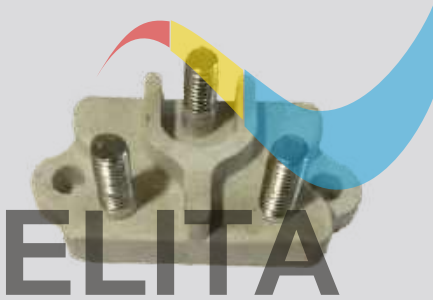

SUITABLE FOR
TYPE GEC/MARATHON
2 - 3 HP BLOWER

DRG NO.	L	B	E	D	H	T
EF 8165	60	29	58	6	40	M6



SUITABLE FOR MARATHON
IE4 - 5 HP

DRG NO.	L	B	E	D	H	T
EF 8191	70	50	22.5	5	40	M5



SUITABLE FOR MARATHON
IE4 - 10 HP

DRG NO.	L	B	E	D	H	T
EF 8192	80	53	25.4	5	40	M5



SUITABLE FOR
TYPE GEC/MARATHON 2 HP

DRG NO.	L	B	E	D	H	T
EF-8040	63	37	43	6.5	27	M6



SUITABLE FOR
TYPE GEC/MARATHON 5-10 HP

DRG NO.	L	B	E	D	H	T
EF-8144	60	40	42	4	35	M6

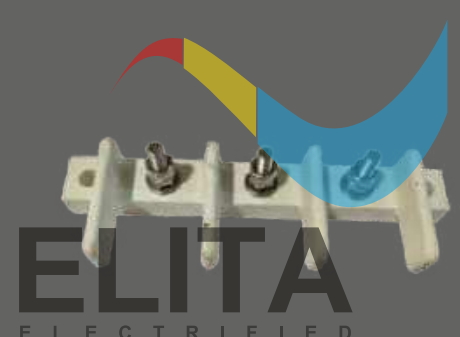

SUITABLE FOR
TYPE GEC/MARATHON 40 HP

DRG NO.	L	B	E	D	H	T
EF 8167	200	25	174	10	60	M8

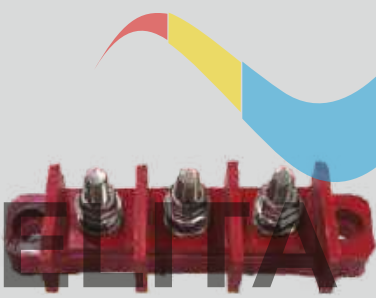

ELECTRIFIED

SUITABLE FOR
TYPE GEC/MARATHON 40 HP

DRG NO.	L	B	E	D	H	T
EF-8077	200	40	174	10	70	M12



ELECTRIFIED

SUITABLE FOR
TYPE GEC/MARATHON 60 HP

DRG NO.	L	B	E	D	H	T
EF-8078	240	50	215	10	75	M12/M16



ELECTRIFIED

SUITABLE FOR
TYPE GEC/MARATHON 100 HP

DRG NO.	L	B	E	D	H	T
EF-8079	272	40	246	10	60	M12



ELECTRIFIED

SUITABLE FOR
TYPE GEC/MARATHON
150 -200 HP

DRG NO.	L	B	E	D	H	T
EF-8080	324	47	295	14	70	M12



ELECTRIFIED

SUITABLE FOR
TYPE KR PRIME 5 HP

DRG NO.	L	B	E	D	H	T
EF-8085	55	34	20	6	30	M5

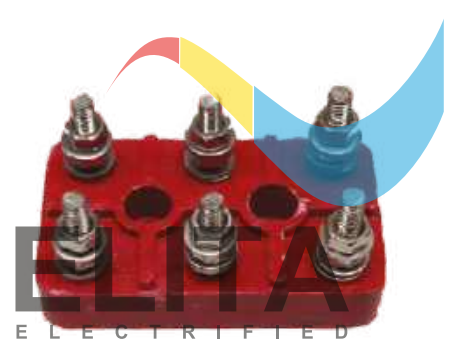

ELECTRIFIED

SUITABLE FOR
TYPE KR PRIME 5 HP

DRG NO.	L	B	E	D	H	T
EF-8086	55	34	20	6	30	M5

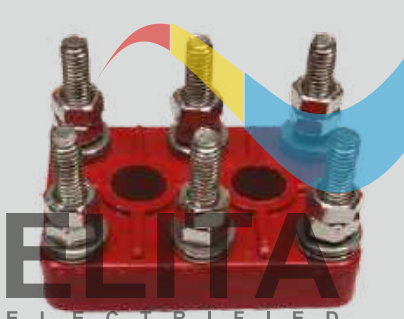

ELECTRIFIED

SUITABLE FOR TYPE KR
PRIME 15 HP

DRG NO.	L	B	E	D	H	T
EF-8087	65	45	25	7	50	M6



ELECTRIFIED

SUITABLE FOR
TYPE KR 1-3 HP

DRG NO.	L	B	E	D	H	T
EF-8096	55	27	48	6	26	M5



ELECTRIFIED

SUITABLE FOR
TYPE KR 1-3 HP

DRG NO.	L	B	E	D	H	T
EF-8097	55	27	48	6	26	M5



ELITA
ELECTRIFIED

SUITABLE FOR
TYPE KR 5-10 HP

DRG NO.	L	B	E	D	H	T
EF-8098	77	35	64	6	31	M6



ELITA
ELECTRIFIED

SUITABLE FOR
TYPE KR 5-10 HP

DRG NO.	L	B	E	D	H	T
EF-8099	77	35	64	6	31	M6



ELITA
ELECTRIFIED

SUITABLE FOR
TYPE KR 15-20 HP OLD

DRG NO.	L	B	E	D	H	T
EF-8100	86	50	66	6	43	M6



ELITA
ELECTRIFIED

SUITABLE FOR
TYPE KR 15-20 HP

DRG NO.	L	B	E	D	H	T
EF-8092	115	75	109	6	47	M6



ELITA
ELECTRIFIED

SUITABLE FOR
TYPE KR 50 HP

DRG NO.	L	B	E	D	H	T
EF-8093	180	126	178	10	65	M10

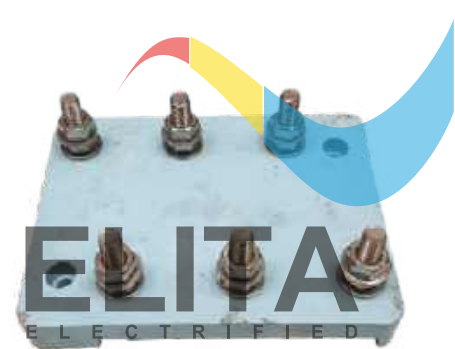

ELITA
ELECTRIFIED

SUITABLE FOR
TYPE KR 100-120 HP

DRG NO.	L	B	E	D	H	T
EF-8094	200	150	185	9	70	M12



ELITA
ELECTRIFIED

SUITABLE FOR
TYPE KR 40-60 HP

DRG NO.	L	B	E	D	H	T
EF-8102	146	82	138	11	66	M10



ELITA
ELECTRIFIED

SUITABLE FOR
TYPE KR 40 HP

DRG NO.	L	B	E	D	H	T
EF-8101	150	82	140	10	50	M8

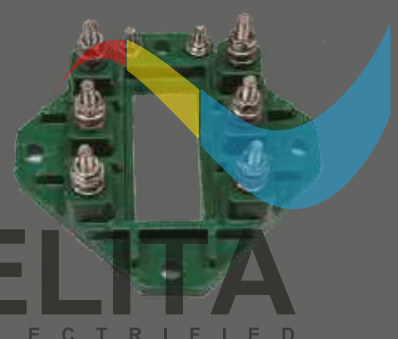

ELITA
ELECTRIFIED

SUITABLE FOR
TYPE KR / Y2-160-180

DRG NO.	L	B	E	D	H	T
EF-8089	105	105	110	7	60	M6

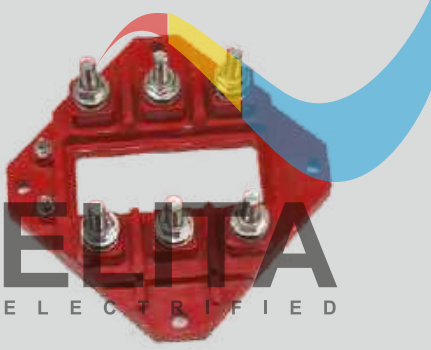

SUITABLE FOR TYPE
KR / Y2-200-225

DRG NO.	L	B	E	D	H	T
EF-8090	140	140	140	9	75	M8

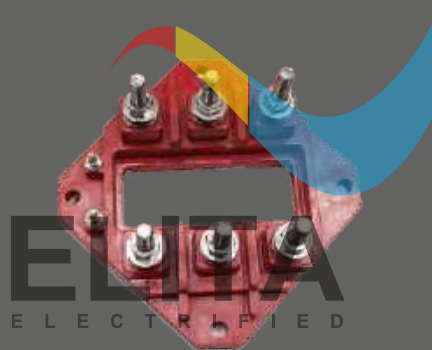

SUITABLE FOR
TYPE KR / Y2-250-280

DRG NO.	L	B	E	D	H	T
EF 8091	155	155	170	10	85	M10



SUITABLE FOR
TYPE KR 75 HP

DRG NO.	L	B	E	D	H	T
EF - 8041	253	40	230	12	55	M12

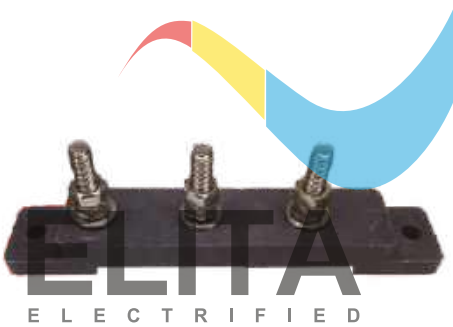

SUITABLE FOR
TYPE KR 75 HP

DRG NO.	L	B	E	D	H	T
EF - 8013	256	48	230	12	73	M12



SUITABLE FOR
TYPE KR 1 HP

DRG NO.	L	B	E	D	H	T
EF - 8042	41	23	1HOLE	6	25	M5

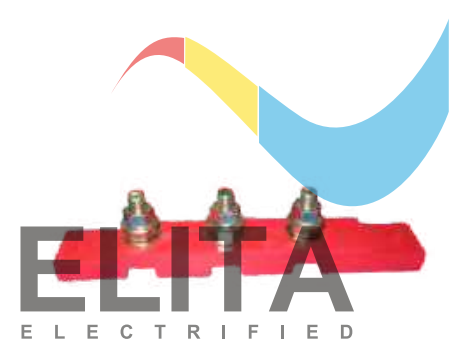

SUITABLE FOR
TYPE KR 150 HP

DRG NO.	L	B	E	D	H	T
EF - 8146	331	50	294	16	75	M16

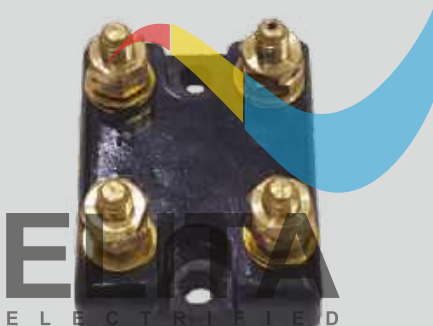

SUITABLE FOR
TYPE TEXMO 2-3 HP

DRG NO.	L	B	E	D	H	T
EF - 8105	53	40	42	5	32	M6



SUITABLE FOR
TYPE TEXMO 5 HP

DRG NO.	L	B	E	D	H	T
EF - 8106	74	45	64	6	35	M6

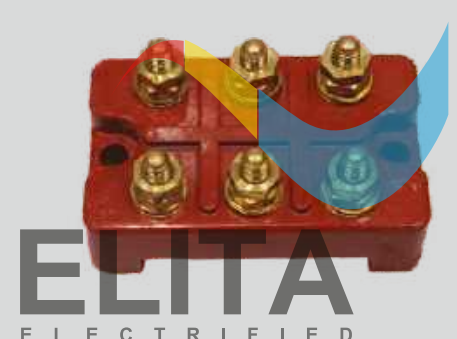

SUITABLE FOR
TYPE TEXMO 10 HP

DRG NO.	L	B	E	D	H	T
EF - 8107A	78	55	65	7	42	M6



SUITABLE FOR TYPE
TEXMO/LUBI 10 HP

DRG NO.	L	B	E	D	H	T
EF-8107	80	40	70	8	35	M6



SUITABLE FOR
TYPE TEXMO 1/2 HP

DRG NO.	L	B	E	D	H	T
EF-8103	30	30	1 HOLE	5.2	24	M5

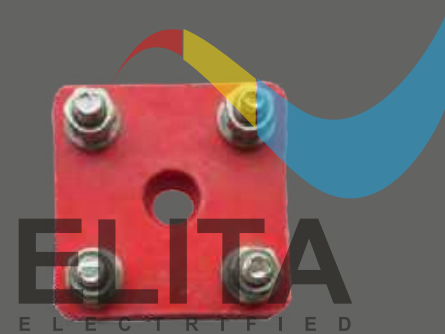

SUITABLE FOR
TYPE TEXMO 1-2 HP

DRG NO.	L	B	E	D	H	T
EF-8104	40	40	1 HOLE	7.2	25	M5



SUITABLE FOR
TYPE EUROPEAN 3 HP

DRG NO.	L	B	E	D	H	T
EF-8168	50	32	18	8X5	19	M4

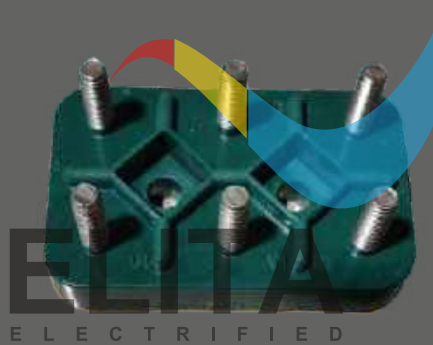

SUITABLE FOR TYPE 5 HP
MOTOR (KM 5)

DRG NO.	L	B	E	D	H	T
EF-8169	64	40	23	6	28	M5

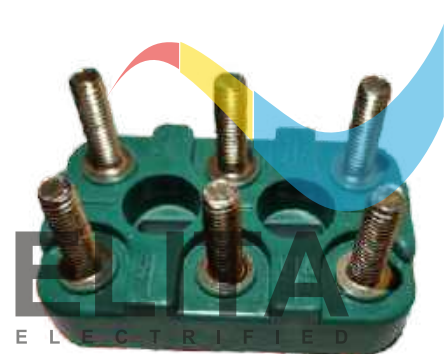

SUITABLE FOR
TYPE EUROPEAN - 5 HP

DRG NO.	L	B	E	D	H	T
EF-8170	56	36	21	9X6	28	M5



SUITABLE FOR
TYPE EUROPEAN - 10 HP

DRG NO.	L	B	E	D	H	T
EF-8171	71	46	25	11X7	34	M6



SUITABLE FOR TYPE
EUROPEAN - 15-20 HP

DRG NO.	L	B	E	D	H	T
EF-8172	82	52	30	12X7	38	M6

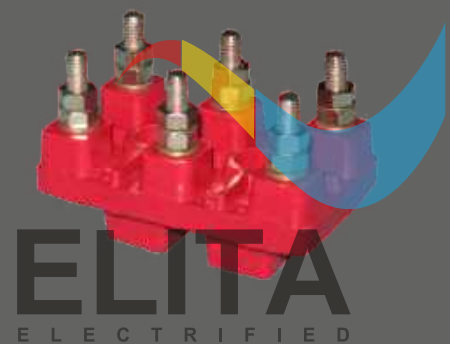

SUITABLE FOR
TYPE BBL/Y2 - 112-132

DRG NO.	L	B	E	D	H	T
EF-8189	68	40	25	7	50	M5

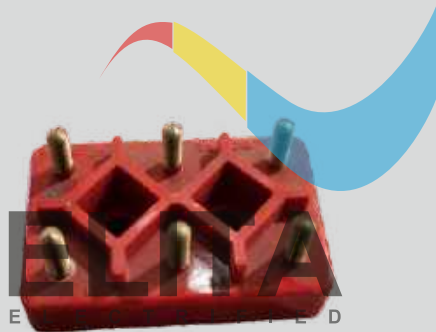

KM4

DRG NO.	L	B	E	D	H	T
EF-8173	54	34	20	6	28	M4



KM6

DRG NO.	L	B	E	D	H	T
EF-8174	77	48	28	7	34	M6



KM8

DRG NO.	L	B	E	D	H	T
EF-8175	96	60	35	7	48	M8

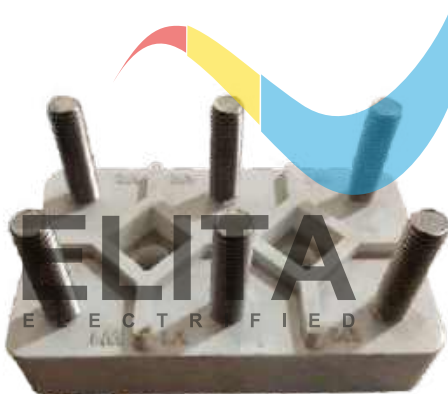

KM10

DRG NO.	L	B	E	D	H	T
EF-8151	120	75	45	9	57	M10

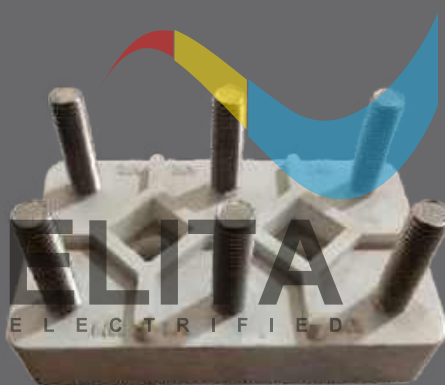

KM12

DRG NO.	L	B	E	D	H	T
EF-8109	150	95	55	14	63	M12

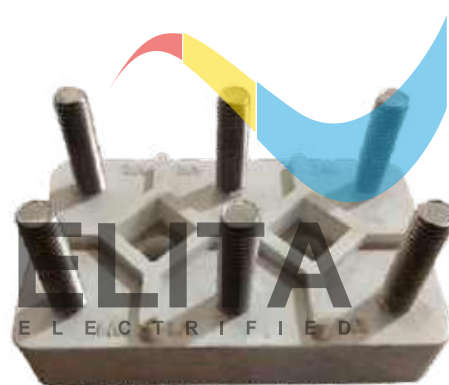

KM16

DRG NO.	L	B	E	D	H	T
EF-8110	160	100	60	14	100	M16



SUITABLE WEG 53

DRG NO.	L	B	E	D	H	T
EF-8194	53	35	20	4	34	M4



SUITABLE WEG 88

DRG NO.	L	B	E	D	H	T
EF-8195	88	58	27	6	45	M6

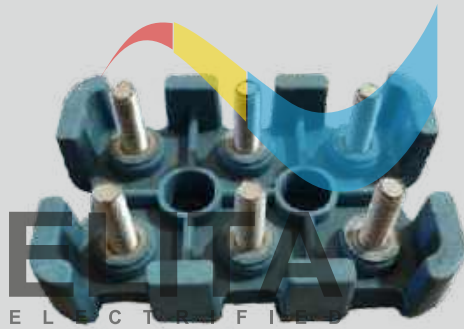

SUITABLE WEG 112

DRG NO.	L	B	E	D	H	T
EF-8196	112	75	35	9	52	M8

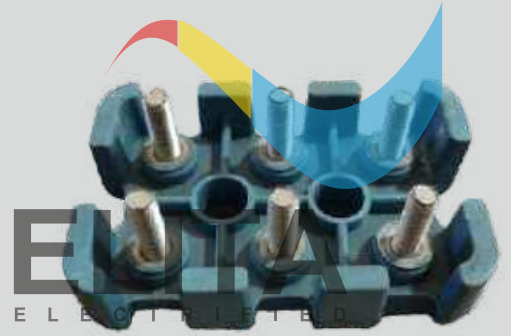

SUITABLE WEG 140

DRG NO.	L	B	E	D	H	T
EF-8197	140	94	45	12	80	M10



SUITABLE WEG 153

DRG NO.	L	B	E	D	H	T
EF-8198	153	108	45	12	85	M12

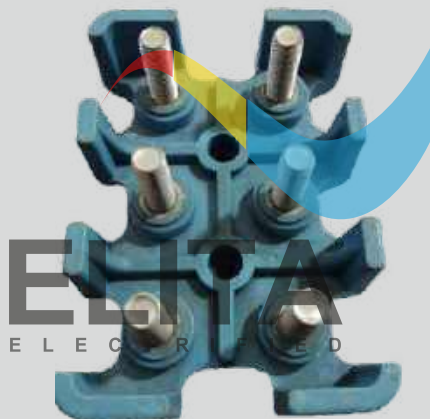

SUITABLE WEG 210

DRG NO.	L	B	E	D	H	T
EF-8199	210	146	65	10	105	M16



Point Motor Terminal Block
(6 F + 6 R) with cover

DRG NO.	L	B	E	D	H	T
EF-8121	100	45	86	6	35.5	M5

ALTERNATOR GENERATOR TERMINALS

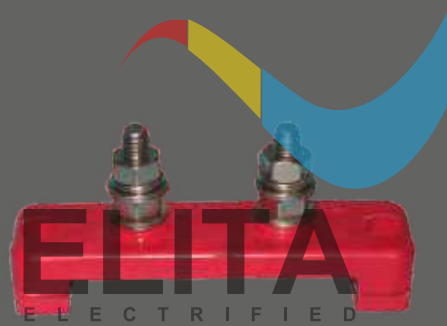

SUITABLE FOR
TYPE KR 7.5 X 15 KVA

DRG NO.	L	B	E	D	H	T
EF - 9001	110	30	107	8	60	M8



SUITABLE FOR
TYPE CR 25 KVA

DRG NO.	L	B	E	D	H	T
EF - 9002	130	60	70	2X7	45	M8

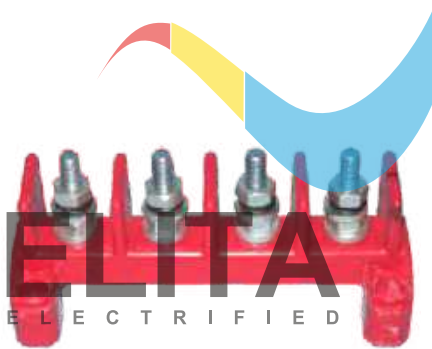

SUITABLE FOR
TYPE KG 82

DRG NO.	L	B	E	D	H	T
EF - 9003	185	40	175	10	100	M10

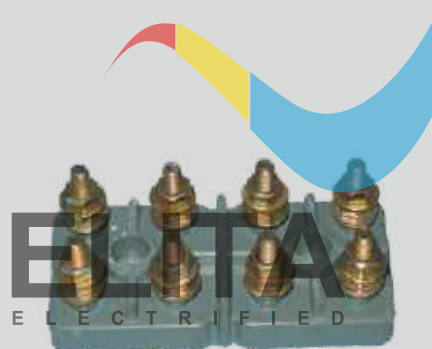

SUITABLE FOR
TYPE STAMFORD 15 KVA

DRG NO.	L	B	E	D	H	T
EF - 9004	104	47	55	7	42	M6

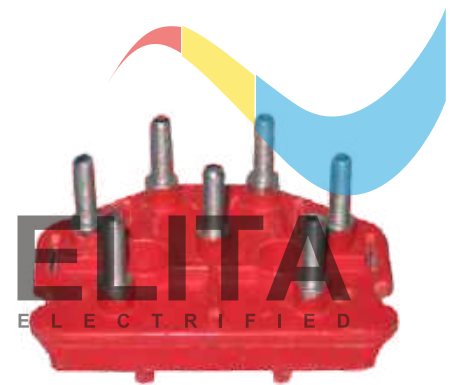

SUITABLE FOR
TYPE KG

DRG NO.	L	B	E	D	H	T
EF-9005	95	65	35	6	45	M6



SUITABLE FOR TYPE
TRIDENT 400 KVA

DRG NO.	L	B	E	D	H	T
EF - 9006	287	50	275	10	120	M12

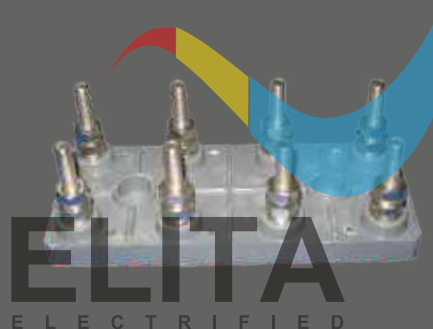

SUITABLE FOR TYPE
STAMFORD 125 KVA

DRG NO.	L	B	E	D	H	T
EF 9007	225	95	120	10	105	M10



SUITABLE FOR
TYPE STAMFORD 25 KVA

DRG NO.	L	B	E	D	H	T
EF - 9008	165	60	151	6	50	M6



SUITABLE FOR
TYPE STAMFORD 180 KVA

DRG NO.	L	B	E	D	H	T
EF-9009	291	90	271	8	80	M12

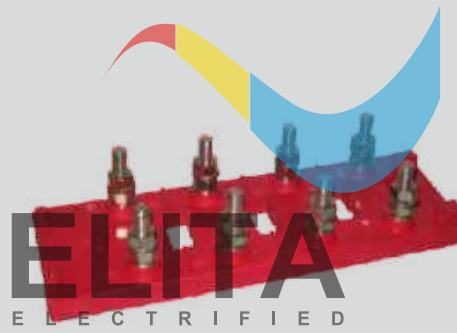

SUITABLE FOR
TYPE STAMFORD 360 KVA

DRG NO.	L	B	E	D	H	T
EF-9010	331	110	320	7	90	M12

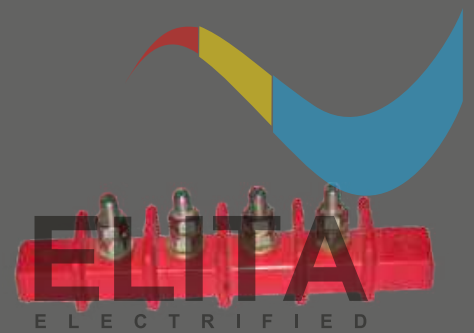

SUITABLE FOR TYPE
TRIDENT 20 KVA

DRG NO.	L	B	E	D	H	T
EF-9011	157	27	135	8	50	M8

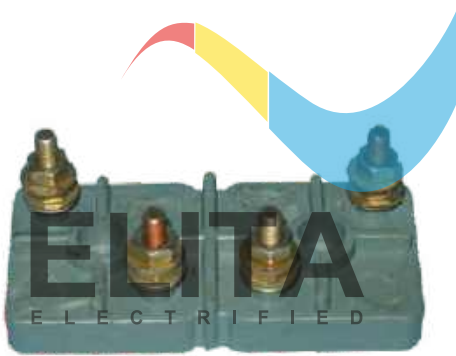

SUITABLE FOR
TYPE STAMFORD SINGLE
PHASE

DRG NO.	L	B	E	D	H	T
EF-9012	104	47	55	7	45	M6



SUITABLE FOR
TYPE LEROYSOMER 500 KVA

DRG NO.	L	B	E	D	H	T
EF-9014	313	60	292	8	100	M16

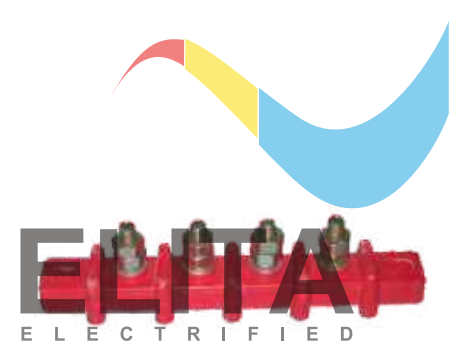

SUITABLE FOR TYPE
KR 120 KVA

DRG NO.	L	B	E	D	H	T
EF-9015	228	30	200	11X10	55	M10

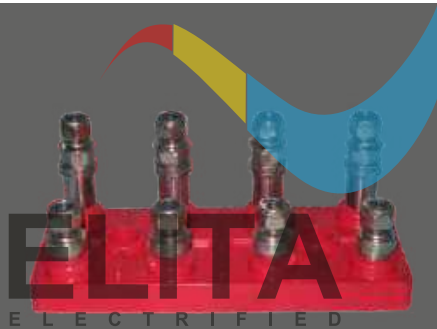

SUITABLE FOR TYPE
CR 120 KVA

DRG NO.	L	B	E	D	H	T
EF-9017	221	91	120	10	90	M12



SUITABLE FOR
TYPE CR 80 KVA OLD

DRG NO.	L	B	E	D	H	T
EF-9018	190	90	160	8	50	M8

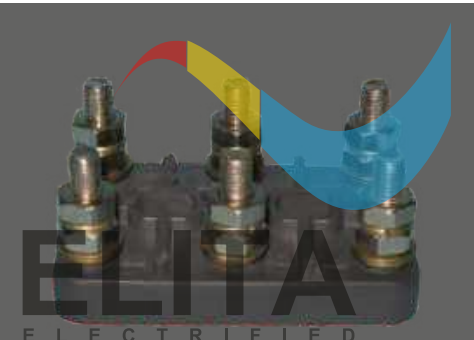

SUITABLE FOR
TYPE CR 50 KVA

DRG NO.	L	B	E	D	H	T
EF-9019	95	60	35	11X9	45	M8



SUITABLE FOR
TYPE TRIDENT 7.5 KVA

DRG NO.	L	B	E	D	H	T
EF-9020	115	21	110	8	50	M8

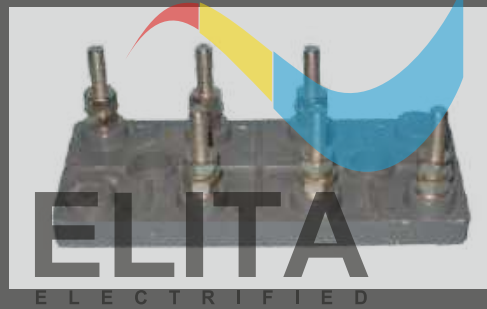

SUITABLE FOR
TYPE CR 120 KVA

DRG NO.	L	B	E	D	H	T
EF-9021	221	91	120	10	90	M12



SUITABLE FOR
TYPE CR 120 KVA

DRG NO.	L	B	E	D	H	T
EF-9022	221	91	120	10	90	M12

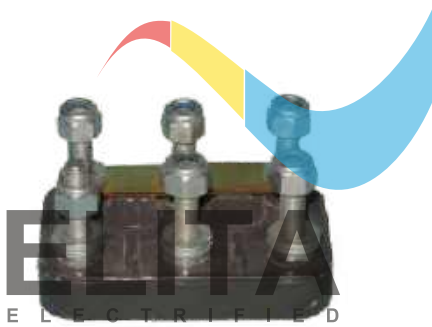

SUITABLE FOR
TYPE CR 80 KVA

DRG NO.	L	B	E	D	H	T
EF-9024	113	70	42	12X8	50	M10



SUITABLE FOR
TYPE KR 180 KVA

DRG NO.	L	B	E	D	H	T
EF-9025	430	35	335	14	60	M12

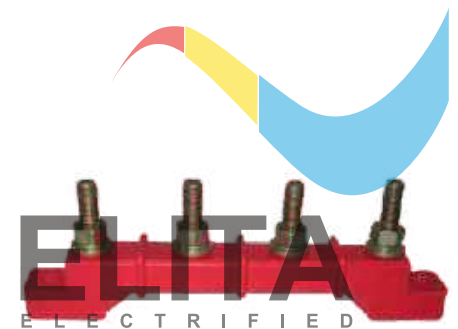

SUITABLE FOR
TYPE KR 160 KVA

DRG NO.	L	B	E	D	H	T
EF-9026	265	30	231	8	85	M10



SUITABLE FOR
TYPE KR 30 KVA

DRG NO.	L	B	E	D	H	T
EF-9027	19	25	160	8	55	M8

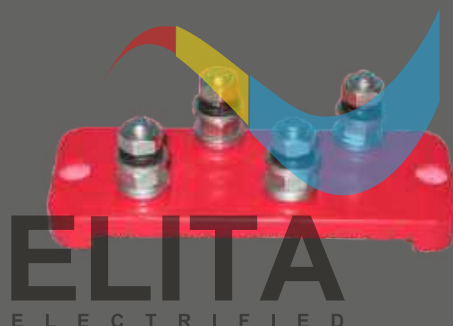

SUITABLE FOR
TYPE KR 30 -60 KVA

DRG NO.	L	B	E	D	H	T
EF-9029	135	50	125	8	70	M8



SUITABLE FOR
TYPE KR DC MOTOR

DRG NO.	L	B	E	D	H	T
EF-9000	110	25	90	8	55	M6XM8

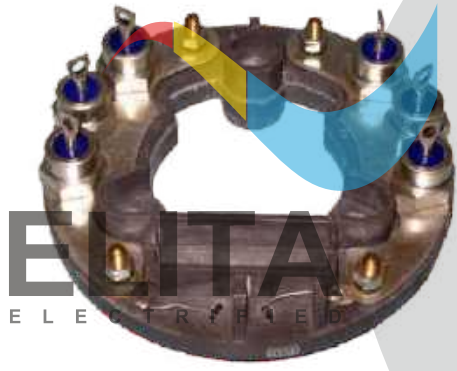

CROMPTON GREAVES 125 KVA



KIRLOSKAR GREEN 10 KVA

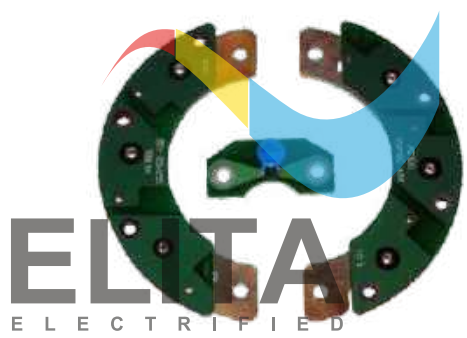

LEROY SOMERS 125 KVA

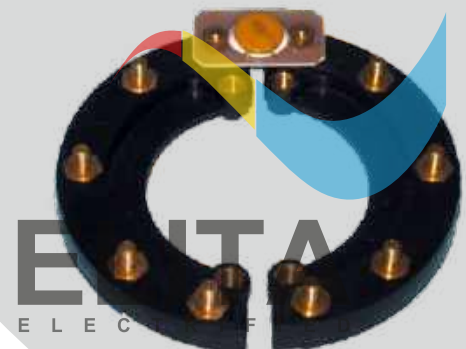

LEROY SOMERS 10 KVA



STAMFORD 360 KVA



KIRLOSKAR GREEN 125 KVA



KIRLOSKAR ELECTRIC 125 KVA



KIRLOSKAR GREEN 500 KVA



DRG NO.	L	B	E	D	H
EF-2001	22	22	-	4	13



DRG NO.	L	B	E	D	H
EF-2002	25	25	-	6	15



DRG NO.	L	B	E	D	H
EF-2003	58	29	50	5	19

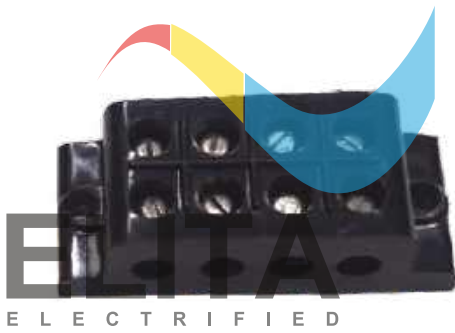

DRG NO.	L	B	E	D	H
EF-2004	70	29	60	5	19



DRG NO.	L	B	E	D	H
EF-2005	86	29	71	5	20



DRG NO.	L	B	E	D	H
EF-2006	94	30	84	5	23



DRG NO.	L	B	E	D	H
EF-2005 (OPEN)	105	45	95	5	23



EF 2008- NVC TYPE EL2



EF 2007- N.V.C SIEMENS
TYPE S-1



EF 2009- NVC JYT TYPE



EF 2010- NVC TYPE EK1



EF 2011- NVC MEI OLD TYPE



EF 2015- COPPER FINGURE
40HP (EC.GR)



EF 2014- COPPER FINGURE
60HP (EC.GR.)



EF 2013- COPPER FINGURE
80HP (EC.GR.)



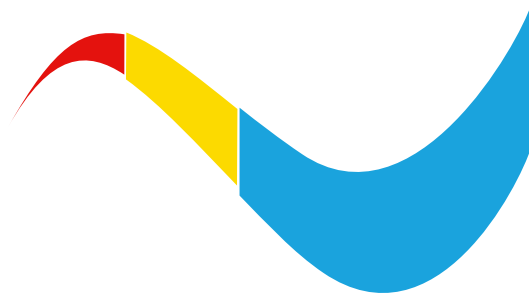

ELITA
E L E C T R I F I E D

📍 **SURAT**

Office

B-Wing, G-17 Silicon Shoppers, Opp. Satyanagar,
Nr. SMC South Zone Office,
Udhna Main Road, Udhna, 394210

📍 **AHMEDABAD**

Godown

4, Ground Floor Ramakrishna Chamber,
Sakar Bazar, Kalupur, 380002