

Hi-Fi[®]

electric

ULTIMATELY
SLIM





Hi-Fi[®]
electric



Hi-Class

Lee

Plate



CHROMO SWITCH



FLATINO SWITCH



SILVER SWITCH



E-CLASS SWITCH



HI-CLASS SWITCH



DINGO SWITCH

E-Class Switches With Spark Shield

Prod. Code	Description	₹		Std./Mst. Pkg.
		White	Grey/Black	
3061	10 AX. 1 Way Switch	57.00	65.00	20/1200
3062	10 AX. 2 Way Switch	83.00	94.00	20/1000
3063	10 AX. 1 Way Swi. with Indicator	86.00	94.00	20/1000
3065	10 AX. Bell Push	88.00	96.00	20/1000
3066	10 AX. Bell Push with Indicator	106.00	118.00	20/1000
3051	20 A. 1 Way Switch	95.00	107.00	20/1000
3053	20 A. 1 Way Switch with Indi.	114.00	130.00	20/1000
3052	20 A. 2 Way Switch	135.00	148.00	20/1000

Chromo Switches With Spark Shield

Prod. Code	Description	White	Grey/Black	Std./Mst. Pkg.
93001	10 AX. 1 Way Switch	76.00	84.00	20/1200
93002	10 AX. 2 Way Switch	114.00	125.00	20/1000
93003	10 AX. 1 Way Switch with Indicator	114.00	125.00	20/1000
93004	10 AX. Bell Push	114.00	125.00	20/1000
93005	10 AX. Bell Push with Indicator	133.00	146.00	20/1000
93020	20 A. 1 Way Switch	137.00	151.00	20/1000
93021	20 A. 1 Way Switch with Indicator	175.00	193.00	20/1000
93022	20 A. 2 Way Switch	169.00	186.00	20/1000

Flatino Switches With Spark Shield

Prod. Code	Description	White	Grey/Black	Std./Mst. Pkg.
81001	10 AX. 1 Way Switch	58.00	66.00	20/1200
81002	10 AX. 2 Way Switch	90.00	102.00	20/1200
81003	10 AX. 1 Way Switch with Indicator	92.00	102.00	20/1200
81004	10 AX. Bell Push	92.00	102.00	20/1200
81005	10 AX. Bell Push with Indicator	111.00	122.00	20/1200
81020	20 A. 1 Way Switch	99.00	110.00	20/1200
81021	20 A. 1 Way Switch with Indicator	121.00	137.00	20/1200
81022	20 A. 2 Way Switch	138.00	152.00	20/1200

Dingo Switches With Spark Shield

Prod. Code	Description	White	Grey/Black	Std./Mst. Pkg.
71001	10 AX. 1 Way Switch	64.00	70.00	20/1200
71002	10 AX. 2 Way Switch	96.00	106.00	20/1200
71003	10 AX. 1 Way Switch with Indicator	96.00	106.00	20/1200
71004	10 AX. Bell Push	97.00	107.00	20/1200
71005	10 AX. Bell Push with Indicator	113.00	124.00	20/1200
71020	20 A. 1 Way Switch	107.00	117.00	20/1200
71021	20 A. 1 Way Switch with Indicator	133.00	147.00	20/1200
71022	20 A. 2 Way Switch	147.00	161.00	20/1200

Silver Switches With Spark Shield

Prod. Code	Description	White	Grey/Black	Std./Mst. Pkg.
91001	10 AX. 1 Way Switch	84.00	92.00	20/1200
91002	10 AX. 2 Way Switch	132.00	145.00	20/1200
91003	10 AX. 1 Way Switch with Indicator	132.00	145.00	20/1200
91004	10 AX. Bell Push	138.00	152.00	20/1200
91005	10 AX. Bell Push with Indicator	161.00	177.00	20/1200
91020	20 A. 1 Way Switch	167.00	183.00	20/1200
91021	20 A. 1 Way Switch with Indicator	213.00	234.00	20/1200
91022	20 A. 2 Way Switch	214.00	235.00	20/1200

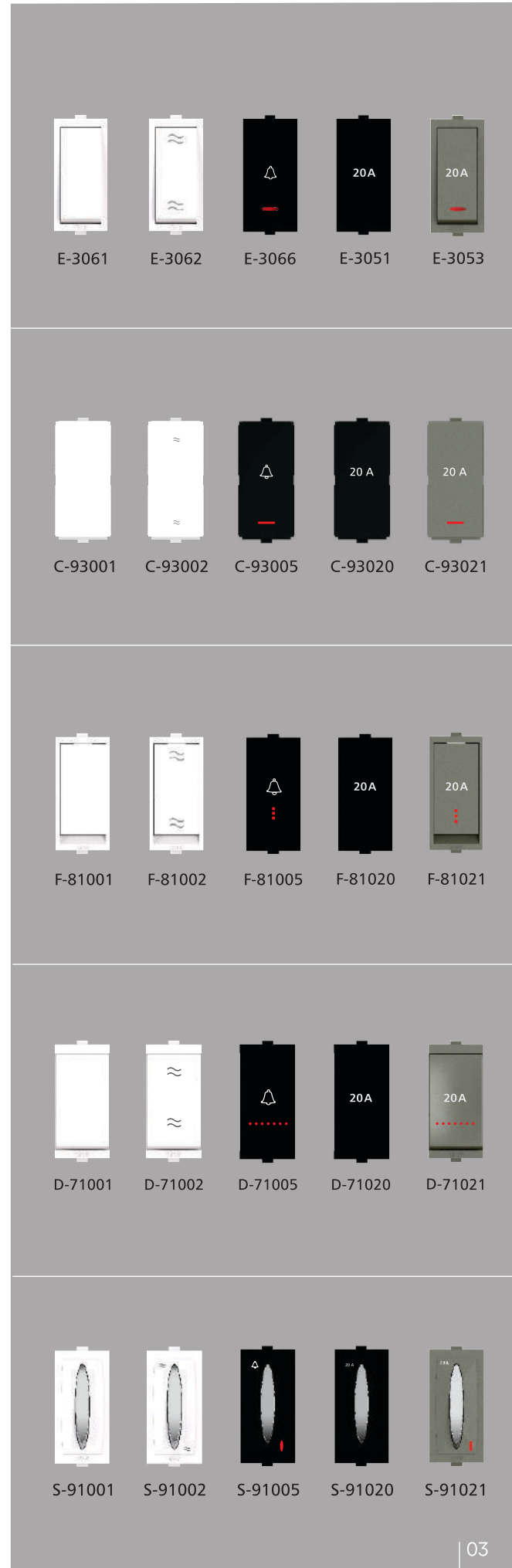

Hi - Class Switches

Prod. Code	Description	₹		Std./Mst. Pkg.
		White	Grey/Black	
3001	10 AX. 1 Way Switch	65.00	72.00	20/1200
3002	10 AX. 2 Way Switch	91.00	101.00	20/1000
3003	10 AX. 1 Way Switch with Indicator	91.00	101.00	20/1000
3005	10 AX. Bell Push	96.00	106.00	20/1000
3006	10 AX. Bell Push with Indicator	111.00	122.00	20/1000
3010	20 A. 1 Way Switch	120.00	132.00	20/1000
3012	20 A. 1 Way Switch with Indicator	139.00	153.00	20/1000
3011	20 A. 2 Way Switch	159.00	175.00	20/1000

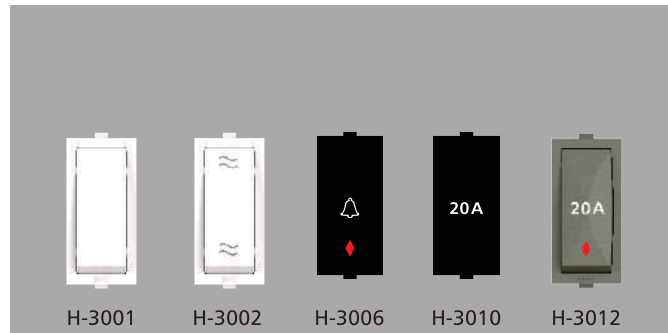

Chromo Switches (2M) Sumo Switch With Spark Shield

Prod. Code	Description			
92025	10 AX. 1 Way Swi. with Indicator	168.00	185.00	10/500
92026	10 AX. 2 Way Switch	168.00	185.00	10/500
92027	10 AX. Bell Push with Indicator	195.00	215.00	10/500
92028	20 A. 1 Way Swi. with Indicator	257.00	284.00	10/500
92029	20 A. 2 Way Switch	298.00	328.00	10/500

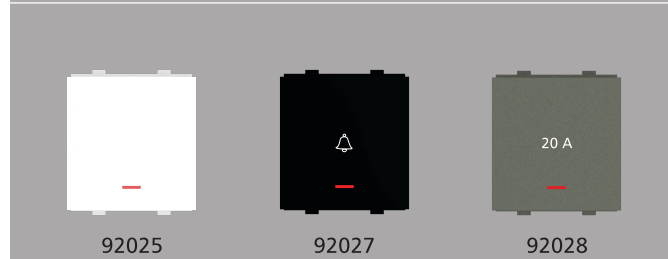

Hi - Class Switches (2M) Sumo Switch With Spark Shield

Prod. Code	Description			
3007	10 AX. 1 Way Switch with Indi.	108.00	119.00	10/500
3008	10 AX. 2 Way Switch	125.00	138.00	10/500
3009	10 AX. Bell Push with Indicator	131.00	144.00	10/500
30013	20 A. 1 Way Switch with Indi.	151.00	167.00	10/500
30014	20 A. 2 Way Switch	183.00	201.00	10/500

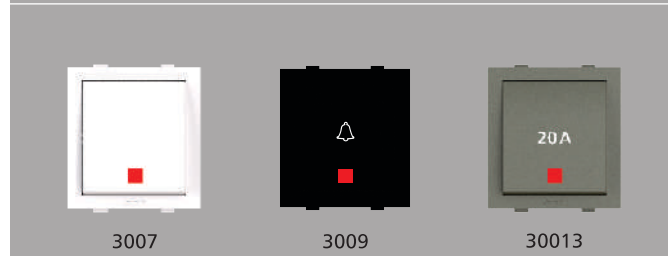

Flatino Switches (2M) Sumo Switch With Spark Shield

Prod. Code	Description			
81025	10 AX. 1 Way Swi. with Indicator	126.00	139.00	10/600
81026	10 AX. 2 Way Switch	126.00	139.00	10/600
81027	10 AX. Bell Push with Indicator	142.00	156.00	10/600
81028	20 A.1 Way Swi. with Indicator	165.00	181.00	10/600
81029	20 A.2 Way Switch	216.00	238.00	10/600

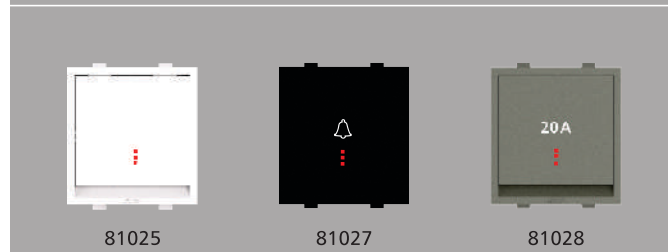

Silver Switches (2M) Sumo Switch With Spark Shield

Prod. Code	Description			
91025	10 AX. 1 Way Swi. with Indicator	185.00	204.00	10/600
91026	10 AX. 2 Way Switch	185.00	204.00	10/600
91027	10 AX. Bell Push with Indicator	225.00	248.00	10/600
91028	20 A. 1 Way Swi. with Indicator	297.00	327.00	10/600
91029	20 A. 2 Way Switch	329.00	362.00	10/600

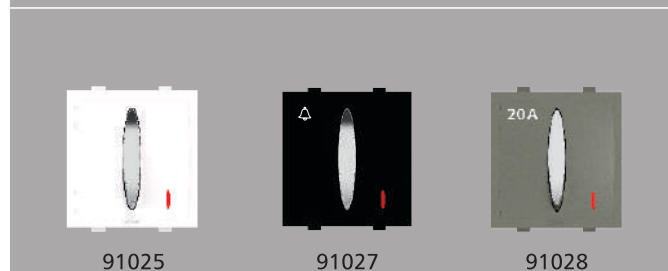

25A. Switch / 32A. D. P. Switch

Prod. Code	Description	₹		Std./Mst. Pkg.
		White	Grey/Black	
3054	E-Class 25A. S.P. 1 Way Switch with Indicator	185.00	204.00	20/1000
81030	Flatino 32A D.P. Sumo with Indi.	320.00	389.00	10/500
30016	Hi-Class 32A D.P. Sumo with Indi.	299.00	358.00	10/500



E-3054



81030



30016

Socket Outlet with Safety Shutter

Prod. Code	Description	White	Grey/Black	Std./Mst. Pkg.
30024	3 Pin Socket	66.00	72.00	20/960
30020	Multi Socket 16A. & 6A. Tested up to 20A. 250V.	158.00	173.00	10/500
30023	Heavy Duty Socket 16A. & 6A.	208.00	229.00	10/300

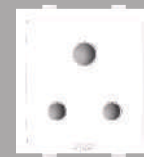

30024



30020



30023

EME Fan Regulator & Dimmers

Prod. Code	Description	White	Grey/Black	Std./Mst. Pkg.
30027	EME Swi. Type 4 Step Regu.100W	357.00	414.00	10/500
30026	EME Fan 5 Step Regulator with Indication 100W	412.00	466.00	10/500
30029	Mini Dimmer 450 W.	260.00	308.00	10/550
30030	Sumo Dimmer 450 W.	356.00	412.00	05/275
30031	EME Swi. Type 4 Step Star Regu. 100W	357.00	414.00	10/500
30032	EME Fan 5 Step Star Reg. with Indication 100W	412.00	466.00	10/500
30025	EME Fan 5 Step Reg. 120W	494.00	550.00	10/500



30027



30026



30029



30030



30031



30032



30025

Telephone / USB Charger / IT Products

Prod. Code	Description	White	Grey/Black	Std./Mst. Pkg.
30033	RJ 11 Tel. Jack Single with Shutter	96.00	105.00	20/1000
30034	RJ 11 Telephone Jack Double without Shutter	146.00	161.00	20/1000
30039	USB Charger-1M with LED Indi. & 1 USB Port, Input - 110V + 240V~ 50-60Hz, Output - 5V DC, 2A(2000mA)	757.00	833.00	10/500
30063	USB Charger-1M with Indi. A&C Type USB Port Input 90V To 240V AC, Fast Charger Output 18 watt 3.1A (3100mA)	1400.00	1540.00	10/500
30057	RJ 45 Modem Jack Swi. Type for Computer with Shutter	197.00	217.00	20/1000
30035	RJ 45 Modem Jack for Computer with Shutter	223.00	245.00	10/500
30036	RJ 45 Modem Jack for Lucent (AT & T) Cat-6	665.00	732.00	10/500



30033



30034



30039



30063



30057



30035



30036

SP / DP Modular MCB

Prod. Code	Description	₹		Std./Mst. Pkg.
		White	Grey/Black	
30043	Single Pole MCB (6A, 10A, 16A, 20A, 25A, 32A)	235.00	264.00	10/500
30044	Double Pole MCB (6A, 10A, 16A, 20A, 25A, 32A)	521.00	585.00	05/250
30060	Single Pole MCB HEAVY DUTY (6A, 10A, 16A, 20A, 25A, 32A)	253.00	293.00	10/500
30061	Double Pole MCB HEAVY DUTY (6A, 10A, 16A, 20A, 25A, 32A)	561.00	644.00	05/250

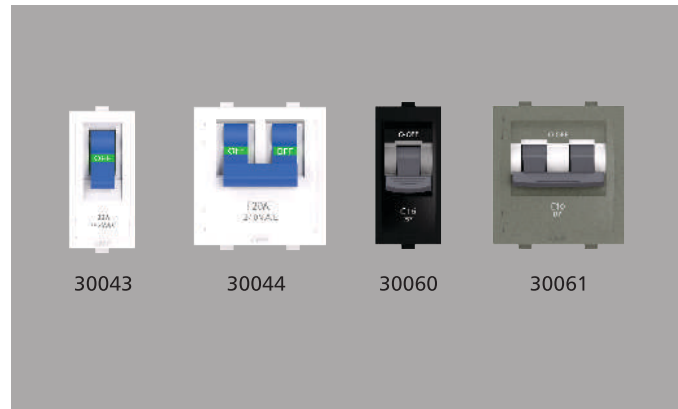

Other Products

Prod. Code	Description	White	Grey/Black	Std./Mst. Pkg.
30037	Kit-Kat Fuse Unit for 16A or 6A.	121.00	133.00	10/500
30038	Neon Indicator RED	79.00	88.00	20/1000
30015	Neon Indicator RED with TC	86.00	94.00	20/1000
30040	Cord Outlet	75.00	83.00	20/1000
30041	T. V. Single Outlet	88.00	97.00	20/1000
30042	Blank Plate Single	21.00	24.00	50/3500



Night Lamp / Mini Light / Foot Light

Prod. Code	Description	White	Grey/Black	Std./Mst. Pkg.
30047	Electronic Night Lamp (White, Warm White)	296.00	327.00	05/250
30056	Mini Light 2 Module (White, Warm White, Blue)	328.00	361.00	05/250
30059	Foot Light 3 Module (White, Warm White, Blue)	365.00	403.00	05/250
30062	Hi-Class Astro 3 Mod. LED Footlight (White, Warm White, Blue)	328.00	361.00	05/250
30071	1 Mod. LED Foot Light (White)	284.00	312.00	10/500
30070	3 Mod. LED Foot Light (Rectangle) (White)	365.00	403.00	05/250



Motor Starter / Mosquito Repellent / Buzzer

Prod. Code	Description	White	Grey/Black	Std./Mst. Pkg.
30022	Single Phase Motor Starter (7.5 / 10 / 16 / 20 / 25 Amp.)	524.00	577.00	05/250
30046	Bell Indicator	286.00	315.00	10/500
30048	Mosquito Repellent (Mat Required)	158.00	174.00	10/500
30051	Electronic Buzzer - 220V / 250V	306.00	337.00	05/250



Down Light / Foot Light

Prod. Code	Description	₹		Std./Mst. Pkg.
		White	Grey/Black	
30067	Hi-Class 4 Module Led Foot Light (Diffuse) (White)	578.00	635.00	01/100
30058	Down Light with LED (Without Conceal Metal Box) (White, Warm White, Blue)	636.00	700.00	01/100
30075	Hi-Class DELTA 4 Mod. LED Footlight (6 LED) (White, Warm White, Blue)	410.00	450.00	05/100
30069	Hi-Class UNO 4 Mod. LED Footlight (8 LED) (White, Warm White, Blue)	385.00	424.00	05/100



30067



30058



30075



30069

Hotel Room Services

Prod. Code	Description			
30052	32A. D. P. Mains Switch Operating with Key Tag	444.00	501.00	05/250
30053	Only Key Tag with Key Ring	78.00	85.00	25/1200



30052

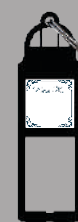

30053

Hotel Room Services Unit 3 Module

Prod. Code	Description			
30054	<p>Outside the Guest Room 3 Mod. Bell Push & 2 Indicators Which Indicates Do Not Disturb & Clean My Room</p> <p>Inside the Guest Room 2 Switches Marked with Do Not Disturb & Clean My Room</p>	531.00	584.00	01/-



H-30054



Energy Meter

Prod. Code	Description	M.R.P.	Std./Mst. Pkg.
919 101	Single Phase Electronic Energy Meter LCD Type Display	1089.00	01/48
919 102	Single Phase Electronic Energy Meter Counter Type Display	776.00	01/48
919 103	Single Phase Electronic Energy Meter LED Type Display	1485.00	01/48
919 301	Three Phase Electronic Energy Meter LCD Type Display	4015.00	01/20
919 302	Three Phase Electronic Energy Meter Counter Type Display	3410.00	01/20

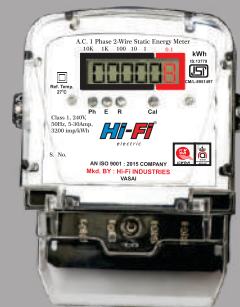

919 101

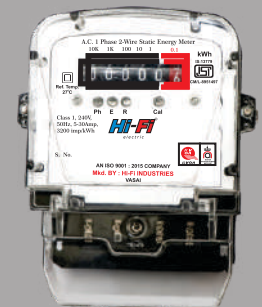

919 102



Hi-Fi[®]
electric

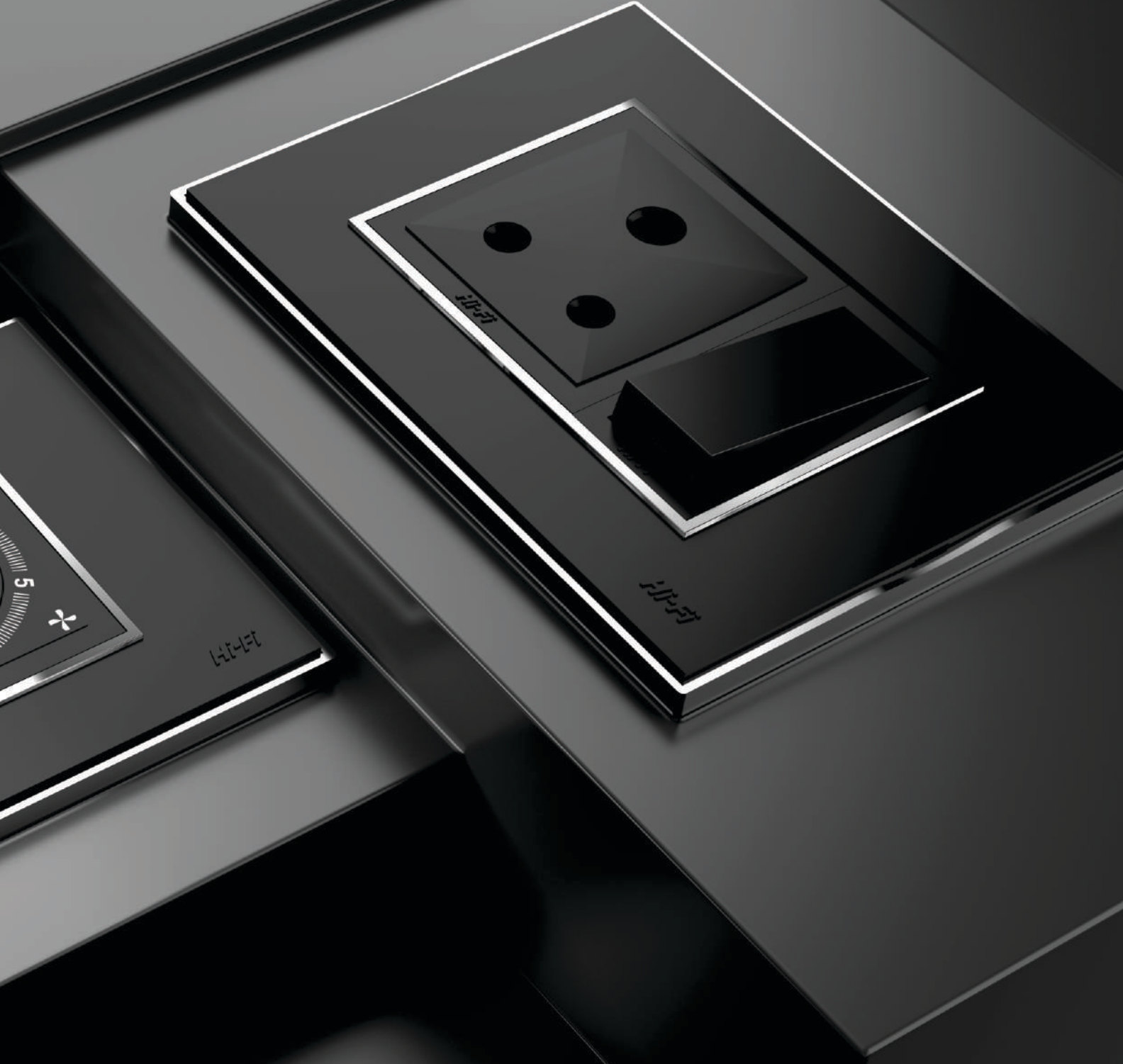

Hi-Class
CHROMO[™]
3S Plate

Hi-Class
CHROMOTM
3S Plate

Chromo 3S Matte Black Plate
With Chromo Switches

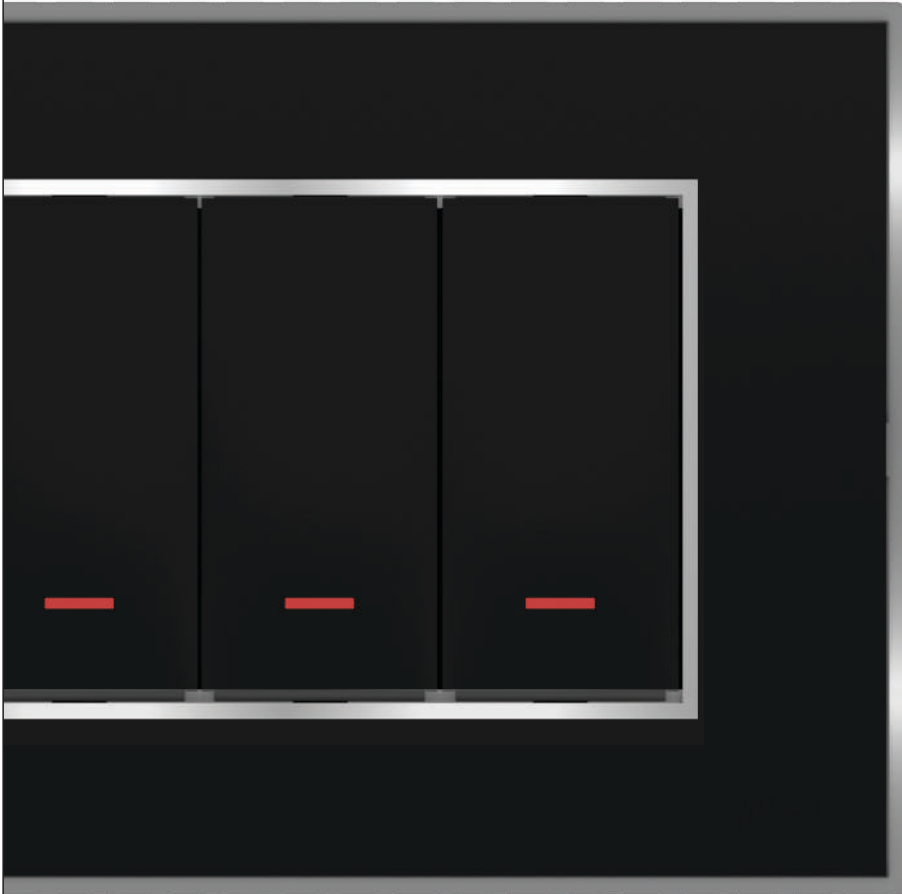

Hi-Class
CHROMOTM Double Plate Range
3S Plate

Suitable for Standard Sheet Metal, H.I.P.S. (PVC) & Surface Box

MODULES		1 M	2 M	3 M	4 M
COLOUR	PROD. CODE	74101	74102	74103	74104
WHITE	M.R.P.	100.00	100.00	138.00	164.00
METALLIC	M.R.P.	183.00	183.00	230.00	261.00
TEXTURE	M.R.P.	225.00	225.00	286.00	343.00
-	PKG	10	10	10	10
-	MASTER CARTON IN NOS	600	600	480	480

BASIC

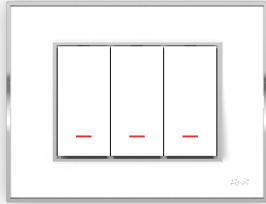

WHITE

METALLIC

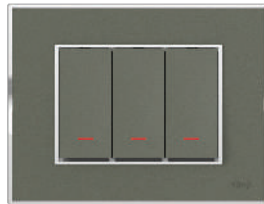

LEAD GREY



MATTE BLACK

TEXTURE



ASH WOOD

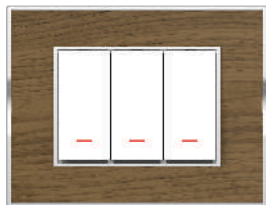

BROWN WALNUT

Range available from 1 Module to 21 Modules (Dimension in mm)

1 Module



95 x 90 mm
(3.5" x 3.5")

2 Module



95 x 90 mm
(3.5" x 3.5")

3 Module



118 x 90 mm
(4.5" x 3.5")

4 Module

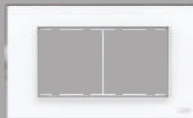

151 x 90 mm
(6" x 3.5")

6/7 Module

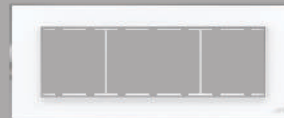

220 x 90 mm
(8.5" x 3.5")

8 Module (H)



262 x 90 mm
(10.5" x 3.5")

8 Module (V)



152 x 158 mm
(6" x 6")

12/14 Module

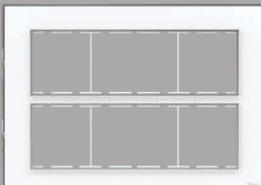

220 x 158 mm
(8.5" x 6")

16 Module

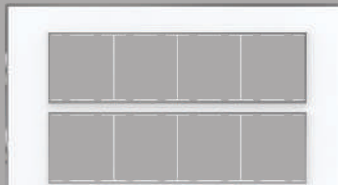

262 x 158 mm
(10.5" x 6")

18/21 Module



220 x 220 mm
(8.5" x 8.5")

6/7 M	8 M (H)	8 M (V)	12/14 M	16 M	18/21 M
74107	74108	74109	74114	74116	74121
213.00	268.00	268.00	335.00	410.00	446.00
337.00	438.00	438.00	561.00	719.00	756.00
466.00	582.00	582.00	700.00	861.00	940.00
10	10	05	05	05	05
300	320	210	180	180	150

Hi-Class

CHROMOTM
PLUS Plate

Chromo PLUS White Plate
With Flatino Switches

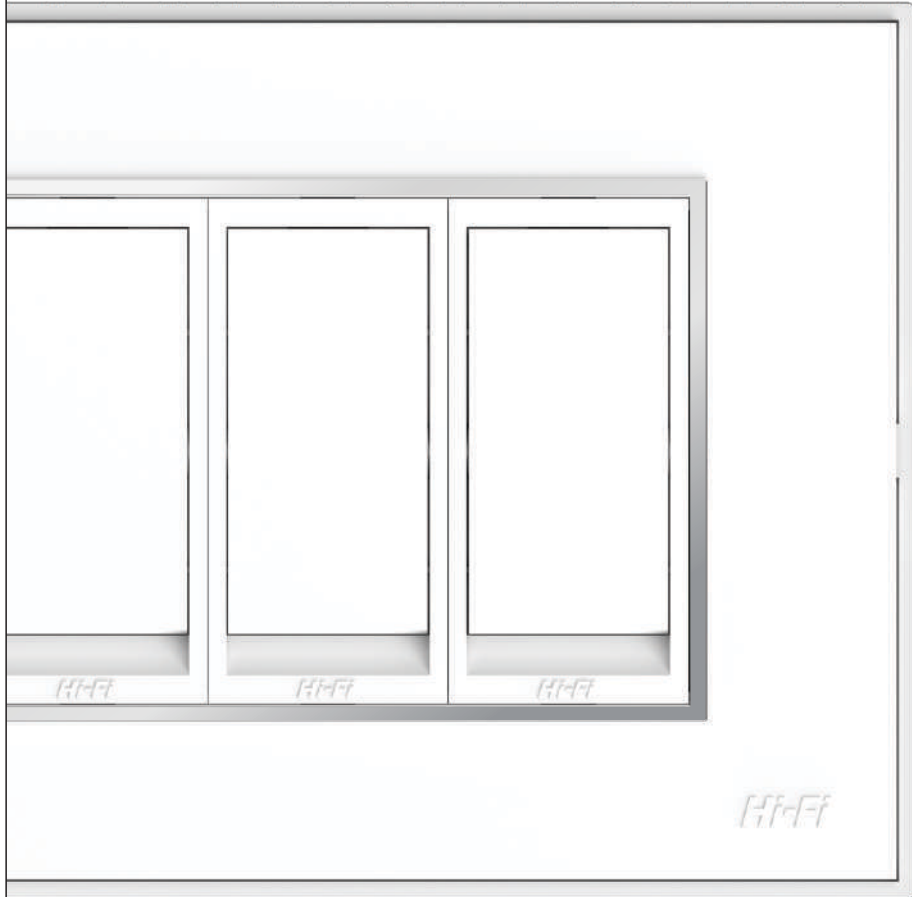

Hi-Class

CHROMOTM Double Plate Range
PLUS Plate

Suitable for Standard Sheet Metal, H.I.P.S. (PVC) & Surface Box

MODULES		1 M	2 M	3 M	4 M
COLOUR	PROD. CODE	74401	74402	74403	74404
WHITE	M.R.P.	75.00	75.00	101.00	114.00
-	PKG	10	10	10	10
-	MASTER CARTON IN NOS	600	600	480	480

BASIC



WHITE
(with Grey Switches)

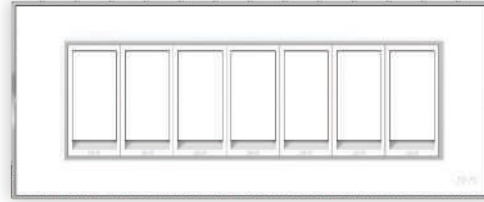

WHITE
(with White Switches)

Range available from 1 Module to 21 Modules (Dimension in mm)

1 Module



95 x 90 mm
(3.5' x 3.5')

2 Module



95 x 90 mm
(3.5' x 3.5')

3 Module



118 x 90 mm
(4.5' x 3.5')

4 Module



151 x 90 mm
(6' x 3.5')

6/7 Module



220 x 90 mm
(8.5' x 3.5')

8 Module (H)



262 x 90 mm
(10.5' x 3.5')

8 Module (V)



152 x 158 mm
(6' x 6')

12/14 Module

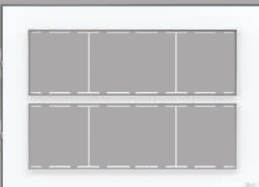

220 x 158 mm
(8.5' x 6')

16 Module

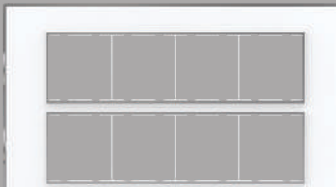

262 x 158 mm
(10.5' x 6')

18/21 Module



220 x 220 mm
(8.5' x 8.5')

6/7 M	8 M (H)	8 M (V)	12/14 M	16 M	18/21 M
74407	74408	74409	74414	74416	74421
175.00	235.00	235.00	283.00	352.00	364.00
10	10	05	05	05	05
300	320	210	180	180	150

Hi-Class
DingoTM Plate

Dingo Sap Wood Plate
With Indicator Switches



Hi-Class
DingoTM Double Plate Range

Suitable for Standard Sheet Metal, H.I.P.S. (PVC) & Surface Box

MODULES		1 M	2 M	3 M	4 M
COLOUR	PROD. CODE	71301	71302	71303	71304
WHITE	M.R.P.	90.00	90.00	113.00	148.00
METALLIC	M.R.P.	145.00	145.00	180.00	218.00
TEXTURE	M.R.P.	183.00	183.00	234.00	290.00
-	PKG	10	10	10	10
-	MASTER CARTON IN NOS	450	450	450	450

BASIC



WHITE



MERLOT RED

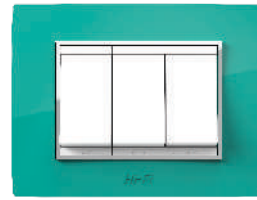

TURKISH BLUE



LEAD GREY

TEXTURE



MATTE BLACK



REAL WOOD



SAP WOOD

Range available from 1 Module to 21 Modules (Dimension in mm)

1 Module



95 x 90 mm
(3.5" x 3.5")

2 Module



95 x 90 mm
(3.5" x 3.5")

3 Module



118 x 90 mm
(4.5" x 3.5")

4 Module



152 x 90 mm
(6" x 3.5")

6/7 Module



220 x 90 mm
(8.5" x 3.5")

8 Module (H)



263 x 90 mm
(10.5" x 3.5")

8 Module (V)



152 x 158 mm
(6" x 6")

12/14 Module

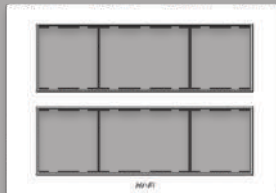

220 x 158 mm
(8.5" x 6")

16 Module

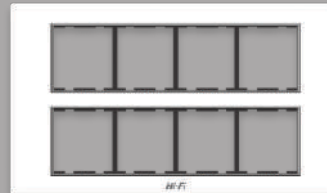

263 x 158 mm
(10.5" x 6")

18/21 Module

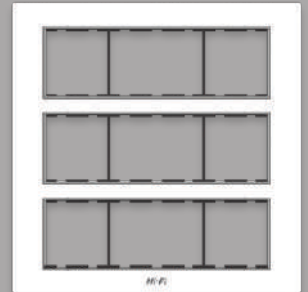

220 x 220 mm
(8.5" x 8.5")

6/7 M	8 M (V)	8 M (H)	12/14 M	16 M	18/21 M
71306	71307	71308	71312	71316	71318
213.00	261.00	261.00	308.00	426.00	444.00
310.00	397.00	397.00	480.00	641.00	673.00
433.00	542.00	542.00	621.00	791.00	851.00
10	05	10	05	05	05
300	180	300	150	150	120

Hi-Class

Dingo PlusTM
Plate

Dingo Plus White Plate
5 Step Regulator With Flatino Switches

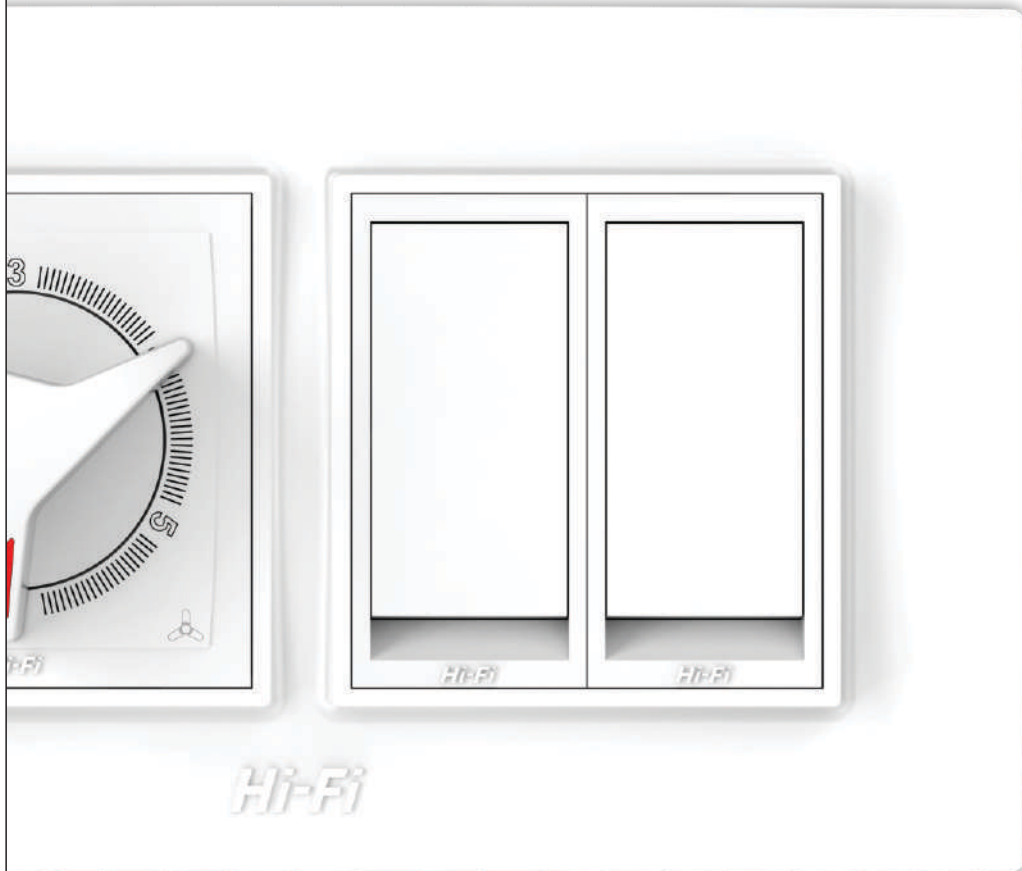

Hi-Class

Dingo PlusTM

Double Plate Range with Partition

Suitable for Standard Sheet Metal, H.I.P.S. (PVC) & Surface Box

MODULES		1 M	2 M	3 M
COLOUR	PROD. CODE	72101	72102	72103
WHITE	M.R.P.	87.00	87.00	110.00
-	PKG	10	10	10
-	MASTER CARTON IN NOS	450	450	450

BASIC



WHITE
(with Grey Switches)



WHITE
(with White Switches)

Range available from 1 Module to 18 Modules (Dimension in mm)

1 Module



95 x 90 mm
(3.5' x 3.5')

2 Module



95 x 90 mm
(3.5' x 3.5')

3 Module
(With Partition)



118 x 90 mm
(4.5' x 3.5')

4 Module
(With Partition)



152 x 90 mm
(6' x 3.5')

6 Module
(With Partition)



220 x 90 mm
(8.5' x 3.5')

8 Module (V)
(With Partition)



152 x 158 mm
(6' x 6')

8 Module (H)
(With Partition)



263 x 90 mm
(10.5' x 3.5')

12 Module (H)
(With Partition)

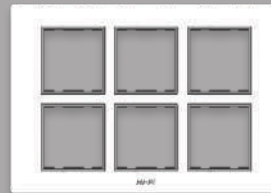

220 x 158 mm
(8.5' x 6')

18 Module
(With Partition)

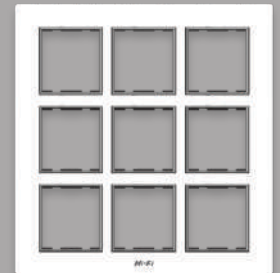

220 x 220 mm
(8.5' x 8.5')

4 M	6 M	8 M (V)	8 M (H)	12 M	18 M
72104	72106	72107	72108	72112	72118
131.00	177.00	219.00	219.00	300.00	392.00
10	10	05	10	05	05
450	300	180	300	150	120

Hi-Class

SilverlineTM
Plate

Silverline White Plate
With E-Class Switches



Hi-Class

SilverlineTM Double Plate Range

Suitable for Standard Sheet Metal, H.I.P.S. (PVC) & Surface Box

MODULES		1 M	2 M	3 M	4 M
COLOUR	PROD. CODE	5001	5002	5003	5004
WHITE / IVORY	M.R.P.	75.00	75.00	101.00	114.00
METALLIC	M.R.P.	137.00	137.00	169.00	184.00
TEXTURE	M.R.P.	167.00	167.00	209.00	241.00
-	PKG	10	10	10	10
-	MASTER CARTON IN NOS	600	600	480	480

BASIC



WHITE



AQUA BLUE



CHERRY RED

METALLIC



LEAD GREY

TEXTURE



MATTE BLACK



BRUSH WOOD



BRICK WOOD



CAFÉ WOOD

Range available from 1 Module to 18 Modules (Dimension in mm)

1 Module



95 x 90 mm
(3.5' x 3.5')

2 Module



95 x 90 mm
(3.5' x 3.5')

3 Module



118 x 90 mm
(4.5' x 3.5')

4 Module

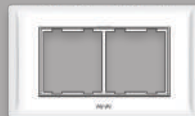

151 x 90 mm
(6' x 3.5')

6 Module



220 x 90 mm
(8.5' x 3.5')

8 Module (H)



262 x 90 mm
(10.5' x 3.5')

8 Module (V)



152 x 158 mm
(6' x 6')

12 Module



220 x 158 mm
(8.5' x 6')

16 Module



158 x 262 mm
(6' x 10.5')

18 Module



220 x 220 mm
(8.5' x 8.5')

6 M	8 M (V)	8 M (H)	12 M	16 M	18 M
5005	5006	5007	5008	5009	5010
175.00	235.00	235.00	283.00	359.00	371.00
269.00	368.00	368.00	453.00	573.00	600.00
366.00	481.00	481.00	555.00	678.00	731.00
10	05	10	05	05	05
300	210	320	180	180	150

Hi-Class
LeeTM
Plate

Lee White Plate
With Silver Switches



Hi-Class
LeeTM Double Plate Range

Suitable for Standard Sheet Metal, H.I.P.S. (PVC) & Surface Box

MODULES		1 M	2 M	3 M	4 M
COLOUR	PROD. CODE	LE0101	LE0202	LE0303	LE0404
WHITE	M.R.P.	70.00	70.00	90.00	106.00
METALLIC	M.R.P.	125.00	125.00	157.00	177.00
-	PKG	10	10	10	10
-	MASTER CARTON IN NOS	450	450	450	450

BASIC



WHITE

METALLIC



LEAD GREY



MATTE BLACK

Range available from 1 Module to 18 Modules (Dimension in mm)

1 Module



94 x 90 mm
(3.5" x 3.5")

2 Module



94 x 90 mm
(3.5" x 3.5")

3 Module



118 x 90 mm
(4.5" x 3.5")

4 Module



150 x 90 mm
(6" x 3.5")

6 Module



220 x 90 mm
(8.5" x 3.5")

8 Module (H)



262 x 90 mm
(10.5" x 3.5")

8 Module (V)



150 x 158 mm
(6" x 6")

12 Module



220 x 158 mm
(8.5" x 6")

16 Module

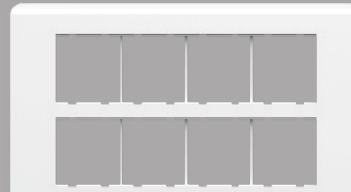

262 x 158 mm
(10.5" x 6")

18 Module



220 x 220 mm
(8.5" x 8.5")

6 M	8 M (H)	8 M (V)	12 M	16 M	18 M
LE0605	LE0806	LE0807	LE1208	LE1609	LE1810
151.00	189.00	189.00	230.00	281.00	311.00
249.00	324.00	324.00	409.00	498.00	553.00
10	10	05	05	05	05
300	300	180	150	150	120

Hi-Class
Hi-ClassTM
Plate

Hi-Class Teak Wood Plate
with Hi-Class Switches

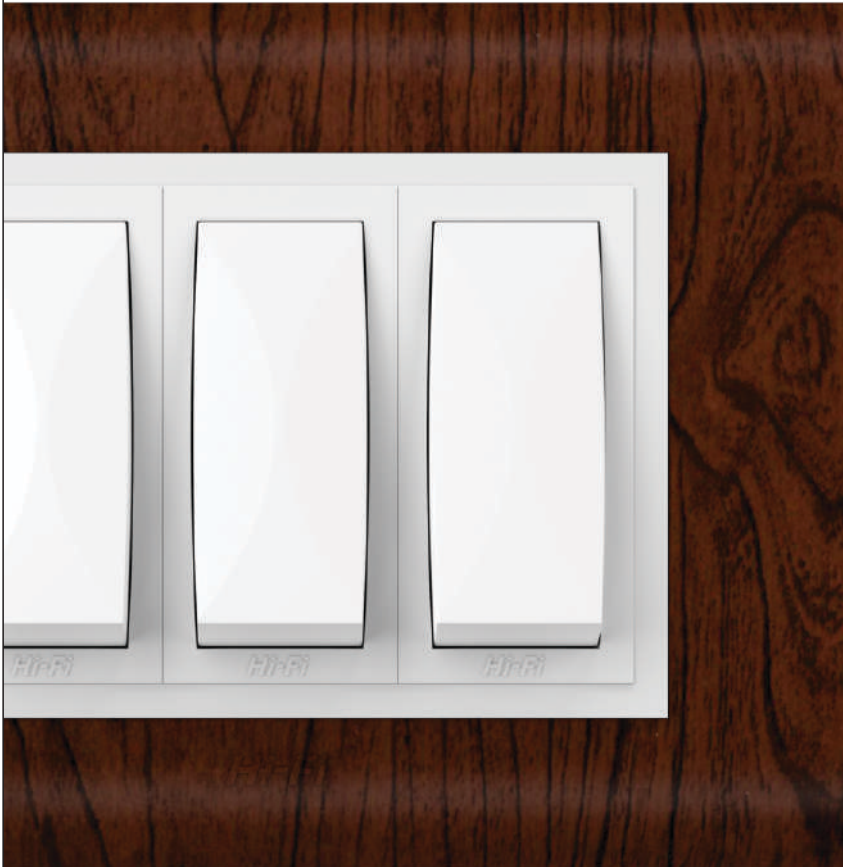

Hi-Class
Hi-ClassTM Double Plate Range

Suitable for Standard Sheet Metal, H.I.P.S. (PVC) & Surface Box

MODULES		1 M	2 M	3 M	4 M
COLOUR	PROD. CODE	HC 4001	HC 4002	HC 4003	HC 4004
WHITE	M.R.P.	67.00	67.00	85.00	101.00
TEXTURE	M.R.P.	151.00	151.00	193.00	229.00
-	PKG	10	10	10	10
-	MASTER CARTON IN NOS	600	600	640	520

BASIC



WHITE

TEXTURE



TEAK WOOD



SAL WOOD

Range available from 1 Module to 18 Modules (Dimension in mm)

1 Module



95 x 90 mm
(3.5' x 3.5')

2 Module



95 x 90 mm
(3.5' x 3.5')

3 Module



118 x 90 mm
(4.5' x 3.5')

4 Module



151 x 90 mm
(6' x 3.5')

6 Module



220 x 90 mm
(8.5' x 3.5')

8 Module (H)



262 x 90 mm
(10.5' x 3.5')

8 Module (V)

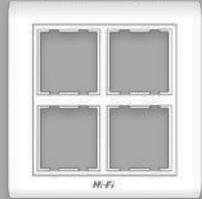

152 x 158 mm
(6' x 6')

12 Module



220 x 158 mm
(8.5' x 6')

16 Module



260 x 158 mm
(10.5' x 6')

18 Module

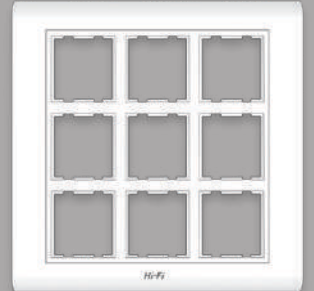

220 x 220 mm
(8.5' x 8.5')

6 M	8 M (V)	8 M (H)	12 M	16 M	18 M
HC 4005	HC 4006	HC 4007	HC 4008	HC 4010	HC 4009
144.00	180.00	180.00	219.00	261.00	289.00
339.00	432.00	432.00	502.00	570.00	651.00
10	05	10	05	05	05
400	210	420	240	210	160

Hi-ClassTM
PC Plate

PC Metallic Copper Plate
With E-Class Switches

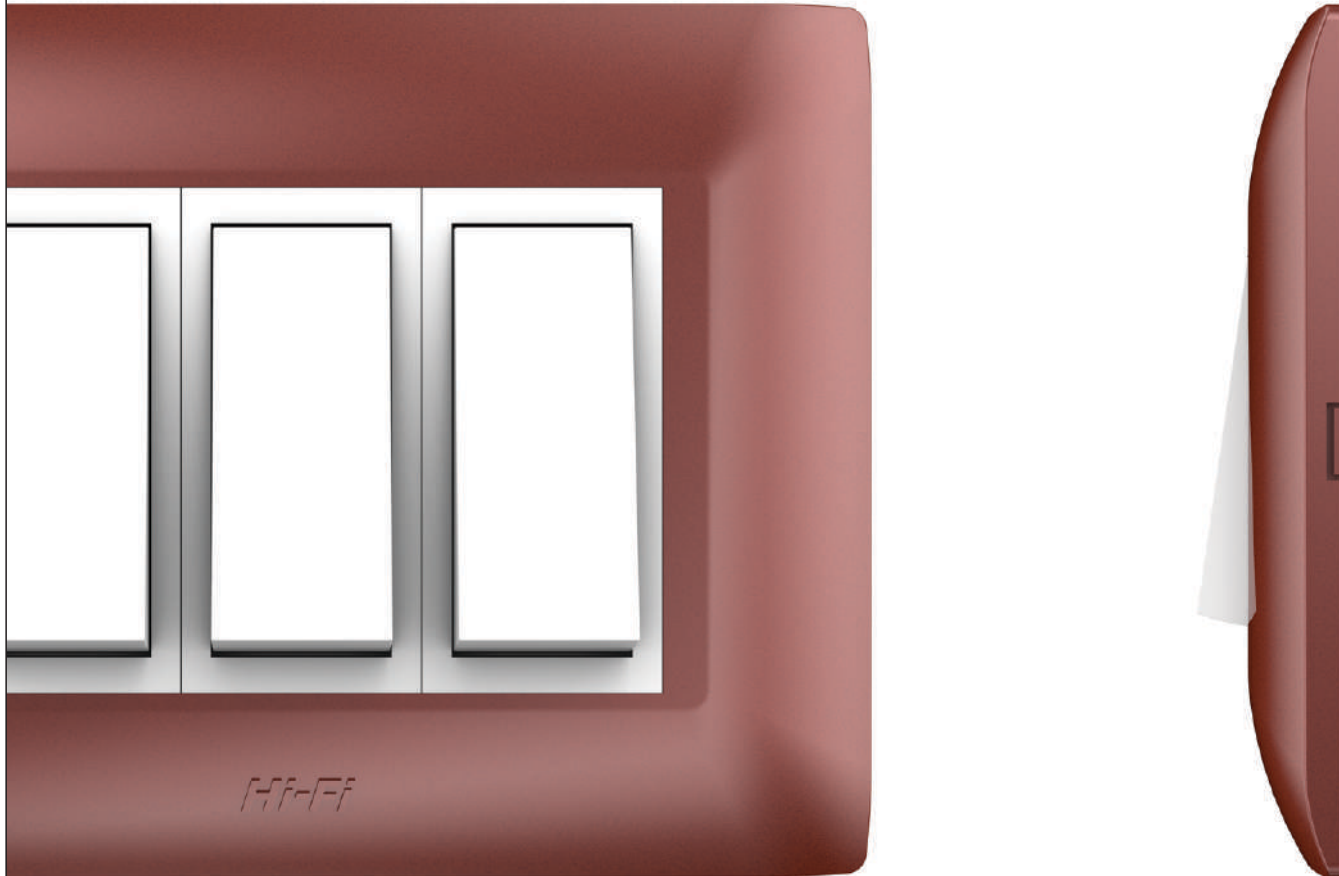

Hi-ClassTM
PC Double Plate Range

Suitable for Standard Sheet Metal, H.I.P.S. (PVC) & Surface Box

MODULES		1 M	2 M	3 M	4 M
COLOUR	PROD. CODE	PC 4011	PC 4012	PC 4013	PC 4014
WHITE	M.R.P.	67.00	67.00	85.00	101.00
METALLIC	M.R.P.	122.00	122.00	152.00	172.00
-	PKG	10	10	10	10
-	MASTER CARTON IN NOS	600	600	640	520

BASIC

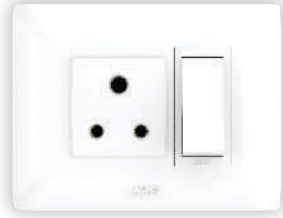

WHITE

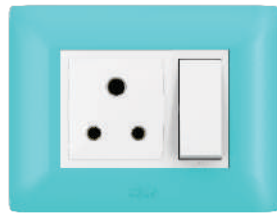

AQUA BLUE

METALLIC

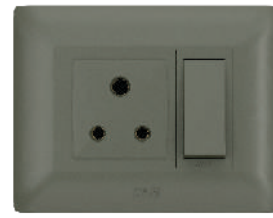

LEAD GREY

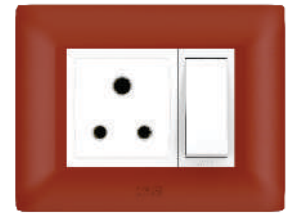

METALLIC COPPER



ROYAL SILVER

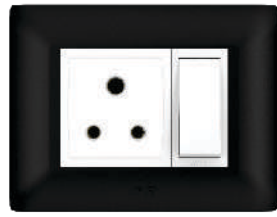

METALLIC BLACK

Range available from 1 Module to 18 Modules (Dimension in mm)

1 Module



95 x 90 mm
(3.5' x 3.5')

2 Module



95 x 90 mm
(3.5' x 3.5')

3 Module



118 x 90 mm
(4.5' x 3.5')

4 Module



151 x 90 mm
(6' x 3.5')

6 Module



220 x 90 mm
(8.5' x 3.5')

8 Module (H)



262 x 90 mm
(10.5' x 3.5')

8 Module (V)



158 x 158 mm
(6' x 6')

12 Module

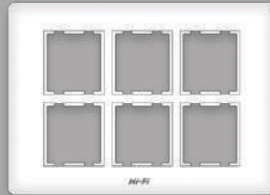

220 x 158 mm
(8.5' x 6')

16 Module



262 x 158 mm
(10.5' x 6')

18 Module

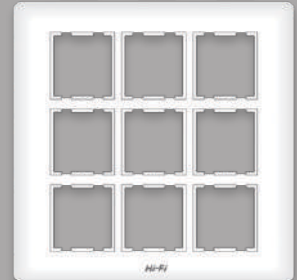

220 x 220 mm
(8.5' x 8.5')

6 M	8 M (V)	8 M (H)	12 M	16 M	18 M
PC 4015	PC 4016	PC 4018	PC 4019	PC 4020	PC 4021
144.00	180.00	180.00	219.00	261.00	289.00
243.00	315.00	315.00	398.00	467.00	519.00
10	05	10	05	05	05
400	210	420	240	210	160

Hi-Class

Flatino WoodTM
Plate

Flatino Wood Plate
With Flatino Switches



Hi-Class

Flatino WoodTM Double Plate Range

Suitable for Wooden Box

MODULES		1 M	2 M	3 M	4 M	6 M	8 M(H)
COLOUR	PROD. CODE	73101	73102	73103	73104	73106	73108
WHITE / IVORY	M.R.P.	113.00	113.00	122.00	151.00	197.00	247.00
METALLIC	M.R.P.	178.00	178.00	187.00	238.00	304.00	384.00
TEXTURE	M.R.P.	206.00	206.00	213.00	258.00	335.00	413.00
-	PKG	10	10	10	10	10	10
-	MASTER CARTON IN NOS	480	480	460	480	360	280

BASIC



WHITE



AQUA BLUE



CHERRY RED

METALLIC



LEAD GREY

TEXTURE

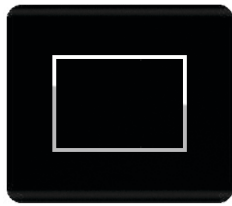

MATTE BLACK



WALNUT



MAPLE WOOD

Range available from 1 Module to 24 Modules (Dimension in mm)

1 Module



115 x 115 mm
(4.5" x 4.5")

2 Module



115 x 115 mm
(4.5" x 4.5")

3 Module



130 x 115 mm
(5" x 4.5")

4 Module



180 x 115 mm
(7" x 4.5")

6 Module



220 x 115 mm
(8.5" x 4.5")

8 Module (H)



270 x 115 mm
(10.5" x 4.5")

10 Module (H)



316 x 115 mm
(12.5" x 4.5")

12 Module (H)



392 x 115 mm
(15.5" x 4.5")

12 Module (S)



220 x 180 mm
(8.5" x 7")

12 Module (V)



165 x 217 mm
(6.5" x 8.5")

16 Module (S)



270 x 181 mm
(10.5" x 7")

16 Module (Big)



268 x 216 mm
(10.5" x 8.5")

18 Module (V)

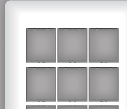

216 x 267 mm
(8.5" x 10.5")

18 Module (H)

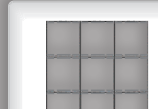

276 x 228 mm
(11" x 9")

20 Module

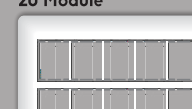

316 x 181 mm
(12.5" x 7")

24 Module



319 x 220 mm
(12.5" x 8.5")

10 M(H)	12 M(H)	12 M(S)	12 M(V)	16 M(S)	16 M(B)	18 M(V)	18 M(H)	20 M	24 M
73110	73112 H	73112	73112 V	73116 S	73116 B	73118 V	73118 H	73120	73124
275.00	373.00	308.00	342.00	394.00	469.00	514.00	514.00	488.00	590.00
416.00	548.00	474.00	508.00	562.00	678.00	724.00	724.00	688.00	786.00
448.00	590.00	503.00	551.00	602.00	725.00	779.00	779.00	740.00	873.00
10	10	10	10	10	10	10	10	10	10
240	180	280	280	200	160	120	120	200	140

Hi-Class

S-woodTM
Plate

S-Wood Dark Coffee Wood Plate
with 3 Pin Socket and Flatino Switches



Hi-ClassTM
S-wood Double Plate Range

Suitable for Wooden Box

MODULES		1 M	2 M	3 M	4 M	6 M	8 M(H)
COLOUR	PROD. CODE	SW 01	SW 02	SW 03	SW 04	SW 06	SW 08
WHITE / IVORY	M.R.P.	107.00	107.00	115.00	144.00	186.00	235.00
METALLIC	M.R.P.	163.00	163.00	169.00	214.00	274.00	347.00
TEXTURE	M.R.P.	180.00	180.00	190.00	232.00	288.00	358.00
-	PKG	10	10	10	10	10	10
-	MASTER CARTON IN NOS	450	450	450	360	320	240

BASIC



WHITE



IVORY

METALLIC



LEAD GREY



MATTE BLACK

TEXTURE



ROYAL WOOD



KHADI WOOD



DARK COFFEE WOOD



TEAK WOOD

Range available from 1 Module to 24 Modules (Dimension in mm)

1 Module



114 x 114 mm
(4.5" x 4.5")

2 Module



114 x 114 mm
(4.5" x 4.5")

3 Module

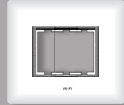

130 x 114 mm
(5" x 4.5")

4 Module

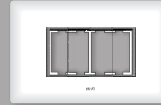

180 x 114 mm
(7" x 4.5")

6 Module



220 x 114 mm
(8.5" x 4.5")

8 Module (H)

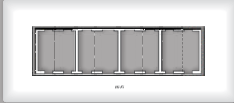

270 x 114 mm
(10.5" x 4.5")

10 Module (H)



317 x 114 mm
(12.5" x 4.5")

12 Module (H)



393 x 114 mm
(15.5" x 4.5")

12 Module (S)



220 x 180 mm
(8.5" x 7")

16 Module (S)



270 x 180 mm
(10.5" x 7")

16 Module (Big)



266 x 116 mm
(10.5" x 8.5")

18 Module (H)

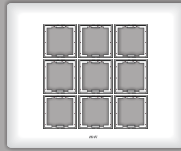

279 x 228 mm
(11" x 9")

18 Module (V)



216 x 267 mm
(8.5" x 10.5")

20 Module

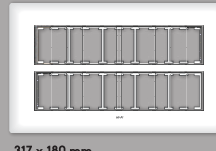

317 x 180 mm
(12.5" x 7")

24 Module



317 x 222 mm
(12.5" x 8.5")

10 M(H)	12 M(H)	12 M(S)	16 M(S)	16 M(B)	18 M(V)	18 M(H)	20 M	24 M
SW 10	SW 12 H	SW 12 S	SW 16 S	SW 16 B	SW 18 V	SW 18 B	SW 20	SW 24
262.00	348.00	293.00	374.00	449.00	489.00	489.00	465.00	551.00
376.00	497.00	430.00	528.00	626.00	663.00	663.00	629.00	720.00
388.00	511.00	444.00	541.00	641.00	681.00	681.00	648.00	764.00
10	10	05	05	05	05	05	05	05
200	150	180	140	140	100	100	100	90

Hi-Class

e-woodTM
Plate

E-Wood Ivory Plate with
3 Pin Socket and E-Class Switches



Hi-Class

e-woodTM Double Plate Range

Suitable for Wooden Box

MODULES		1 M	2 M	3 M	4 M	6 M	8 M(H)
COLOUR	PROD. CODE	ew 01	ew 02	ew 03	ew 04	ew 06	ew 08
WHITE / IVORY	M.R.P.	124.00	124.00	127.00	163.00	202.00	260.00
METALLIC	M.R.P.	184.00	184.00	187.00	242.00	298.00	384.00
TEXTURE	M.R.P.	206.00	206.00	210.00	260.00	315.00	395.00
-	PKG	10	10	10	10	10	10
-	MASTER CARTON IN NOS	390	390	390	400	320	240

BASIC



WHITE



IVORY

METALLIC



LEAD GREY



MATTE BLACK

TEXTURE



ROYAL SILVER



SARTIN DARK WOOD



TEAK WOOD

Range available from 1 Module to 24 Modules (Dimension in mm)

1 Module



128 x 128 mm
(5" x 5")

2 Module



128 x 128 mm
(5" x 5")

3 Module



128 x 128 mm
(5" x 5")

4 Module



178 x 128 mm
(7" x 5")

6 Module



224 x 128 mm
(9" x 5")

8 Module (H)



276 x 128 mm
(11" x 5")

10 Module (H)



317 x 128 mm
(12.5" x 5")

12 Module (H)



388 x 128 mm
(15" x 5")

12 Module (S)



225 x 185 mm
(9" x 7")

12 Module (Big)



216 x 216 mm
(8.5" x 8.5")

12 Module (V)



165 x 216 mm
(6.5" x 8.5")

16 Module (S)



278 x 185 mm
(11" x 7")

16 Module (Big)



266 x 216 mm
(10.5" x 8.5")

18 Module (V)



226 x 278 mm
(9" x 11")

20 Module



317 x 185 mm
(12.5" x 7")

24 Module



317 x 241 mm
(12.5" x 9.5")

10 M(H)	12 M(H)	12 M(V)	12 M(S)	12 M(B)	16 M(S)	16 M(B)	18 M(V)	20 M	24 M
ew 10	ew 12 H	ew 12 V	ew 12 S	ew 12 B	ew 16 S	ew 16 B	ew 18 V	ew 20	ew 24
294.00	368.00	334.00	317.00	364.00	399.00	462.00	463.00	471.00	550.00
424.00	526.00	492.00	470.00	510.00	565.00	643.00	623.00	639.00	718.00
437.00	541.00	510.00	486.00	524.00	578.00	657.00	642.00	658.00	763.00
10	10	05	05	05	05	05	05	05	05
200	160	240	210	180	140	150	140	120	100



Single PLATE RANGE

Range available from 1 Module to 18 Modules

MODULES		1 M	2 M	3 M	4 M	6 M	8 M (V)	8 M (H)	12 M	16 M	18 M
COLOUR	PROD. CODE	SP 01	SP 02	SP 03	SP 04	SP 06	SP 08 V	SP 08 H	SP 12	SP 16	SP 18
WHITE	M.R.P.	47.00	47.00	63.00	71.00	106.00	130.00	130.00	169.00	187.00	230.00
-	PKG.	10	10	10	10	10	05	10	05	05	05
-	MASTER CARTON IN NOS	1000	1000	640	520	400	210	420	240	210	160

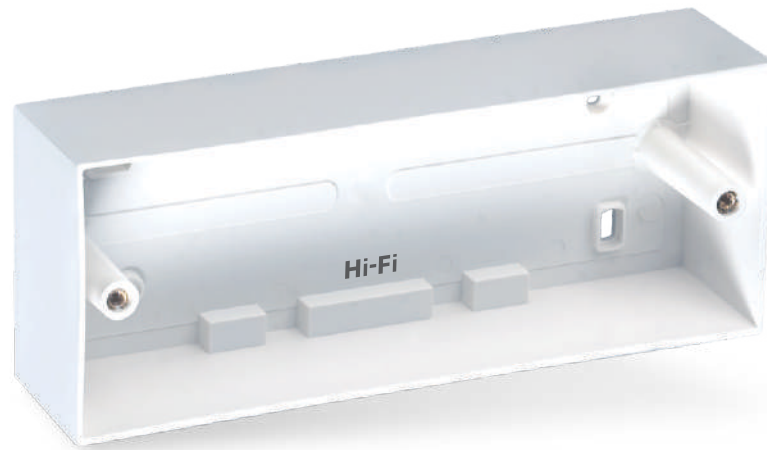

Hi-ClassTM PLASTIC SURFACE BOXES

Range available from 1 Module to 18 Modules

MODULES		1-2 M	3 M	4 M	6 M	8 M (V)	8 M (H)	12 M	18 M
COLOUR	PROD. CODE	HS 1-2	HS 03	HS 04	HS 06	HS 8V	HS 8H	HS 12	HS 18
WHITE	M.R.P.	61.00	79.00	91.00	130.00	156.00	164.00	203.00	278.00
-	PKG.	20	10	10	05	05	05	05	05
-	MASTER CARTON IN NOS	480	280	240	140	120	120	80	60

SUITABLE FOR WOODEN BOXES

PRODUCT CODE	ITEM NAME	WOODOX PLATES		PKG	MASTER CARTON IN NOS
		M.R.P. / RATE PER UNIT			
		WHITE			
75101	1 / 2 Module (5" x 5")	79.00		10	480
75104	4 Module (5" x 7")	117.00		10	360
75106	6 Module (5" x 9")	148.00		10	320

Hi-ClassTM
WoodoxTM Plate



1/2 Module
5" X 5"



4 Module
5" X 7"



6 Module
5" X 9"

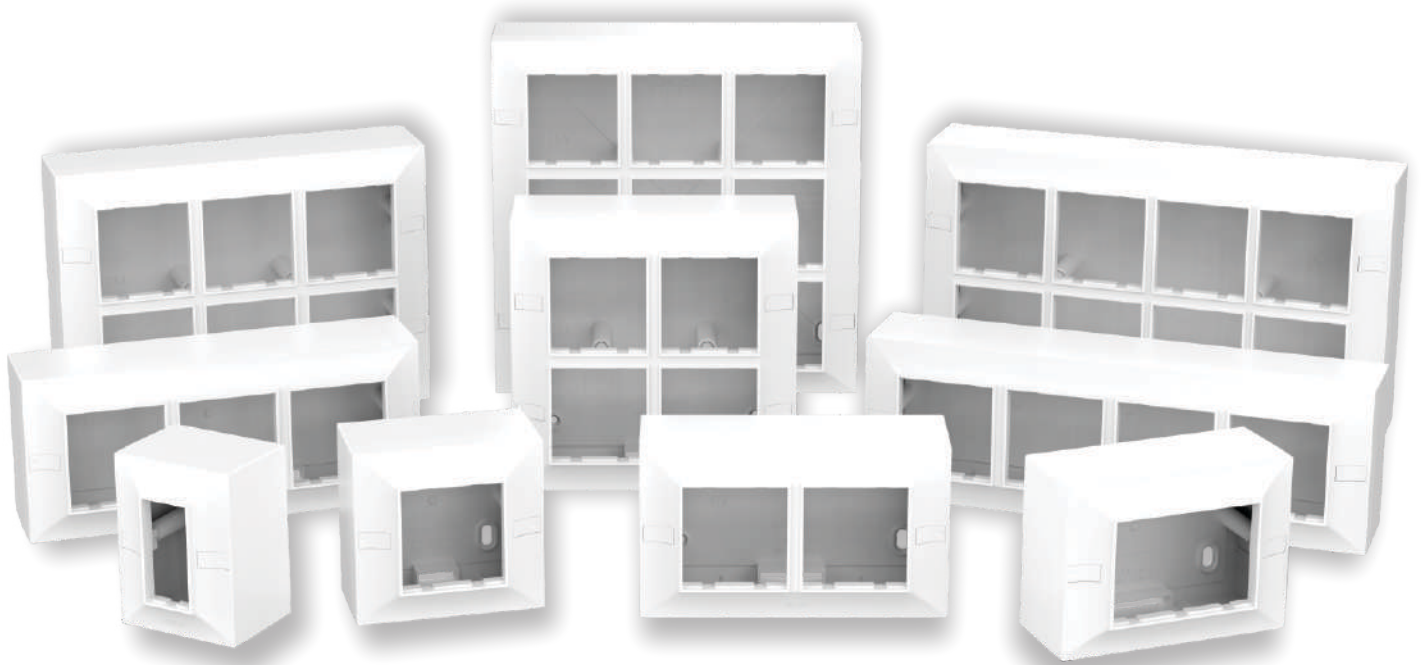

Range available from 1 Module to 18 Modules (Dimension in mm)

1 Module



60 x 86 mm
(2.5' x 3.5')

2 Module



90 x 86 mm
(3.5' x 3.5')

3 Module



115 x 86 mm
(4.5' x 3.5')

4 Module



145 x 86 mm
(6' x 3.5')

6 Module



197 x 86 mm
(8' x 3.5')

9 Module



270 x 86 mm
(10.5' x 3.5')

8 Module (H)



250 x 86 mm
(10' x 3.5')

8 Module (V)



145 x 145 mm
(6' x 6')

12 Module



197 x 145 mm
(8' x 6')

16 Module



250 x 145 mm
(10' x 6')

18 Module



220 x 220 mm
(8.5' x 8.5')

BOXON™
WHITE Modular Plate with Surface Boxes

MODULES		1M	2M	3M	4M	6M	8M (V)	8M (H)	9M	12M	16M	18M
COLOUR	PROD. CODE	85001	85002	85003	85004	85006	85007	85008	85009	85012	85016	85018
WHITE	M.R.P.	68.00	92.00	105.00	121.00	162.00	185.00	197.00	212.00	239.00	346.00	375.00
-	PKG	20	20	10	10	10	10	10	10	05	05	05
-	MASTER CARTON IN NOS	320	240	240	240	180	160	160	160	120	80	90

BOXONTM PLUS

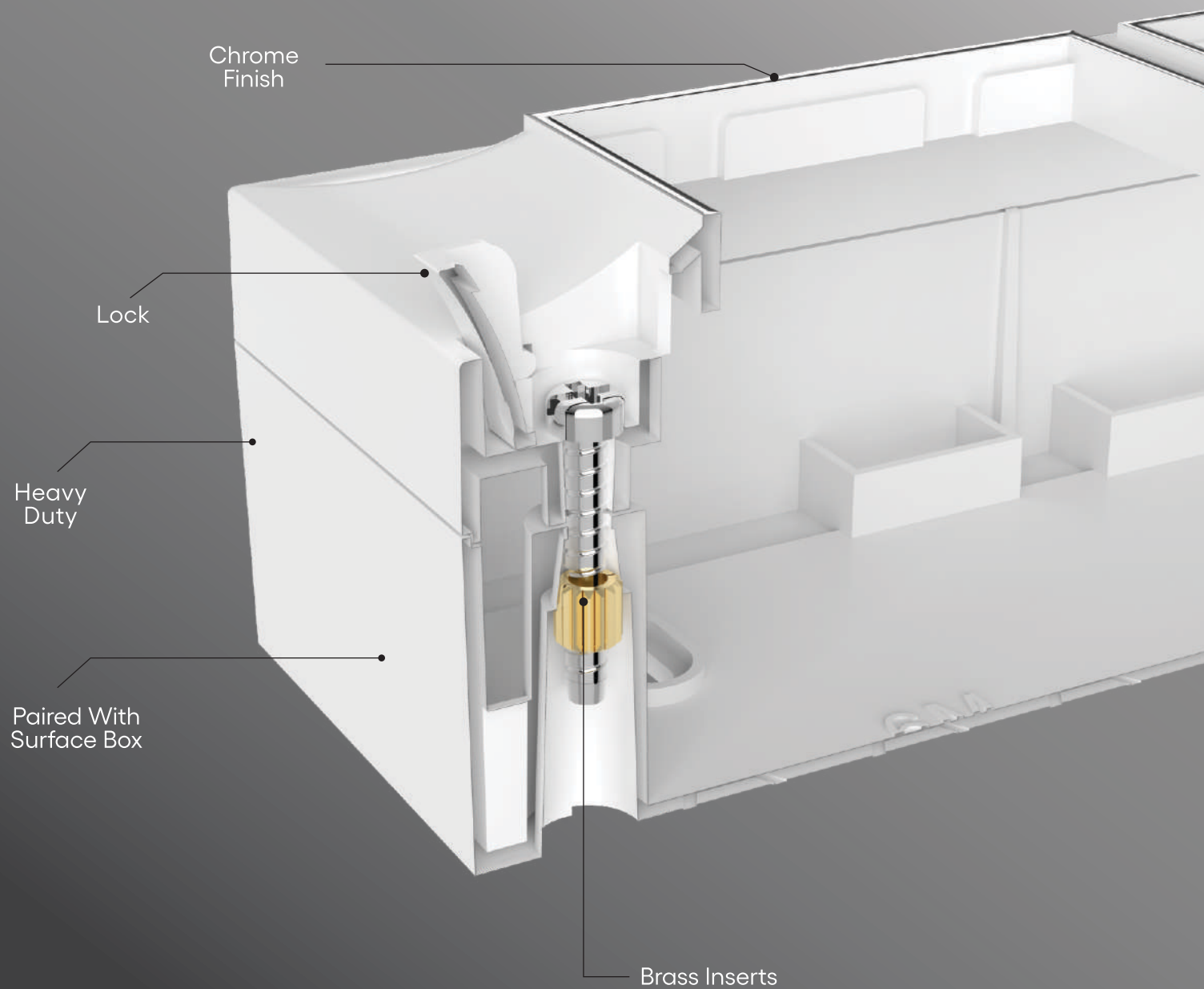



Range available from 1 Module to 18 Modules (Dimension in mm)

1 Module



60 x 86 mm
(2.5' x 3.5')

2 Module

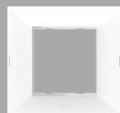

90 x 86 mm
(3.5' x 3.5')

3 Module



115 x 86 mm
(4.5' x 3.5')

4 Module



145 x 86 mm
(6' x 3.5')

6 Module



197 x 86 mm
(8' x 3.5')

9 Module



270 x 86 mm
(10.5' x 3.5')

8 Module (H)



250 x 86 mm
(10' x 3.5')

8 Module (V)



145 x 145 mm
(6' x 6')

12 Module



197 x 145 mm
(8' x 6')

16 Module



250 x 145 mm
(10' x 6')

18 Module

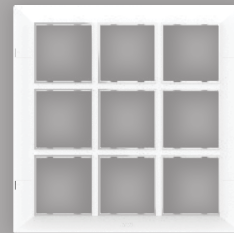

220 x 220 mm
(8.5' x 8.5')

BOXONTM PLUS Modular Plate with Surface Boxes

MODULES		1M	2M	3M	4M	6M	8M (V)	8M (H)	9M	12M	16M	18M
COLOUR	PROD. CODE	85101	85102	85103	85104	85106	85107	85108	85109	85112	85116	85118
WHITE	M.R.P.	72.00	98.00	111.00	129.00	172.00	206.00	218.00	236.00	266.00	395.00	429.00
-	PKG	20	20	10	10	10	10	10	10	05	05	05
-	MASTER CARTON IN NOS	320	240	240	240	180	160	160	160	120	80	90



Range available from 1 Module to 18 Modules (Dimension in mm)

1/2 Module



75 x 72 mm
(3' x 3')

3 Module



100 x 72 mm
(4' x 3')

4 Module



135 x 72 mm
(5.5' x 3')

6 Module



210 x 72 mm
(8' x 3')

8 Module (H)



230 x 72 mm
(9' x 3')

8 Module (V)



135 x 130 mm
(5.5' x 5')

12 Module



210 x 130 mm
(8' x 5')

16 Module



230 x 145 mm
(9' x 6')

18 Module

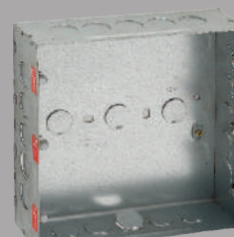

210 x 200 mm
(8' x 8')

Hi-Fi G.I. Metal Boxes

MODULES	1-2 M	3 M	4 M	6 M	8 M (V)	8 M (H)	12 M	16 M	18 M
PROD. CODE	86001-2	86003	86004	86006	86007	86008	86012	86016	86018
M.R.P.	88.00	106.00	127.00	193.00	239.00	239.00	313.00	352.00	419.00
PKG	10	10	10	10	05	05	05	05	05
MASTER CARTON IN NOS	200	160	120	120	60	100	60	50	40



ECKO SWITCH

Switch your way

PROD. CODE	DESCRIPTION	RATE ₹	STD./MST. PKG.
PLUS 6AMP. SWITCH / INDICATOR			
4001	1 Way Switch	46.00	20/1200
4002	2 Way Switch	49.00	20/1100
4003	Bell Push	50.00	20/1100
4004	Indicator	50.00	20/1100
Ecko 6AMP. SWITCH			
4071	1 Way Switch	47.00	20/1200
4072	2 Way Switch	50.00	20/1100
4073	Bell Push	51.00	20/1100
PLUS 6AMP. SOCKETS			
4036	3 Pin Socket	51.00	10/800
PLUS 6A BED SWITCH / DINGO 6A BED SWITCH			
4042	Plus Bed Switch	50.00	20/1100
4043	Plus Bed Bell Push	54.00	20/1100
71701	Dingo Bed Switch	52.00	20/800
71702	Dingo Bed Bell Push	56.00	20/800
PLUS T. V. SOCKET / KIT- KAT FUSE			
4007	Mini TV Antenna	56.00	20/1100
4008	Socket Type T. V. Antenna	70.00	10/500
4016	10A Kit-Kat Fuse	76.00	10/500
4017	16A Kit-Kat Fuse	88.00	10/550
PLUS DIMMER / FAN REGULATOR			
4009	Switch Type Mini Dimmer 450 W	275.00	10/550
4010	Socket Type Medium Dimmer 450 W	288.00	10/550
4011	Mini Switch Type 4 Step Regulator 100 W	367.00	10/550
P-4012	Medium Socket Type 5 Step Regulator 100 W	388.00	10/550
PLUS TELEPHONE JACK / COMPUTER JACK			
4013	Mini RJ 11 2 Line Tel. Jack	104.00	20/1100
4014	Medium Rj 11 2 Line Tel. Jack	124.00	10/500
4015	RJ 45 Computer Jack	221.00	10/500



4001



4002



4003



4004



4071



4072



4073



4036



4042



4043



71701



71702



4007



4008



4016



4017



4009



4010



4011

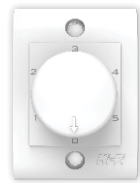

4012



4013

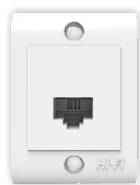

4014



4015

PROD. CODE	DESCRIPTION	RATE ₹	STD./MST. PKG.
PLUS 20A. SWITCH / SOCKET			
4018	20A. 1 Way Switch	123.00	10/300
4019	20A. 2 Way Switch	177.00	10/300
4020	16 & 6A. Universal Socket	127.00	10/300
Ecko 20A. SWITCH			
4075	20A. 1 Way Switch	124.00	10/300
4076	20A. 2 Way Switch	178.00	10/300
4034	Mini 32A D. P. Switch with Ind.	313.00	10/300
PLUS 32AMP. PC D. P. SWITCH			
101130	Surface Type PC D. P. Switch	240.00	05/100
4026	Surface Type D. P.	255.00	05/100
4025	Concealed Type D. P.	255.00	05/100
6/20 AMP. DOUBLE S. S. COMBINED WITH INDICATOR & BOX			
101132	Hi-Fi 6A Double S. S. Combined (with Junction Box) (PC)	293.00	10/160
101133	Hi-Fi 20A Double S. S. Combined (2 + 2) Switch + Socket With Indicator (with Junction Box) (PC)	522.00	05/90
PLUS 6 AMP. S. S. COMBINED			
4037	6A. S. S. Combined	112.00	10/300
4038	6A. S. S. Combined with Box	158.00	10/300
PLUS 20A. S. S. COMBINED / 16 & 6A. 5 IN 1			
4021	20A. S. S. Combined	210.00	05/100
4022	20A. S. S. Combined with Box	270.00	05/100
4023	Universal 5 in 1 with Fuse & Indicator	320.00	05/100
4027	5 in 1 with Box	373.00	05/60
PLUS 20A. S. S. COMBINED / 16 & 6A. 5 IN 1 (Unbreakable)			
4061	20A. S. S. Combined with Ind. (Unbreakable)	210.00	05/160
*4065	20A. S. S. Box Type with Ind. (Unbreakable)	270.00	05/100
4063	5 in 1 with Fuse & Ind. (Unbreakable)	320.00	05/110
*4064	5 in 1 with Box (Unbreakable)	373.00	05/100



4018



4019



4020



4075



4076



4034



101130



4026



4025



101132



101133



4037



4038



4021



4023



4065



4064

* Also Available in Brown Colour.

elle[®] Range
Unbreakable



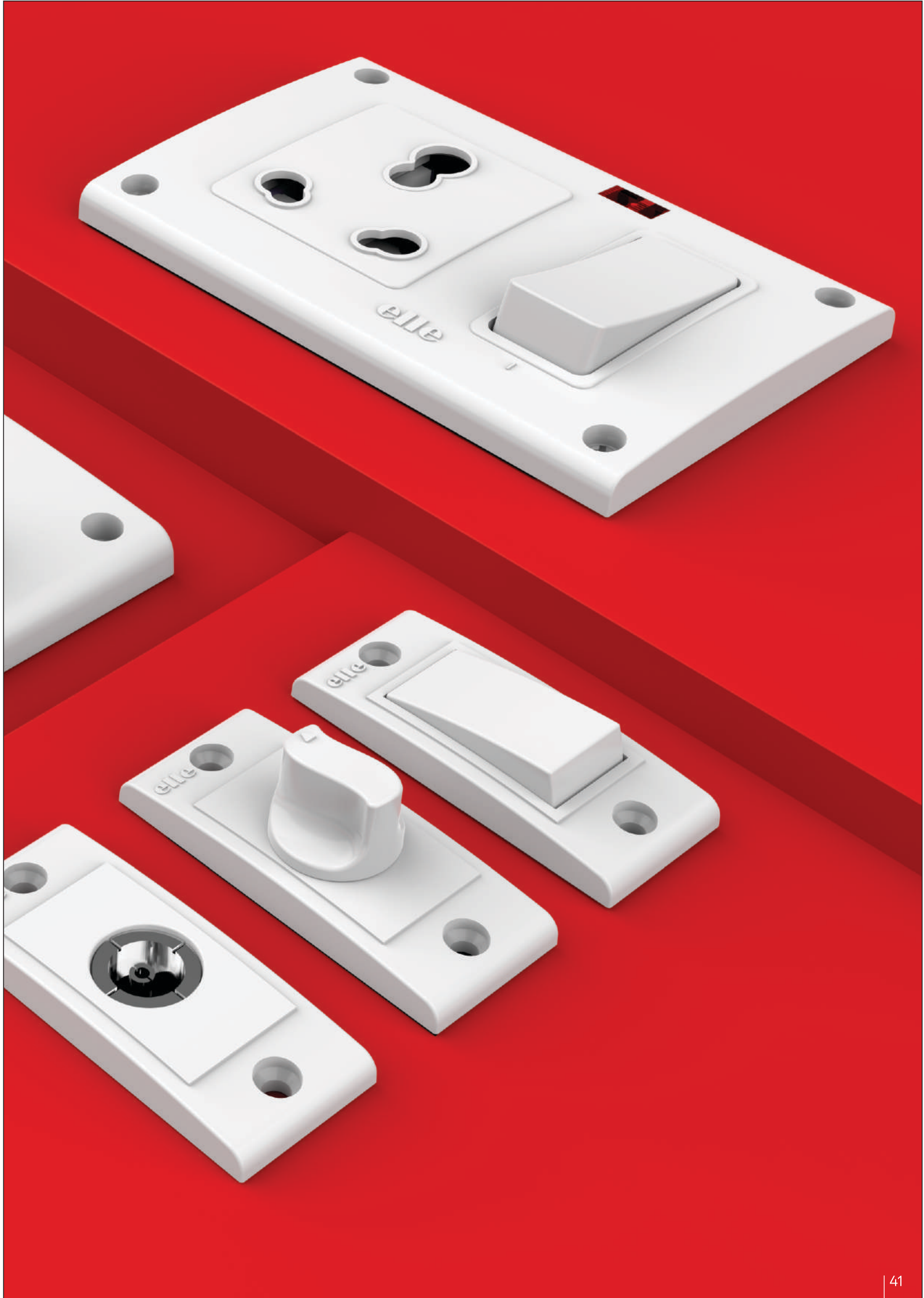

ELLE 6 AMP. SWITCH / INDICATOR WHITE / BROWN

PROD. CODE	DESCRIPTION	RATE ₹	STD./MST. PKG.
EL5001	6A 1 Way Switch	28.00	20/1200
EL5002	6A 2 Way Switch	50.00	20/600
EL5003	6A Bell Push Switch	50.00	20/600
EL5004	Indicator	62.00	20/600

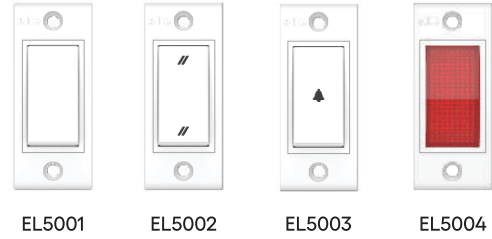

ELLE 6 AMP. 3 PIN SOCKET

EL5005	6A 3 Pin Socket	55.00	20/800
--------	-----------------	-------	--------



EL5005

ELLE TV SOCKET / TELEPHONE JACK / KIT KAT FUSE

EL5006	Mini TV Socket	70.00	20/400
EL5007	Mini Telephone Jack	100.00	20/400
EL5008	10A Kit Kat Fuse	84.00	10/200

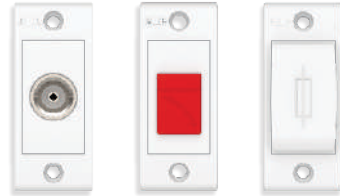

EL5006 EL5007 EL5008

ELLE ELECTRONIC DIMMER / FAN REGULATOR

EL5009	Mini Dimmer	380.00	10/400
EL5010	Mega Dimmer	395.00	10/300
EL5011	Mini Regulator	380.00	10/400
EL5012	Mega Regulator	395.00	10/300



EL5009 EL5010 EL5011 EL5012

ELLE 20 AMP. SWITCH

EL5021	20A 1 Way Switch	121.00	10/300
EL5022	20A 2 Way Switch	192.00	10/300

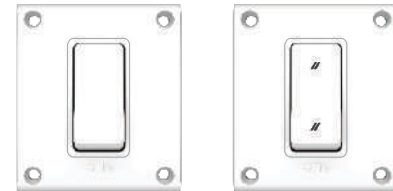

EL5021 EL5022

ELLE 16A & 6 AMP. UNI. SOCKET

EL5023	16A. & 6A.Universal Socket	136.00	10/300
--------	----------------------------	--------	--------



EL5023

PROD. CODE	DESCRIPTION	RATE ₹	STD./MST. PKG.
ELLE 20AMP. S.S.COMBINED		WHITE / BROWN	

EL5026	20A S.S. Combined	215.00	10/160
EL5027	20A S.S. Combined With Junction Box	260.00	10/100



EL5026

ELLE 20A. & 16AMP. 5 IN 1 S.S.COMBINED			
---	--	--	--

EL5028	5 in 1 S.S. Combined	290.00	05/110
EL5029	5 in 1 S.S. Combined With Junction Box	315.00	05/100



EL5028

HI-FI SINGLE POLE TINY MCB			
-----------------------------------	--	--	--

HF1006	6A SP MCB	250.00	10/300
HF1010	10A SP MCB	250.00	10/300
HF1016	16A SP MCB	250.00	10/300
HF1020	20A SP MCB	250.00	10/300
HF1025	25A SP MCB	250.00	10/300
HF1032	32A SP MCB	250.00	10/300

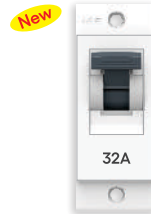

HI-FI DOUBLE POLE TINY MCB			
-----------------------------------	--	--	--

HF2006	6A DP MCB	560.00	05/150
HF2010	10A DP MCB	560.00	05/150
HF2016	16A DP MCB	560.00	05/150
HF2020	20A DP MCB	560.00	05/150
HF2025	25A DP MCB	560.00	05/150
HF2032	32A DP MCB	560.00	05/150



DOUBLE COLOUR RANGE

PROD. CODE	DESCRIPTION	RATE ₹	STD./MST. PKG.
HI-FI - 6A. SWITCHES / INDICATOR			
H 01	1 Way Switch	44.00	20/1400
H 02	2 Way Switch	48.00	20/1000
H 03	Bell Push	48.00	20/1000
H 04	Indicator	48.00	20/1000
HI-FI - 6A. SOCKETS			
H 70	3 Pin Socket	66.00	10/800
HI-FI - T. V. ANTENNA SOCKET / RJ 11 / RJ 45 JACK			
H 12	Mini T. V. Antenna Socket	67.00	20/1100
H 19	Mini RJ 11 2 Line Telephone	108.00	20/1100
H 21	RJ 45 Computer Jack with Shutter	174.00	10/500
HI-FI - ELECTRONIC DIMMER / FAN REGULATOR			
H 14	Mini Dimmer	237.00	10/500
H 15	Medium Dimmer	262.00	10/500
H 16	Mini EME Fan 4 Step Regulator	416.00	10/550
H 17	Medium EME Fan 5 Step Regulator	423.00	10/550
HI-FI - MOTOR STARTER / KIT - KAT FUSE / BUZZER			
H 89	Hi-Fi Single Phase Motor Starter (7.5A, 10A, 16A, 20A, 25A)	272.00	05/250
H 22	Kit - Kat Fuse	82.00	10/500
H 23	Electronic Buzzer	247.00	10/250
HI-FI - 3 IN 1 S. S. COMBINED / 5 IN 1			
H 30	3 in 1 Universal S. S. Combined	337.00	05/200
H 31	5 in 1 Conceal with Fuse & Indicator	401.00	05/100
HI-FI - 20A. SWITCH / SOCKET / 32A. D. P.			
H 25	20A. 1 Way Switch with Indicator	167.00	10/400
H 26	20A. 2 Way Switch	200.00	10/400
H 29	16 & 6A. Uni. Soc. with Safety Shutter	169.00	10/400
H 27	6A. Sumo Bell Push with Indicator	130.00	10/400
H 28	32A. D. P. Switch with Indicator	325.00	10/400



H 01



H 02



H 03



H 04



H 70



H 12



H 19



H 21



H 14



H 15



H 16



H 17



H 89



H 22



H 23



H 30



H 31



H 25



H 29



H 27



H 28

PROD. CODE	DESCRIPTION		RATE ₹	STD./MST. PKG.
HI-FI COVER PLATES				
F 1	Switch Cover	White / Ivory	9.00	100/12000
		Pearl / Cubic	12.00	100/12000
		Sartin	14.00	100/12000
F 2	Socket Cover	White / Ivory	10.00	50/6000
		Pearl / Cubic	15.00	50/6000
		Sartin	17.00	50/6000
F 3	Sumo Socket Cover	White / Ivory	30.00	10/450
		Pearl / Cubic	49.00	10/450
		Sartin	51.00	10/450
HI-FI COVER PLATES				
F 4	S. S. Combined Cover	White / Ivory	49.00	05/270
		Pearl / Cubic	69.00	05/270
		Sartin	69.00	05/270
F 5	5 in 1 Cover	White / Ivory	64.00	05/225
		Pearl / Cubic	100.00	05/225
		Sartin	100.00	05/225



F 1 F 2 F 3

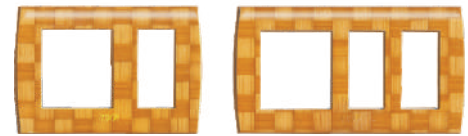

F 4 F 5

Sartin
Cover Plates



SLIM PLATES
SUITABLE FOR WOODEN BOXES

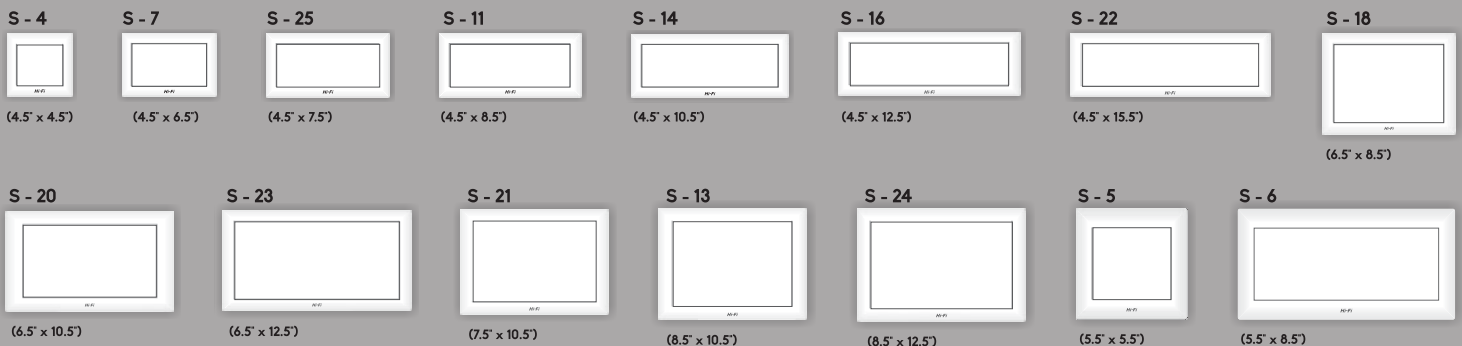

HI-FI SLIM COLOUR PLATES (Dimension in mm)

S.No.	Product Code	Item Name	Rate Per Unit	Size in mm H x W	Pkg. Std.
			White		
1	S - 4	4 ½" x 4 ½" Slim Plate	66.00	107 x 110	10
2	S - 7	4 ½" x 6 ½" Slim Plate	86.00	107 x 157	10
3	S - 25	4 ½" x 7 ½" Slim Plate	127.00	114 x 191	10
4	S - 11	4 ½" x 8 ½" Slim Plate	118.00	107 x 210	10
5	S - 14	4 ½" x 10 ½" Slim Plate	163.00	114 x 267	10
6	S - 16	4 ½" x 12 ½" Slim Plate	189.00	114 x 320	10
7	S - 22	4 ½" x 15 ½" Slim Plate	239.00	115 x 395	10
8	S - 5	5 ½" x 5 ½" Slim Plate	83.00	127 x 127	10
9	S - 6	5 ½" x 8 ½" Slim Plate	159.00	127 x 210	10
10	S - 18	6 ½" x 8 ½" Slim Plate	190.00	165 x 217	10
11	S - 20	6 ½" x 10 ½" Slim Plate	252.00	165 x 267	10
12	S - 23	6 ½" x 12 ½" Slim Plate	280.00	165 x 320	10
13	S - 21	7 ½" x 10 ½" Slim Plate	274.00	190 x 267	10
14	S - 13	8 ½" x 10 ½" Slim Plate	312.00	217 x 267	10
15	S - 24	8 ½" x 12 ½" Slim Plate	348.00	217 x 320	10

PROD. CODE	DESCRIPTION	RATE ₹	STD./MST. PKG.
PLUS ANGLE / BATTEN HOLDER			
4029	Plus Angle Holder Skirt (Urea)	48.00	20/480
4030	Plus Batten Holder Skirt (Urea)	48.00	20/480
4039	Plus Angle Holder Square (Unbreakable)	53.00	20/600
4040	Plus Batten Holder Square(Unbreakable)	53.00	20/600



4029



4030

PLUS CEILING ROSES			
4031	Plus Ceiling Rose (2 Plate)	45.00	20/600
4032	Plus Ceiling Rose (3 Plate)	55.00	20/600
4035	Plus Jumbo Ceiling Rose (2 Plate)	49.00	20/600
4044	Plus Jumbo Ceiling Rose (3 Plate)	58.00	20/600
4051	Plus Ceiling Rose PC (2 Plate) (Unbreakable)	51.00	20/600
4052	Plus Ceiling Rose PC (3 Plate) (Unbreakable)	59.00	20/600



4031



4032

DINGO PLATE TYPE 5" X 5" ANGLE /BATTEN HOLDER / C.R			
71501	Dingo Plate Type Angle Holder Skirt with Metal Ring 2A. 240~	122.00	10/300
71502	Dingo Plate Type Batten Holder Skirt with Metal Ring 2A. 240~	122.00	10/300
71501B	Dingo Plate Type Angle Holder Skirt with Metal Ring (Jet Black) 2A. 240~	150.00	10/300
71502B	Dingo Plate Type Batten Holder Skirt with Metal Ring (Jet Black) 2A. 240~	150.00	10/300
71503	Dingo Plate Type Ceiling Rose (2 Plate)	106.00	10/360
71503B	Dingo Plate Type Ceiling Rose (2 Plate) (Jet Black)	130.00	10/360
71504	Dingo Plate Type Ceiling Rose (3 Plate)	118.00	10/360
71505	Dingo Round Plate B / H with Metal Ring	130.00	10/140



71501



71502



71501B



71502B



71505



71503

HI-FI CEILING ROSE			
H 38	Hi-Fi Ceiling Rose (2 Plate)	43.00	20/600
H 53	Hi-Fi Ceiling Rose (3 Plate)	48.00	20/600
H 54	Hi-Fi Jumbo Ceiling Rose (2 Plate)	48.00	20/600
H 95	Hi-Fi Jumbo Ceiling Rose (3 Plate)	56.00	20/600



H 38



H 54

HI-FI "PREMIUM" ANGLE / BATTEN HOLDER			
H 43	Premium Angle Holder Skirt Metal Ring	57.00	20/600
H 44	Premium Batten Holder Skirt Metal Ring	57.00	20/600



H 43



H 44

HI-FI JUMBO BATTEN HOLDER (Unbreakable)			
H 47	Jumbo Batten Holder	60.00	20/600



H 47

HI-FI - 3 PIN TOP			
H 32	6AMP. 3 Pin Top (PC)	74.00	20/720
H 33	16AMP. 3 Pin Top (PC)	120.00	20/480
H 34	6AMP. 3 Pin Top (Urea)	82.00	20/500
H 35	16AMP. 3 Pin Top (Urea)	128.00	10/250
H 94	16Amp. 3 Pin Top (PC) Heavy Duty	200.00	20/480
901 218	6AMP. 3 Pin Top	106.00	20/720
901 217	16AMP. 3 Pin Top	148.00	20/480



H 32



H 33



H 94



901 218



901 217

PROD. CODE	DESCRIPTION	RATE ₹	STD./MST. PKG.
ELLEYS PLATE TYPE 4 x 4 ANGLE / BATTEN HOLDER			
71506	4"X4" Plate Type Angle Holder with Metal Ring	100.00	10/300
71507	4"X4" Plate Type Batten Holder with Metal Ring	100.00	10/300
HI-FI PLATE TYPE 4 1/2" x 4 1/2" ANGLE / BATTEN /C.R./ ROUND PLATE			
H 49	Plate Type Angle Holder	87.00	10/400
H 50	Plate Type Batten Holder	87.00	10/400
H 72	Plate Type A / H with Metal Ring	94.00	10/400
H 73	Plate Type B/ H with Metal Ring	94.00	10/400
H 48	Plate Type Ceiling Rose (2 Plate)	94.00	10/400
H 57	Plate Type Ceiling Rose (3 Plate)	105.00	10/400
H 51	Round Plate Big	93.00	10/480
HI-FI PLATE TYPE "MEGA" 5" X 5" ANGLE /BATTEN HOLDER/C.R.			
H 85	Plate Type Mega 5" x 5" Angle Holder with Metal Ring	105.00	10/300
H 86	Plate Type Mega 5" x 5" Batten Holder with Metal Ring	105.00	10/300
H 87	Plate Type MEGA 5" x 5" Ceiling Rose (2 Plate)	91.00	10/300
H 88	Plate Type MEGA 5" x 5" Ceiling Rose (3 Plate)	97.00	10/300
HI-FI "GOLD" A / B HOLDER / LAMP HOLDER / CEILING ROSE			
* HG 4	Gold Angle Holder Metal Ring	68.00	20/600
* HG 5	Gold Batten Holder Metal Ring	68.00	20/600
HG 6	Gold Ceiling Rose (2 Plate)	48.00	20/600
HG 7	Gold Ceiling Rose (3 Plate)	56.00	20/600
HG 9	Gold Jumbo Ceiling Rose (2 Plate)	53.00	20/600
HG 10	Gold Jumbo Ceiling Rose (3 Plate)	64.00	20/600
HG 8	Gold Lamp Holder Skirt (With Metal Ring) (PC)	50.00	20/840
H 55	Jumbo Adaptor	31.00	30/1500
DINGO ANGLE HOLDER / BATTEN HOLDER (4.5" x 4.5")			
71601	Dingo Round Type Angle Holder 4.5"x 4.5"	85.00	20/400
71602	Dingo Round Type Batten Holder 4.5" x 4.5"	85.00	20/400
71603	Dingo Jumbo Batten Holder	90.00	20/400

* Also Available in Brown & Turkish Blue Colour.



71506



71507



H 49



H 73



H 48



H 51



H85



H86



H 87



HG 4



HG 5



HG 6



HG 9



HG 8



H 55



71601



71602



71603



RHINO
FLEXBOX

**A FLEXIBLE
EXTENTION BOX
FOR EASY
CONNECTIONS**

Connect up to three devices at once with our modernized extension box, designed for effortless multitasking.

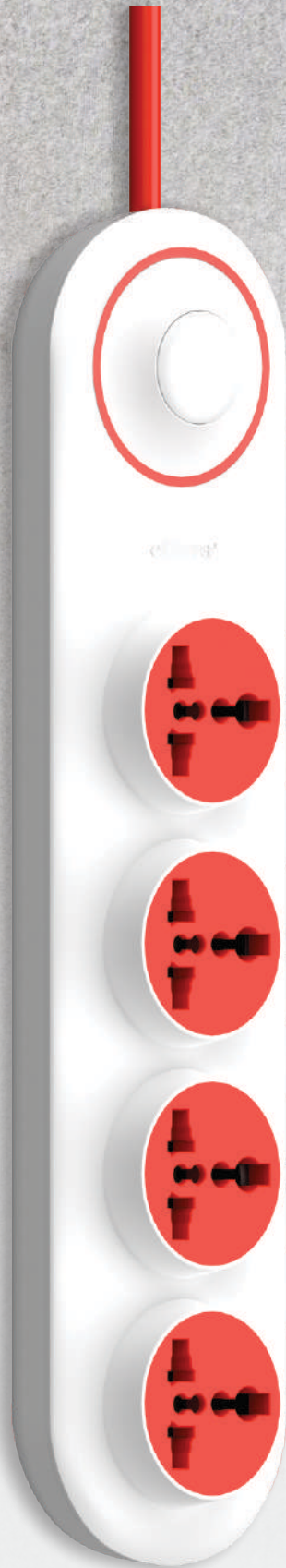

QURO
SPIKE GUARD

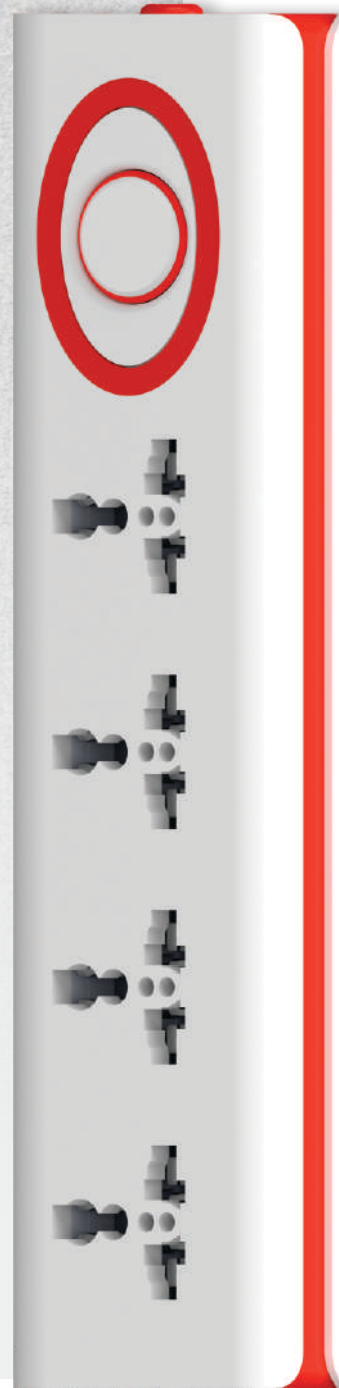

Zap
SPIKE GUARD

PROD. CODE	DESCRIPTION	RATE ₹	STD./MST. PKG.
DINGO SUPER COMBO AC BOX / MINI DP MCB WITH ENCLOSURE			
72201	Dingo AC Box with Dingo 4M Plate, 16A Plug, 25A SP MCB, 16A Multi Socket & Indicator	1105.00	01/50
918 101	Mini DP C 32 A MCB with Enclosure	580.00	10/150
918 102	Mini DP C 20 A MCB with Enclosure	580.00	10/150



72201

918 101

UNIVERSAL MULTI PLUG / TRAVEL ADAPTOR			
H 83	Dingo+ 3 Pin Universal Multi Plug with Supply Indicator 16 & 6 Amp. 240V~	252.00	10/300
H 84	Dingo 3 Pin Universal Travel Multi Plug 6 Amp. 240V~	153.00	10/560
901 213	DICI - 3 Pin Uni. Multi Plug with Supply Indi. 6 Amp. 240V~	217.00	10/400
901 214	ENZO Conversion Plug 6 Amp. 240V~	95.00	20/1200
901 215	ZICO International 3 Pin Adapter 6A/13 Amp. 240V~	126.00	10/600
901 216	Universal Travel Adapter	270.00	10/250



H 83

H 84

901 213

901 214

901 215

901 216

FLEX BOX 6A. 240V. / POWER STRIP			
508 176	OLLO Flex Box (2 Pin Flex Box with 4.2 Mtrs. Cable with Master Switch, International Sockets & LED Indicator)	750.00	05/75
508 177	OLLO Flex Box (3 Pin Flex Box with 4 Mtrs. Cable with Master Switch, International Sockets & LED Indicator)	850.00	05/75
508 191	RHINO Flex Box (2 Pin Flex Box with 4 Mtrs. Cable with Master Switch, International Sockets & LED Indicator)	515.00	05/75
508 181	ZYNEX Power Strip (4 Way Power Strip with 2 Mtrs. Cable, Master Switch, International Sockets, Overload Protector Switch & LED Indi.)	1020.00	05/80
508 182	ZAP Spike Guard (4 Way Spike Guard with 1.5 Mtrs. Cable, Master Switch, International Sockets & LED Indicator)	730.00	05/80
508 183	QURO Spike Guard (4 Way Spike Guard with 1.5 Mtrs. Cable, Master Switch, International Sockets & LED Indicator)	705.00	05/80
508 184	SOLIX Spike Guard (16A 3 Way Spike Guard with 4 Mtrs. Cable, Individual Switch, LED Indicator, Safety Shutter & Surge Protector)	2300.00	05/30

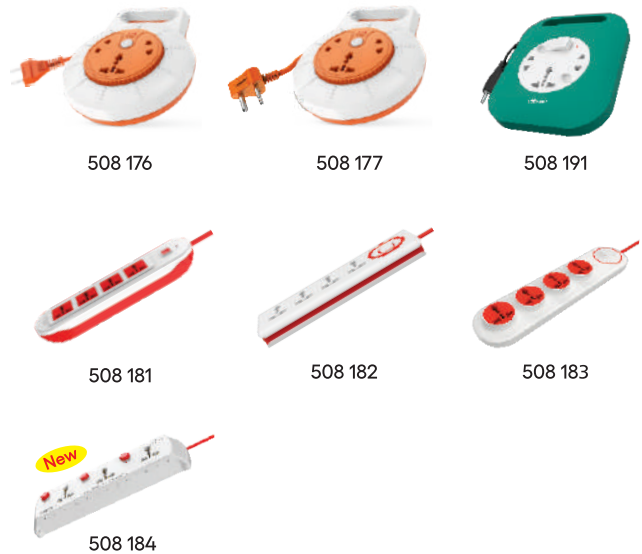

508 176

508 177

508 191

508 181

508 182

508 183

508 184

WIRELESS DOOR BELL			
901 221	BellX Wireless Plug-In Door Bell (with remote control)	2320.00	10/40
901 222	Mellow Wireless Door Bell (with remote control)	1120.00	05/60



901 221

901 222

DING DONG BELL / MUSICAL BELL			
901 232	Dingit Musical Bell	590.00	10/120
901 223	Horizon Blue	320.00	10/150
901 224	Mystic Breeze	320.00	10/150
901 230	Pearl Breeze	565.00	10/120
901 231	Round Parrot Bell	395.00	10/120



901 232

901 223

901 224

901 230

901 231

PROD. CODE	DESCRIPTION	RATE ₹	STD./MST. PKG.
HI-FI - SIX OUTLET SWITCH ADAPTOR			
H 77	Hi-Fi Six Outlet Switch Adaptor 3 - International Socket, 3 - 2 Pin Conversion Outlet with Switch Indicator & Fuse	1200.00	01/45
HI-FI SPIKE PROTECTOR / POWER STRIP			
1001	Hi-Fi Universal Power Strip (2Mtrs.)	850.00	01/48
1002	Hi-Fi Spike Protector (2Mtrs.) (240 V. / 50Hz / 13 A. A/C Max. Output 6A. - 230 V.)	1150.00	01/48
HI-FI AERO FLEX BOX 6A. 240V. / 16 AMP. FLEX BOX			
1031	2 Pin 5 Mtrs. Flex Box	545.00	05/60
1032	3 Pin 5 Mtrs. Flex Box	800.00	05/50
1033	2 Pin 10 Mtrs. Flex Box	800.00	05/50
HI-FI - EXTENSION CORD			
H 78	Hi-flex Extension Cord 2 Pin 5 Mtrs. 2 Pin 8 Mtrs. 3 Pin 4 Mtrs.	580.00 720.00 730.00	05/60 05/60 05/60
H 79	Vector Extension Cord 2 Pin 5 Mtrs. 2 Pin 8 Mtrs. 3 Pin 4 Mtrs.	530.00 680.00 680.00	05/60 05/60 05/60
HI-FI DING DONG BELL			
H 93	Hi-Fi Ding Dong Bell	275.00	10/120
H 41	"Gama" Ding Dong Bell	308.00	10/120
H 60	"Stereo" Ding Dong Bell	460.00	05/60
952	Ikon Bell IKON VARIETY (Hindi Tune / Multi Tune / Please Open Door / Gayatri Mantra)	515.00	05/60
HI-FI - PARROT BELL / MUSICAL ELECTRONIC BELL			
H 45	Hi-Fi Electronic Parrot Bell	510.00	05/60
H 61	Mini Parrot Bell	375.00	05/200
H 39	"Hi-Fi" Electronic Multi Tune Musical / Mantra Bell	560.00	05/100



H 77



1001



1002



1031



1032



H 78



H 79



H 93



H 41



H 60



952



H 45



H 61



H 39

Heavy Duty Switchgear
Products & many more
Total protection of the electrical energy.

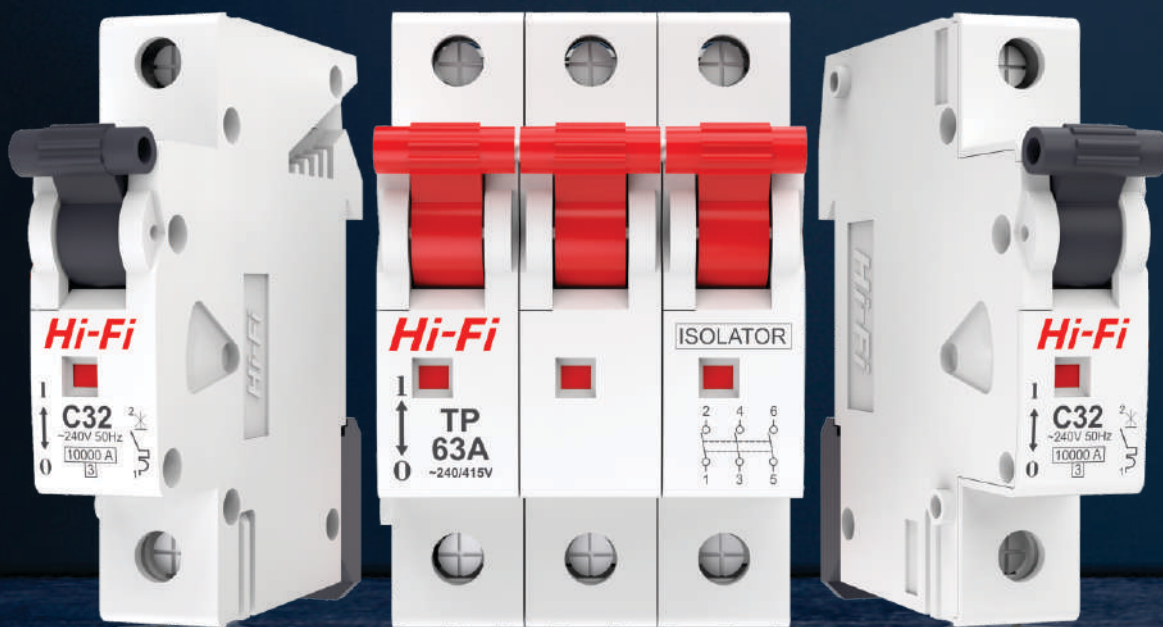

- MCBs
- ISOLATORS
- RCCBs
- CHANGE OVER SWITCHES
- DISTRIBUTION BOARDS

Fits in all Distribution Boards

Hi-Fi B/C SERIES MCB

Fits in all Distribution Boards.

PROD. CODE	RATING	M.R.P. ₹	STD./MST. PKG.
SINGLE POLE MCB B/C SERIES 10KA			
910 101	6 A	198.00	12/120
910 102	10 A	198.00	12/120
910 103	16 A	198.00	12/120
910 104	20 A	198.00	12/120
910 105	25 A	198.00	12/120
910 106	32 A	198.00	12/120
910 107	40 A	430.00	12/120
910 108	63 A	541.00	12/120



SINGLE POLE NEUTRAL MCB B/C SERIES 10KA			
910 109	6 A	522.00	06/60
910 110	10 A	522.00	06/60
910 111	16 A	522.00	06/60
910 112	20 A	522.00	06/60
910 113	25 A	522.00	06/60
910 114	32 A	522.00	06/60
910 115	40 A	735.00	06/60
910 116	63 A	945.00	06/60



DOUBLE POLE MCB B/C SERIES 10KA			
910 117	6 A	555.00	06/60
910 118	10 A	555.00	06/60
910 119	16 A	555.00	06/60
910 120	20 A	555.00	06/60
910 121	25 A	555.00	06/60
910 122	32 A	555.00	06/60
910 123	40 A	855.00	06/60
910 124	63 A	1030.00	06/60



THREE POLE MCB B/C SERIES 10KA			
910 125	6 A	1005.00	04/40
910 126	10 A	1005.00	04/40
910 127	16 A	1005.00	04/40
910 128	20 A	1005.00	04/40
910 129	25 A	1005.00	04/40
910 130	32 A	1005.00	04/40
910 131	40 A	1307.00	04/40
910 132	63 A	1560.00	04/40



HI-FI MCB / ISOLATOR CHANGE OVER SWITCH

PROD. CODE	RATING	M.R.P. ₹	STD./MST. PKG.
THREE POLE NEUTRAL MCB B/C SERIES 10KA			
910 133	6 A	1255.00	03/30
910 134	10 A	1255.00	03/30
910 135	16 A	1255.00	03/30
910 136	20 A	1255.00	03/30
910 137	25 A	1255.00	03/30
910 138	32 A	1255.00	03/30
910 139	40 A	1583.00	03/30
910 140	63 A	1920.00	03/30



FOUR POLE MCB B/C SERIES 10KA			
910 141	6 A	1365.00	03/30
910 142	10 A	1365.00	03/30
910 143	16 A	1365.00	03/30
910 144	20 A	1365.00	03/30
910 145	25 A	1365.00	03/30
910 146	32 A	1365.00	03/30
910 147	40 A	1728.00	03/30
910 148	63 A	2115.00	03/30
910 149	100 A	4135.00	03/30



ISOLATOR			
DOUBLE POLE			
911 101	40 A	475.00	06/60
911 102	63 A	575.00	06/60
THREE POLE			
911 105	40 A	830.00	03/30
911 106	63 A	910.00	03/30
FOUR POLE			
911 103	40 A	1065.00	03/30
911 104	63 A	1088.00	03/30

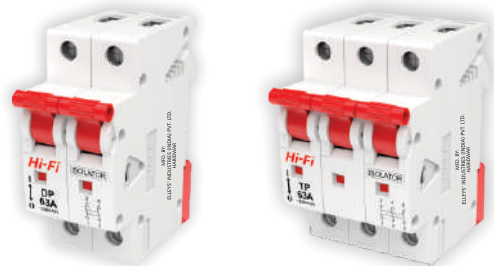

CHANGE OVER SWITCH			
DOUBLE POLE			
925 101	40 A	1445.00	06/60
925 102	63 A	1740.00	06/60
FOUR POLE			
925 103	40 A	2740.00	03/30
925 104	63 A	3375.00	03/30

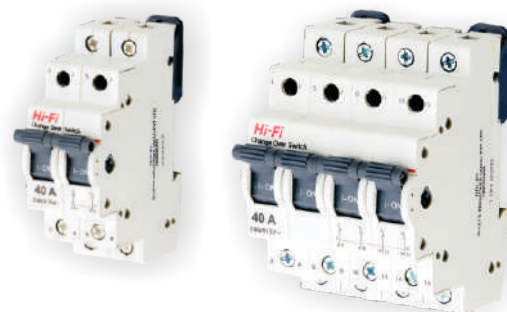

RCCB

PROD. CODE	RATING	SENSITIVITY	DOUBLE POLE ₹	STD./MST. PKG.
DOUBLE POLE				
912 101	25 A	30 mA	2333.00	06/60
912 102	25 A	100 mA	2342.00	06/60
912 104	32 A	30 mA	2333.00	06/60
912 105	32 A	100 mA	2342.00	06/60
912 107	40 A	30 mA	2415.00	06/60
912 108	40 A	100 mA	2564.00	06/60
912 110	63 A	30 mA	3161.00	06/60
912 111	63 A	100 mA	3171.00	06/60



PROD. CODE	RATING	SENSITIVITY	FOUR POLE ₹	STD./MST. PKG.
FOUR POLE				
912 113	25 A	30 mA	3125.00	03/30
912 114	25 A	100 mA	3125.00	03/30
912 116	32 A	30 mA	3125.00	03/30
912 117	32 A	100 mA	3125.00	03/30
912 119	40 A	30 mA	3125.00	03/30
912 120	40 A	100 mA	3125.00	03/30
912 122	63 A	30 mA	3495.00	03/30
912 123	63 A	100 mA	3516.00	03/30



Note : Fits in all Distributions Boards.

ACCL

PROD. CODE	ITEM	M.R.P. ₹	STD./MST. PKG.
AUTOMATIC CHANGEOVER WITH CURRENT LIMITER			
ACCL015	ACCL30A/1.5A - (300W) - 3M	2385.00	1/24
ACCL025	ACCL30A/2.5A - (500W) - 3M	2385.00	1/24
ACCL030	ACCL30A/3.0A - (600W) - 3M	2385.00	1/24
ACCL040	ACCL30A/4.0A - (800W) - 3M	2385.00	1/24
ACCL050	ACCL30A/5.0A - (1000W) - 3M	2385.00	1/24
ACCL060	ACCL30A/6.0A - (1200W) - 3M	2385.00	1/24
ACCL090	ACCL30A/9.0A - (1800W) - 3M	2385.00	1/24
ACCL120	ACCL30A/12.0A - (2400W) - 3M	2385.00	1/24
ACCL150	ACCL30A/15.0A - (3000W) - 3M	2385.00	1/24
ACCL200	ACCL30A/20.0A - (4000W) - 3M	2385.00	1/24



Micro Controller Based Design



Relay Based Single Phase ACCL



Overload Indication via LED



DIN Rail Mounting



Auto Reset Facility

DISTRIBUTION BOARDS

PROD. CODE	NO. OF WAYS	M.R.P ₹	STD./MST. PKG.
SPN DISTRIBUTION BOARD - DOUBLE DOOR (METAL)			
913 101	4 Way (2+2)	1105.00	01/30
913 102	6 Way (2+4)	1250.00	01/24
913 103	8 Way (2+6)	1400.00	01/24
913 106	10 Way (2+8)	1560.00	01/20
913 104	12 Way (2+10)	1715.00	01/16
913 105	16 Way (2+14)	2060.00	01/12



PROD. CODE	NO. OF WAYS	M.R.P ₹	STD./MST. PKG.
TPN DISTRIBUTION BOARD - DOUBLE DOOR (METAL)			
915 101	4 Way (4+12)	3295.00	01/07
915 102	6 Way (6+18)	4040.00	01/05
915 103	8 Way (8+24)	4650.00	01/05
915 104	12 Way (12+36)	6555.00	01/03



PROD. CODE	NO. OF WAYS	M.R.P ₹	STD./MST. PKG.
MCB ENCLOSURE FITTED WITH DIN RAIL (METAL)			
917 101	02/03 Way	284.00	01/114
917 102	04 Way	326.00	01/96



PROD. CODE	NO. OF WAYS	M.R.P ₹	STD./MST. PKG.
MCB ENCLOSURE FITTED WITH DIN RAIL (PLASTIC)			
917 103	01/02 Way	75.00	10/240
917 104	03/04 Way	110.00	05/80



PROD. CODE	ITEM	M.R.P ₹	MST. PKG.
SWITCH FUSE UNIT (REWIRABLE)			
SFU2032	32A / 240V - DP SFU	2350.00	01/10
SFU2063	63A / 240V - DP SFU	6090.00	01/04
SFU3032	32A / 415A - TP SFU	3970.00	01/05
SFU3063	63A / 415A - TP SFU	8650.00	01/03
SFU3100	100A / 415 - TP SFU	15110.00	01/02
SFU3200	200A / 415 - TP SFU	23535.00	01/02



PVC Electrical Insulation Tape

Connecting **Electrical Wires**



Colors Available in **Black, Red, Blue, Yellow, Green & White**

Prod. Code	Description	Rate Per Pkg.	Inner Box Packing Qty. Standard Pkg.	Master Carton Qty.
PVC ELECTRICAL INSULATION TAPE				
95001	<p>PVC Electrical Insulation Tape Dimension (6Mtr x 17mm x 0.125mm) Pkg. 40 Inner Box x 30 = 1200 Units / Master Carton Mix Colour Master Carton Pkg. Detail :- (Black - 480, Red - 240, Blue - 180, Yellow - 180, Green - 120)</p>	₹ 750.00	30 Units	1200 Units
95002	<p>PVC Electrical Insulation Tape Dimension (15Mtr x 17mm x 0.125mm) Pkg. 16 Inner Box x 16 = 256 Units / Master Carton Mix Colour Master Carton Pkg. Detail :- (Black - 128, Red - 32, Blue - 32, Yellow - 32, Green - 32)</p>	₹ 880.00	16 Units	256 Units

- Seamless Finishing
- Effective and Long Lasting Insulation
- High Strength Adhesive
- Great Resistance to High Voltage and Weather



Self Adhesive PVC Tape

Applicable for outdoor & indoor purpose

- ◆ Gujarat
- ◆ Maharashtra
- ◆ Karnataka
- ◆ Telangana
- ◆ Andhra Pradesh
- ◆ Tamil nadu
- ◆ Kerala
- ◆ West Bengal
- ◆ Assam
- ◆ Jharkhand
- ◆ Goa
- ◆ Uttarakhand
- ◆ Haryana
- ◆ Jammu & Kashmir
- ◆ Punjab
- ◆ New Delhi
- ◆ Uttar Pradesh
- ◆ Rajasthan
- ◆ Madhya Pradesh
- ◆ Chhattisgarh
- ◆ Arunachal Pradesh
- ◆ Himachal Pradesh
- ◆ Sikkim
- ◆ Orissa
- ◆ Bihar



2 Lakh + Electricians | 2500 + Dealers

Corporate Office :

Unit No.9, Sati Industrial Estate, I. B. Patel Road,
Near Bank Of India, Goregaon (E), Mumbai-63. INDIA.

+91 99872 18145

info@elleys.group www.elleys.group

Hi-Fi[®]
electric

© Copyright 2022 by Hi-Fi



General Terms & Conditions :

- All Prices are in Indian Rupees ₹.
- Rates are inclusive of all taxes.
- Above rates are as per Unit.
- The above Prices are ex-godown.
- No replacement of module plates.
- This cancels all our previous Price-list.
- Company reserves the right to issue amendments, which may arise due to any errors in the Price List.
- Orders are subject to confirmation.
- Above prices are subject to change without any prior notice.
- MCB & electronic items has a warranty of one year only.
- It is important to fix electrical accessories from a certified electrician / contractors only.
- Subject to mumbai jurisdiction only.

If you have any query or would like to know more about our products, you can email us on :  sales@elleys.group

SCAN this QR-Code
with your smart phone